

A model for large-scale, in-service teacher training on effective technology integration in engineering education

Submitted in partial fulfilment of the requirements

of the degree of

Doctor of Philosophy

by

Jayakrishnan M

Roll Number: 124380002

Supervisors:

Prof. Sahana Murthy

and

Prof. Sridhar Iyer



Interdisciplinary Program in Educational Technology

INDIAN INSTITUTE OF TECHNOLOGY BOMBAY

May 2018

Approval sheet

This thesis report entitled 'A model for large-scale, in-service teacher training in effective technology integration in engineering education' by Jayakrishnan M is approved for the degree of Doctor of Philosophy.

Examiners

NJ Ka
Kanishk Boudh

Supervisor (s)

Pradip Kumar
Sridhar

Chairman

K. Jayakrishnan M

Date: 01-May-2018

Place: MUMBAI

Declaration

I declare that this written submission represents my ideas in my own words and where others' ideas or words have been included, I have adequately cited and referenced the original sources. I also declare that I have adhered to all principles of academic honesty and integrity and have not misrepresented or fabricated or falsified any idea / data / fact / source in my submission. I understand that any violation of the above will be cause for disciplinary action by the Institute and can also evoke penal action from the sources, which have thus not been properly cited, or from whom proper permission has not been taken when needed.



Jayakrishnan M

Roll Number: 124380002

Date: 1-May-2018

Abstract

The proliferation of information and communication technologies (ICT) has led to its widespread use in classrooms around the world in the last two decades. However for improved student learning the focus of teaching-learning practice has to shift from routine use of ICT for demo/display to effective ICT integration, that is, the comprehensive process of applying ICT to the curriculum to improve teaching-learning, that relies heavily on pedagogical design. Teacher professional development (TPD) programmes that focus on pedagogy related to integration of ICT in classroom to inform effective teaching practices are one way of providing this solution.

Two key issues related to TPDs in the Indian engineering education context are: (i) Reliance on in-service in-service short-term training programmes (STTPs) and (ii) Issue of large-scale. The number of in-service teachers existing within engineering education is around 0.5 million, introducing the need for scalable TPD programmes. Thus apart from the need for a good design, complexities may arise due to the scale. Thus the broad problem statement of this thesis is: *How to improve the design and delivery of large-scale training programmes to in-service faculty in Indian engineering education, to enable them in effectively integrating Information and Communication Technology (ICT) tools within their teaching-learning context?*

In order to address this problem, we have created the Attain-Align-Integrate-Investigate (A2I2) model for designing of technology integration training programmes. The A2I2 model has its theoretical basis on constructive alignment (Biggs, 1996), and it utilizes spiral curriculum (Bruner, 1960) and active learning (Prince, 2004) in its implementation. Design Based Implementation Research (DBIR) approach formed the methodological basis of this research. This model was used to design and implement five training programmes under the banner “Educational Technology for Engineering Teachers” (ET4ET) that got implemented across three different modes – face-to-face, blended online and massive open online mode. In line with the DBIR approach, evaluation studies conducted in each iteration informed us of the effectiveness of the training and also helped in refining the model. The evaluations were done on the metrics of reaction, learning, behaviour, participation rates while scaling and sustainability. Key results include (i) Participant teachers’

evaluations were done on the metrics of reaction, learning, behaviour, participation rates while scaling and sustainability. Key results include (i) Participant teachers' reporting attitude shift from teacher-centric to student-centric practices, (ii) Participants' showing increased perception of competency in the use of wikis, screencast and visualizations within their practice, and (iii) Medium-term sustainability of training benefits observed at the levels of teacher, student and institution. The iterative refinement of the A2I2 model also resulted in three design principles – *Pertinency, Immersivity and Transfer of Ownership* – that can be used to scale and sustain TPD efforts.

Keywords: Teacher Professional Development, Large-scale, Training Design, Design Based Implementation Research, A2I2

TABLE OF CONTENTS

Abstract	i
List of Figures	x
List of Tables	xii
Abbreviation Notation and Nomenclature	xv
Chapter 1	1
Introduction	1
1.1 Context of Research	1
1.2 Personal Motivation	3
1.3 Problem Statement	5
1.4 Solution Overview	6
1.4.1 A2I2 Model.....	7
1.5 Research Methodology adopted to create and evaluate A2I2 Model	9
1.6 Scope of Thesis	11
1.6.1 Goal and Duration of TPD programme.....	11
1.6.2 Target Audience of TPD programme.....	11
1.6.3 Type of Technology	11
1.7 Thesis Contributions	12
Contributions to Theory	12
Contributions to Practice	12
1.8 Organization of Thesis	12
Chapter 2	15
Review of Literature	15
2.1 Background and Context	16
2.2 Improving teaching-learning practices in engineering education	18
2.3 Challenges in teacher technology integration in engineering education	19
2.4 Teacher Professional Development	21
2.4.1 Theory of TPD.....	21
Key ideas and associated models for TPD	21
Recommendations and best practices for TPD.....	24
2.4.2 Existing training programmes	25
2.5 Evaluation of Training Effectiveness	26
2.6 Sustainability	27

2.7	Need for this thesis work.....	28
Chapter 3	31
	Research Design	31
3.1	Choosing an appropriate EDR methodology	33
3.1.1	Need for Educational Design Research (EDR) methodology	33
3.1.2	Why DBIR is an appropriate research methodology?.....	34
3.2	Implementation of DBIR in our context	37
3.2.1	Need for Exploratory Phase	37
3.2.2	Research flow within DBIR phase	38
3.2.3	Research-Practice Partnerships in our context.....	39
3.2.4	Application of DBIR Principles in our context.....	41
3.3	Research Questions	42
3.4	Data Collection, Analysis and Ethical Considerations	44
Chapter 4	47
	Exploratory Phase	47
4.1	Exploratory Study 1	48
4.1.1	Overview of the Training Programme.....	48
4.1.2	Research Design.....	49
	Research Questions.....	49
	Sample	49
	Instrument used	50
	Data Analysis Procedure.....	51
4.1.3	Results.....	52
	Result 1.1: Usefulness of active learning strategy	52
	Result 1.2: Conceptions about active learning strategy	53
	Result 1.3:Need for support in implementing active learning	54
4.2	Exploratory Study 2	55
4.2.1	Overview of the training programme	55
4.2.2	Research Design.....	56
	Research Questions.....	56
	Sample	56
	Instrument	57
	Data Analysis Techniques	58
4.2.3	Results.....	58
	Result 2.1: Low persistence rates comparable with rates observed in large-scale courses	58

Result 2.2: Low learning scores but statistically significant gain across assignments along with a strong perception of learning.....	59
Result 2.3: High perception of satisfaction from the workshop	59
Result 2.4: Rank Correlation coefficient (γ) = 0.75.....	59
4.3 Implication of the Results	59
4.4 Broad Training Goals	61
Chapter 5	63
A2I2 Model	63
5.1 Overview of the Model	64
5.1.1 Structural view of A2I2 model.....	64
5.1.2 Functional view of A2I2 model.....	65
5.2 Theoretical Basis	68
5.3 Evolution of the Model.....	69
5.4 Design Principles of A2I2 Model	71
5.4.1 Immersivity.....	71
5.4.2 Pertinency	72
5.4.3 Transfer of Ownership	72
5.5 The A2I2 Model	73
5.6 Operationalization of Design Principles during Implementation	77
5.6.1 Implementation of Immersivity in Training	77
5.6.2 Implementation of Pertinency in Training	77
5.6.3 Implementation of Transfer of Ownership via Classroom Action Research.....	78
Chapter 6	79
Implementation of Model – Face to face mode.....	79
6.1 Overview of ET4ET₀ (Iteration 1)	80
6.2 Research-Practice Partnership in Iteration 1	81
6.3 Implementation of Model in the Iteration 1	81
6.3.1 Catering to participant diversity.....	82
6.3.2 Catering to participants’ unfamiliarity with active learning	84
6.4 Research Study 1	84
6.4.1 Research Questions	85
6.4.2 Sample.....	85
6.4.3 Data Sources and Instruments.....	85
6.4.4 Procedure	86
6.4.5 Results.....	87

Result 1.1: Participants perceive high learning and are keen on applying the student centered strategies that they learnt during the training.....	87
Result 1.2: Participants show intention and use Active learning strategies in their final lesson plan.	88
Result 1.3: Participants are able to align Learning outcomes with Instructional strategies more than Assessment strategies.....	89
6.5 Reflections from the implementation.....	89
Chapter 7	91
Implementation of Model – Blended Online Mode	91
7.1 Design decisions taken in this mode	93
7.1.1 Choice of technology for training.....	94
7.1.2 Modifications in the blended learning environment.....	95
7.1.3 Model for adapting active learning strategies in Blended online mode	95
Adaptation of active learning strategy of Think-Pair-Share.....	97
7.1.4 Scaffolds for assisting participants during creation of artefacts	99
7.2 Iteration 2	100
7.2.1 Overview of the training - ET4ET ₁	100
7.2.2 Applying the model in a new setting.....	101
Implementation in Individual Session.....	101
Implementation in whole workshop.....	103
7.2.3 Research Study 2 – Effectiveness of ET4ET ₁	105
Research Questions.....	105
Sample	106
Data Source and Instruments.....	106
Data Analysis Techniques	107
Results	107
7.2.4 Reflections and Implications of Iteration 2	110
7.2.5 Training goals for next iteration	111
7.3 Iteration 3	111
7.3.1 Overview of the training – ET4ET ₂	111
7.3.2 Refinement in the Model	113
Introduction of design principle of Pertinency	113
Introduction to design principle of Immersivity	114
Immersivity and Pertinency as substitute indicators for sustainability	114
Implementation of A2I model for training in wikis.....	117
Addition of Investigate Phase.....	118
7.3.3 Research Study 3 – Effectiveness of ET4ET ₂	119

Research Questions.....	119
Sample	119
Data Sources and Instruments.....	120
Procedure.....	121
Data Analysis Technique	121
Results	122
7.3.4 Reflections and Implications of Iteration 3	126
7.4 Iteration 4	127
7.4.1 Overview of the training ET4ET ₃	128
7.4.2 Refinement in the Model	128
7.4.3 Research Study 4 – Sustainability of Training.....	129
Research Question.....	129
Sample	129
Instruments.....	129
Data Analysis Techniques	129
Results	129
7.4.4 Reflection from Iteration 4 _{bo}	131
7.5 Reflections from the Blended Online Implementation.....	131
Chapter 8	133
Implementation of Model – Massive Open Online Mode	133
8.1 Overview of ET4T₄(Iteration 5)	134
8.2 Implementing A2I2 Model in MOOC	135
8.2.1 Pedagogic Design.....	136
Learning Dialogue (LeD) Videos	137
Learning by Doing (LbD) Activities	138
Forums for Learning experience Interactions (LxI).....	139
8.2.2 Implementing design principles of A2I2 model in a MOOC setting.....	140
Pertinency in ET601Tx.....	140
Immersivity in ET601Tx.....	141
8.3 Evaluation of ET4ET₄.....	141
8.3.1 Research Question	141
8.3.2 Research Method.....	141
8.3.3 Results.....	142
Result 5.1: 67.4% Active Participants and 36.58% completion rates	142
Result 5.2: 5023 Threads started and 9861 comments by participants across 8 week..	142
Result 5.3: An average of 399 participants accessed the course daily.....	143

Result 5.4: High relevance and usefulness for LeD Videos, LbD Activities and Discussion Forums.....	143
8.4 Reflections from Iteration 5	144
Chapter 9	145
Discussions and Recommendations	145
9.1 Summary of Results.....	147
9.1.1 Persistence rates while scaling.....	147
9.1.2 Reaction of participants after training	147
9.1.3 Learning of participants after training.....	148
9.1.4 Behaviour of participants after training.....	149
9.1.5 Sustainability of Training.....	149
9.2 Interpretation of Results	150
9.3 Implications of Results.....	151
Researchers.....	151
Trainers and Administrators.....	152
Teachers.....	152
Technology Developers.....	152
9.4 Claims and Evidence.....	153
9.5 Generalizability.....	154
9.6 Limitations.....	155
9.7 Recommendations	155
Chapter 10.....	159
Thesis Contributions and Future Work.....	159
10.1 Contributions of the Research.....	160
10.1.1 Contributions to theory.....	160
• A2I2 Model for design and implementation of teacher technology integration training programmes	160
• Design principles of Pertinency, Immersivity and Transfer of Ownership.....	160
• A model for adaptation of active learning strategies in synchronous-remote mode 160	
10.1.2 Contributions to Practice.....	161
• Activity constructors for assisting teachers in technology integration	161
• Training resources for other trainers.....	161
• Portals for building Communities of Practice	161
10.2 Directions for Future Work	161
10.2.1 Extending A2I2 for synchronous collaboration tools	161

10.2.2	Exploring the application of A2I2 based training programs to extend sustainability of training benefits	162
10.2.3	Extending A2I2 model to incorporate content knowledge for developing training for novice teachers.....	162
PUBLICATIONS FROM THESIS		163
REFERENCES		165
APPENDICES		166
ACKNOWLEDGEMENT		167

List of Figures

Figure 1.1: Overview of the A2I2 Model	7
Figure 1.2: Functional view of A2I2 Model	8
Figure 1.3: Iterations of DBIR followed in development of A2I2 model	10
Figure 2.1: Flow of Literature Review	16
Figure 2.2: Three pathways to develop TPACK.....	23
Figure 3.1: Overview of Multi-phase Mixed-methods Research (MMR).....	32
Figure 3.2: Flow of research in this thesis for solving the problem of practice through DBIR.....	37
Figure 3.3: Single Iteration within DBIR	38
Figure 3.4: Research-Practice Partnerships in Design Research (Kali, 2016).....	40
Figure 4.1: Training environment facilitating blended mode of instruction in T10kT programmes.....	49
Figure 4.2: Varying conception of Active Learning among Engineering instructors..	54
Figure 5.1: Structural view of the A2I2 Model.....	64
Figure 5.2: The design-implement-evaluate-refine cycle of model using DBIR methodology	70
Figure 6.1: Implementation of iteration in DBIR	79
Figure 6.2: Content of slides for session on 'Learning outcomes' designed for catering to diversity	83
Figure 6.3: Implementation of Pertinency in creation of assignments	83
Figure 6.4: Applying design principle of Immersivity to train teachers in Peer Instruction strategy.....	84

Figure 6.5: Participants' perception of usefulness of training content in ET4ET ₀ (N=21).....	87
Figure 6.6: Participants' perception of Learning from ET4ET ₀ (N=21).....	88
Figure 6.7: Participants' intention to apply the learning from ET4ET ₀ (N=21)	88
Figure 7.1: Training environment provided by T10kT	92
Figure 7.2: Iterations of training in the blended learning mode	93
Figure 7.3: Modification made in T10kT training environment for ET4ET	95
Figure 7.4: Model for adapting active learning strategy in blended online mode	96
Figure 7.5: Think-Pair-Share Activity Constructor, showing portions relevant to think phase	99
Figure 7.6: Training schedule for Iteration 2 _{bo}	100
Figure 7.7: Overview of Iteration 3	111
Figure 7.8: Schedule for ET4ET ₂ in Iteration 3	113
Figure 7.9: Results related to pertinency of training content.....	125
Figure 7.10: Implementation of ET4ET ₄ in Iteration 4.....	128
Figure 8.1: Reflection Spot in an LeD Video	137
Figure 8.2: An LbD activity with detailed explanation to reinforce the concepts learnt	139
Figure 8.3: Discussion Forums for sharing learner experiences.....	140
Figure 8.4: Daily participation of users in ET601Tx.....	143

List of Tables

Table 1.1: Overview of Training Programmes designed and im-plemented from A2I2 Model	6
Table 1.2: Evaluations done across various iterations in this thesis	10
Table 2.1: Levels of Inquiry in Engineering Education (adapted from Strevler et.al., 2012)	19
Table 3.1: Types of EDR Studies and their Outputs (adapted from (Plomp,2013))....	34
Table 3.2: DBIR Questions and methods mapped against phase of research (Penuel, 2015)	36
Table 3.3: Overview of implementation mode, scale and technologies trained within the DBIR	39
Table 3.4: Metrics being evaluated within this DBIR iterations and corresponding RQs	44
Table 3.5: Data Sources / Instruments used in our DBIR methodology.....	45
Table 4.1: Overview of the training programmes in the exploratory phase	47
Table 4.2: Example of coding scheme of instructor conceptions of active learning ...	52
Table 4.3: Frequency of perception about teacher acceptance and teacher confidence in active learning and visualization.....	53
Table 4.4: Conception of active learning vs Need for support in implementing active learning	54
Table 5.1: Functional View of the model	66
Table 5.2: An overview of evolution of the A2I2 model.....	69

Table 5.3: Features of A2I Model.....	75
Table 5.4: Elaboration of format of activities in A2I2 Model.....	76
Table 6.1: Schedule for training in Iteration 1.....	81
Table 6.2: Features of A2I Model for designing training programmes (Iteration 1)...	82
Table 6.3: Format of activities in A2I model (Iteration 1 _{f2f}).....	82
Table 6.4: Sample Rubric element for evaluation of lesson plans.....	86
Table 6.5: Intention to Use and Actual Use of strategies in lesson plan.....	89
Table 6.6: Mean Scores for Alignment in the lesson plans as per the lesson planning rubric (Iteration1).....	89
Table 7.1: Organization of research studies across this chapter.....	93
Table 7.2: Design of an individual session using A2I Model.....	102
Table 7.3: Design of an entire technology integration training using A2I model.....	103
Table 7.4: Frequency of Assignment Submission.....	107
Table 7.5: Attendance data of synchronous sessions from the remote centers.....	108
Table 7.6: Preferred month for attending training.....	108
Table 7.7: Participants' perception on learning (N=178).....	108
Table 7.8: Perception of competence of using wikis (Post intervention survey results, N=129).....	109
Table 7.9: Correlation between perceptions of design, implementation and evaluation of wiki.....	110
Table 7.10: Design of an entire session using modified A2I model.....	117
Table 7.11: Constructs, Data Source and Metrics for the research study.....	120
Table 7.12: Assignment Completion data.....	122

Table 7.13: Prior exposure of participants' towards the chosen technologies	122
Table 7.14: Perception of competence in use of technology before and after training	123
Table 7.15: Scores of wiki based lesson plan analysis of the participants	123
Table 7.16: Data related to immersivity of the training.....	124
Table 8.1: Description of ET801Tx	134
Table 8.2: Overall Schedule of ET4ET ₅ based on A2I2.....	136
Table 8.3: Details of data sources, instruments and data analysis techniques.....	142
Table 8.4: Relevance and Usefulness of Pedagogical Features in ET601Tx	143
Table 9.1: Mapping of broad research questions to the research questions in individual iterations.....	146
Table 9.2: Summary of Results for RQI	147
Table 9.3: Summary of results related to RQII.....	148
Table 9.4: Summary of Results for RQ III	148
Table 9.5: Summary of results related to RQ V.....	149

Abbreviation Notation and Nomenclature

A2I2	Attain-Align-Integrate-Investigate
AL	Active Learning
AS	Assessment Strategy
A-VIEW	Amrita Virtual Interactive E-learning World
BO	Blended Online
CAR	Classroom Action Research
F2F	Face-to-face
ICT	Information and Communication Technology
IIT	Indian Institute of Technology
IS	Instructional Strategy
LO	Learning Outcome
MOOC	Massive Open Online Course
MOODLE	Modular Object-Oriented Dynamic Learning Environment
NMEICT	National Mission on Education through use of ICT
RPP	Research Practice Partnership
SOTL	Scholarship of Teaching and Learning
SRC	Synchronous Remote center
STTP	Short-Term Training Programmes
T10kT	Train 10000 Teachers
TPACK	Technology, Pedagogy and Content Knowledge

TPD	Teacher Professional Development
TPDP	Teacher Professional Development Programme

Chapter 1

Introduction

1.1 Context of Research

The proliferation of information and communication technologies (ICT) has led to its widespread use in classrooms around the world in the last two decades (Spiezia, 2011;Wastiau et. al., 2013). However even with its widespread use there are insignificant results related to effectiveness of student learning in terms of student satisfaction, attitudes and learning outcomes (Johnson & Aragon, 2003; Banerjee, Murthy and Iyer, 2015). These indifferent results are due to the fact that effective learning with ICT is primarily dependent on pedagogical design of use of ICT (Mandell, Sorge & Russell, 2002). Thus the focus has to shift from routine ICT use for demo/display to effective ICT integration, where ICT integration is defined as the comprehensive process of applying ICT to the curriculum to improve teaching-learning, that relies heavily on pedagogical design (Wang & Woo, 2007). The rapid proliferation of ICT resources have also compounded the problems related to effective integration, as the teachers have to additionally tackle the steep learning curve of these technologies before integrating them in their teaching-learning practice.

One of the possible solutions to this problem is teacher professional development programme (TPDP) that focus on pedagogy related to integration of ICT in classroom to inform effective teaching practices. Most of these efforts are done for pre- or in-service teachers at the school level, but there are fewer systemic efforts at the college

and university level (Schaefer & Utschig, 2008). At the tertiary education level, decisions for ICT integration is often left to the individual instructors (Shaffer, Akbar, Alon, Stewart, & Edwards, 2011), leading to problems such as ineffective use of the tool (Selwyn 2007), isolation and inability of individuals to find know-how (Conole, Dyke, Oliver & Seale 2004), and lack of percolation of good practices (Ebert-May, Derting, Hodder, Momsen, Long, & Jardeleza, 2011). TPDs assume greater significance in the Indian engineering education context as appointment of teachers in engineering colleges is done based on their qualifications (University Grants Commission, 2010) and do not mandate a pre-service training. These teachers are only provided with a 1-2 week induction program to familiarize them with the foundations of learning theories and pedagogic practices essential for effective teaching-learning (Pal, 2009; National Knowledge Commission, 2009). Thus the in-service engineering teachers have to rely on in-service short-term training programmes (STTPs) to improve their teaching-learning skills using ICT.

However even with a well-designed TPDP, the above problems get compounded when they have to be implemented at a large-scale. Complexities due to the scale include the availability of infrastructure, diversity in operating conditions, and resources available and ensuring engagement and learning. The challenges faced by a policy maker in education (could be a Minister of Education or his office), an administrator in a large university (or similar higher education system) or members of civil society (like Alumni, involved in improving quality of their alma-mater) will be similar and hence would be an important problem for them to identify better solutions. The Train 10000 Teachers (T10kT) project, under the National Mission on Education through ICT (NMEICT), is a similar large-scale effort designed to promote large-scale professional development programmes for university faculty in various topics. The Indian Institute of Technology (IIT) Bombay is spearheading this effort along with support from IIT Kharagpur to target the teachers from engineering colleges across the country. This thesis is situated primarily in the context of large-scale efforts associated with the T10kT project.

Much like the higher education system worldwide, the Indian higher education has seen massive growth in the past two decades along with increased student enrollment (Kapur, 2012). This growth is also associated with increase in the number of problems

related to quality of teaching-learning interactions, structural issues like administration and financing, affordability issues etc. (Pal, 2009). With the existing diversity of higher education institution, the Indian higher education system can be considered as a representative for higher education worldwide. Within the Indian higher education, it is the engineering education that has seen maximum growth with the total number of institutions catering to undergraduate studies increasing to 6430 (from around 600 in 2000) and having close to 0.6 million teachers (AICTE, 2016). This sudden spurt has resulted in the engineering education experience the quality and structural issues, leading to government interventions like NMEICT. Thus it is a representative segment to examine the impact of efforts to reduce problem of technology integration in the landscape of higher education within India. My situatedness within Indian Institute of Technology Bombay, a higher educational institution for engineering, additionally allows me to examine the interventions upclose.

1.2 Personal Motivation

While doing my undergraduate degree in Electrical Engineering, I realized that teachers in engineering faced several more issues than teachers at school level as the concepts became much harder and abstract for regular learners. As a student, my approach to tackle this issue was to create study groups with friends, where the concepts could be discussed and taught to those who were unable to understand it. I primarily relied on strategies like creating mindmaps, analogies etc., as use of technology was not ubiquitous at that time. Even then while learning subjects like Electrical Machines and Power Systems, our group had used lot of videos and simulations to clarify key concepts. Though I wasn't familiar with formal definitions of co-operative learning, model based reasoning, meaningful learning through ICT etc., the power of using technology along with effective strategies were evident to me.

I was able to further explore the use of technology in learning when I joined for M.Tech at Centre for Technology Alternates for Rural Areas, IIT Bombay (CTARA, 2007). The philosophy of CTARA was on the use of appropriate technology for development of people at the bottom of the pyramid. This philosophy had a personal appeal to me as I had witnessed the impact of improvements in health and education

while growing up in my home state Kerala. So there was no doubt in my mind to select education as my focus area for my M.Tech dissertation. I started exploring large-scale government interventions for technology use in education and few of my acquaintances, back home, directed me to the IT@School Project. This was a project initiated by Government of Kerala to implement technology-enabled instruction across the state (IT@School, 2001). The state on its part had introduced a separate subject called Information and Communication Technology in the curriculum with a mandate that all the teachers be required to teach this subject from grade 5 onwards. The project had provided ICT resources to all government schools and provided training to all the teachers. The trainers, who were called Master Trainers, were teachers who were identified as champion users of ICT by the education department and duly relieved of their teaching duty to solely focus on training their peers. The trainings within this project were targeted towards empowering the teachers to use technology, first for teaching the subject ICT, and second to explore the opportunities to teach within their own course. I had visited 12 schools and interviewed 25 teachers (including 3 Master Trainers) and 20 students to understand the impact of these measures. Again it was visible that teachers who tried to incorporate strategies by involving the students in the use of technology were finding better results. However these teachers represented a small minority within a school, with others being daunted by introduction of technology.

Exposure to such a project initiated at the school level had made me think about efforts needed at engineering education level even more. It was during this time that the report on low employability of Indian engineering graduates was being discussed (McKinsey, 2009) at lengths, and government had actively begun addressing some of the concerns by providing ICT resources to higher educational institutions. My exposure to IT@School implementation had helped me realize that access to technology per se will not get translated to effective use and these need to be supplemented with adequate efforts for implementing structures and training programmes that expose the teachers to effective use of various ICT resources. Though creation of structures were beyond my scope, my location within IIT Bombay, one of the premier institutes in undergraduate engineering education, provided me with an ideal platform to explore the answers to the question – “Can an

in-service engineering college teacher, irrespective of his/her experiences, be trained to become effective in integration of ICT within their classroom?”

1.3 Problem Statement

Existing research on teacher technology integration sheds light on the presence of barriers that prevent instructors from effectively integrating technology in classrooms. Ertmer (1999) has classified these barriers into first and second order, based on how they act on the teacher. The first order barriers are external to the teacher and include access to technology, training and support. The second order barriers are intrinsic and include variables like teacher’s confidence and beliefs about how students learn, and the value of technology. This classification was extended by Tsai and Chai by adding a third order barrier (Tsai & Chai, 2012), which deals with the teachers’ competency in designing effective learning activities within the constraints of the learning environment.

With intervention of several government and private agencies, the first order barrier has slowly been reduced (Spiezia, 2011;Wastiau et. al., 2013). In the case of Indian engineering education, initial evaluation report of the NMEICT initiative concur that the problem of access has been greatly reduced, and recommend better TPD programmes aimed at improving teaching-learning practices (Mehta, Pawar, Kincha, Gautam, & Bandyopadhyay, 2012). The number of in-service teachers existing within engineering education is around 0.5 million (AICTE, 2016), introducing the need for scalable TPDPs. Thus the TPD efforts for ICT integration within Indian engineering education has to now focus on removing the second and third order barriers at scale to facilitate better teaching-learning practices.

Thus the broad problem that I am trying to address in this thesis is: *“How to improve the design and delivery of large-scale training programmes to in-service faculty in Indian engineering education, to enable them in effectively integrating Information and Communication Technology (ICT) tools within their teaching-learning context?”*

1.4 Solution Overview

In order to address this broad problem of ineffective teacher technology integration I, along with my thesis supervisors Dr. Sahana Murthy and Dr. Sridhar Iyer, have created the Attain-Align-Integrate-Investigate (A2I2) model for designing of technology integration training programmes for teachers in engineering education. This model was used to design and implement five training programmes under the banner “Educational Technology for Engineering Teachers” (ET4ET) that got implemented across three different modes – face-to-face, blended online and massive open online mode. The details of the training programmes implemented in each mode are detailed in Table 1.1 below:

Table 1.1: Overview of Training Programmes designed and implemented from A2I2 Model

Training Iteration	Iteration 1 (ET4ET ₀)	Iteration 2 (ET4ET ₁)	Iteration 3 (ET4ET ₂)	Iteration 4 (ET4ET ₃)	Iteration 5 (ET4ET ₄)
Schedule	Jun 24 - 28, 2013	Synchronous Jun 12 - 14, Jul 24 - 26, 2014 Asynchronous Jun 14 - Jul 23 Jul 27 - Aug 2 2014	Synchronous Jan 5 - 7, Jan 19 - 21 2015 Asynchronous Jan 5 - Jul 23 Jan 22 - Jan 30 2015	Asynchronous Jun 1 - Oct 23, 2016 Oct 24 - Face-to-face Oct 24 - 26, 2016	Jan 7 - Mar 7, 2016
Mode	Face-to-Face	Blended Online			Massive Open Online
Number of Participants	23	1300	4358	51	5105
Scale	1x	~56x	~189x	~2x	~221x
Focus of training	Technology Integration	Scaling Technology Integration	Scaling Technology Integration	Sustaining Technology Integration	Scaling Technology Integration
Technologies Trained	Visualization	Visualization, Wiki, Screencast	Visualization, Wiki, Screencast	Wiki, Padlet	Visualization

I have then evaluated the model across the dimensions of Persistence Rates, Participant Reaction, Participant Learning, Participant Behaviour and Sustainability to ensure its effectiveness. The model was continuously refined on the basis of evaluation of individual training programmes. The solution has utilized the existing delivery mechanisms to facilitate scaling up interventions. A total of 10,634 participants were trained through these programmes in technologies like Visualizations, Screencasts, Wiki and Padlet.

1.4.1 A2I2 Model

The A2I2 model has its theoretical basis on constructive alignment (Biggs, 1996), and it utilizes spiral curriculum (Bruner, 1960) and active learning (Prince, 2004) in its implementation. The model consists of three design principles – Pertinency, Immersivity and Transfer of ownership that will provide guidelines to selection and design of training content and activities. Figure 1.1 (below) shows an overview of the A2I2 model, indicating the four phases and contents that are dealt within it. As seen from the figure the four contents of Learning objective (red circle), Instructional Strategy (blue circle), Assessment Strategy (yellow circle) and Technology (white rhombus), are integrated across the first three phases of Attain, Align and Integrate, to create a lesson design. This lesson design is then examined for teaching-learning effectiveness in the Investigate phase (violet triangle) by generating an action research idea on it.

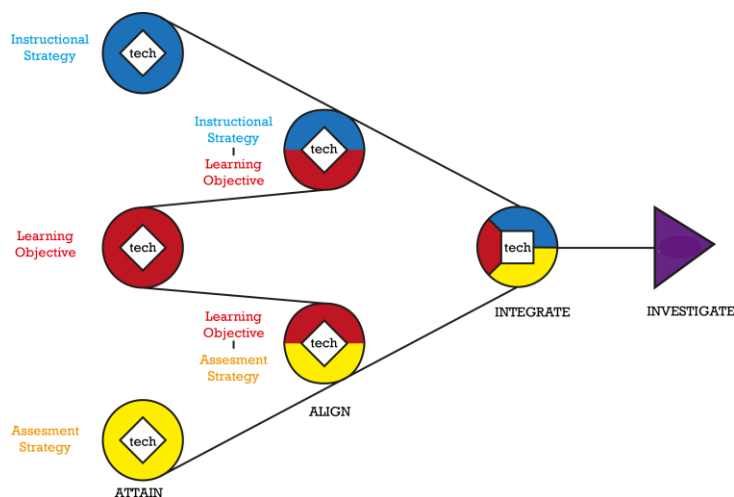

Figure 1.1: Overview of the A2I2 Model

The term 'Learning Objectives' have been used in this model to refer to the idea of creating student-centered, specific and measurable outcomes related to the teaching-learning practice. The term “Learning outcomes”, which is more widespread due to accreditation process followed in our context to refer to the same idea, has been used in this thesis from here onwards.

This model assists a training designer to design and implement a training programme for technology integration by providing guidelines on five key features –Focus of training in each phase, Content of training, Format of activities during training, Level

of Immersion of technology in each phase and Pertinent Output for the phase. A functional view of the model with three key features is provided in Figure 1.2 below. The design principle of *Immersion* informs the feature of ‘Level of Immersion’ and the design feature of *Pertinency* informs ‘Pertinent Output’. The design feature of *Transfer of Ownership* is completely applied in the ‘Investigate’ phase. The focus of each phase is identified as the larger training goal to which the activities in that phase needs to be oriented to. Level of immersion and pertinent output are features that assist in operationalization of training activities by providing guidelines on technology use by participants and the type of artifacts to be created during the training. The model additionally gives recommendations on the type of activities in each phase by specifying whether they are individual or group work. For instance, key features of A2I2 model informs a trainer that in the ‘Attain’ phase the focus of training activities should be to introduce participating teachers to the idea of student-centeredness. This can be operationalized by allowing participants’ to explore the technology as a student (level of immersion), leading to creation of independent learning artifacts (pertinent output).

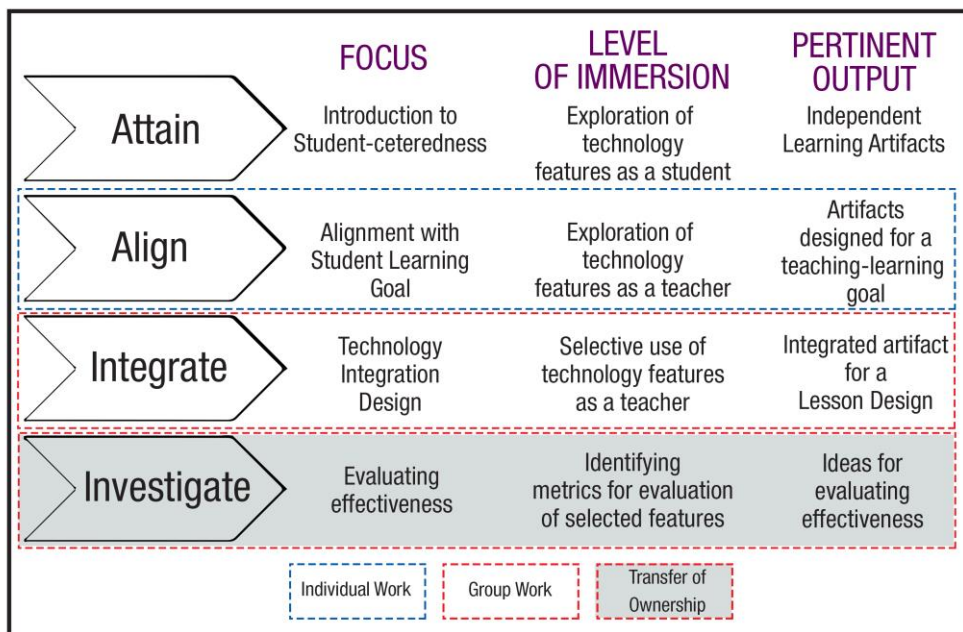

Figure 1.2: Functional view of A2I2 Model

1.5 Research Methodology adopted to create and evaluate A2I2 Model

To create and evaluate the A2I2 model, I have used the Design Based Implementation Research, which is under the umbrella of Educational Design research methods. The core principles that characterizes DBIR methods are (Penuel et. al., 2011):

- I. Focus on persistent problems of practice from multiple stakeholders' perspectives
- II. A commitment to iterative, collaborative design
- III. A concern with developing theory and knowledge related to both classroom learning and implementation through systematic inquiry
- IV. A concern with developing capacity for sustaining change in systems.

The broad objective of the A2I2 model is to solve the problems technology integration for engineering college teachers through design and development of training programmes that can be scaled. If we look from the perspectives of multiple stakeholders – Teachers, Administrators and Trainers, the thesis is focusing on solving key problems of practice (Principle I) for each of them. The analysis of training requires inputs from participating teachers that are further used in improving the model, thereby creating a commitment for a collaborative and iterative design (Principle II). The model provides avenues for participating teachers to explore and evaluate learning designs and thereby contribute to the theory and knowledge related to technology integration practice (Principle III). By developing a scalable model, the thesis is trying to increase the capacity of the system and ensure that changes in the system sustain beyond immediate practice (Principle IV). Thus the methodology of DBIR is appropriate for this thesis.

Figure 1.3, shows the evolution of the A2I2 model across an exploratory phase followed by five iterations of design and implementation of training programmes using DBIR methodology. These trainings were offered in three different modes of implementation (face-to-face, blended online and massive open online). Evaluation and analysis of training in each of these iterations provided inputs to the refine the A2I2 model and thereby into design of next iteration of training.

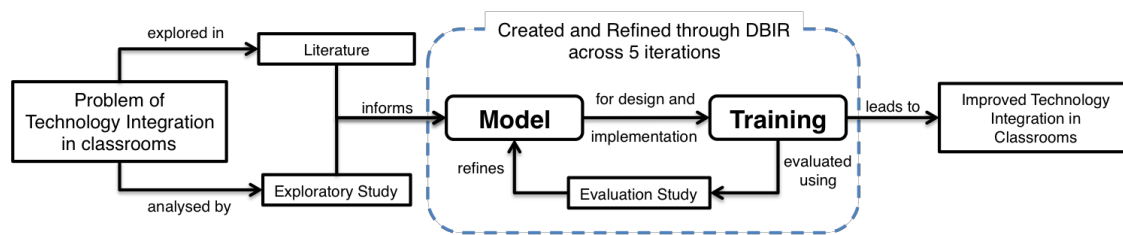

Figure 1.3: Iterations of DBIR followed in development of A2I2 model

Five broad evaluation questions were investigated to identify the effectiveness of our solution (A2I2 Model) in addressing the broad problem of teacher technology integration and scaling.

EQI. What is the perception of participants' at the end of training designed based on A2I2 model?

EQII. What is the learning of participants' at end of training designed based on A2I2 model?

EQIII. What is the post-training behaviour of participants who attended the training designed based on A2I2 model?

EQIV. What are the persistence rates when the training is scaled using A2I2 model?

EQV. How sustainable are the training benefits of the training programmes designed based on A2I2 model?

EQVI. DBIR provides us with the flexibility to use multiple methods to examine each of these research issues across all the iterations. In this thesis, as seen from Table 1.2 above, I have evaluated effectiveness of training programmes along the levels of Reaction, Learning, Behaviour (Kirkpatrick, 1996), and Persistence rates across the iterations. Though long-term sustainability is beyond the scope of this thesis, I have looked into medium-term sustainability to identify effect of training on the inquiry practices of the teachers.

Table 1.2: Evaluations done across various iterations in this thesis

Iteration (Training)	Iteration 1 (ET4ET ₀)	Iteration 2 (ET4ET ₁)	Iteration 3 (ET4ET ₂)	Iteration 4 (ET4ET ₃)	Iteration 5 (ET4ET ₄)	
Mode	F2F	Blended Online			Massive Open	
Number of Participants	23	1138	4358	51	5105	
Evaluation	Perception	✓	✓	✓	-	✓
	Learning	✓	-	✓	-	-
	Behaviour	-	-	✓	-	-
	Persistence	-	✓	✓	-	✓
	Sustainability	-	-	✓	✓	-

1.6 Scope of Thesis

Design and implementation of teacher professional development programmes involve multitude of variables viz. scale, domain of participants, demographic variables associated with participants (age, gender, experience etc.), technology choice for training, mode and duration of training. To demarcate the boundaries of the current research, I scope these variables across three dimensions.

1.6.1 Goal and Duration of TPD programme

In this thesis, I scope myself to design of short-term training programmes targeted towards effective technology integration. By short-term, I mean training programmes having duration between 12-15 contact hours per technology in face-to-face mode. Also by focusing strictly on technology integration training, I am assuming that participating teachers will have mastery in the content. For example, A2I2 can be used to train teachers in use of technology like Simulink® for carrying out teaching-learning in a subject like “Embedded System Design”, but A2I2 model cannot be used to design a training programme focused on teachers learning the concepts of “Embedded System Design”. Though I have not tested the model explicitly, the thesis argues that the model will be suitable for designing training programmes for learners in acquiring skills related to practice. Technology integration can be considered as an instantiation of a skill for the learner category – Teachers.

1.6.2 Target Audience of TPD programme

In this thesis, I limit to design of training programmes for engineering college teachers. Though important, we have not explored the relation of demographic variables like age, gender, experience etc. on the training effectiveness and consider these outside the scope of the thesis. Since technology integration practices are similar, we can argue that this model will be equally applicable for training school teachers (pre-service training) as well. However in this thesis we have not tried to validate this generalization.

1.6.3 Type of Technology

In this thesis I have explored use of technologies that assist content curation, facilitation and asynchronous collaboration as the focus was on increasing

effectiveness of technology integration in a teacher-mediated classroom that are more common in the context. The technology tools that assist in synchronous collaboration or that has associated hardware components have not been explored in this thesis.

1.7 Thesis Contributions

Contributions to Theory

1. A2I2 Model with features and format of activities – The model can be used by other teacher technology integration trainers for designing their own training programmes
2. Design principles of Immersivity, Pertinency and Transfer of Ownership – These design principles are reusable and provide orientation towards creating scalable and sustainable training designs
3. A model for adaptation of active learning strategies in synchronous online mode – The synchronous online mode, similar to web-conferencing, is a major mode used to scale training programmes in this research. The thesis provides detailed guidelines for adapting active learning strategies utilized in a face-to-face setting to synchronous online mode without reducing their perceived effectiveness.

Contributions to Practice

1. Training Materials for Teacher Technology Integration – The training materials include schedules, videos, slides and activity constructors, which can be used by both administrators and trainers for creation of new training programmes or as references.
2. Three Portals for Community of Practice – The research has also helped in creating three portals in Wikispaces, Wordpress and Facebook platforms for engaging the community of practice.

1.8 Organization of Thesis

Chapter 2 contains literature review that explores the positioning of current work and sets up the goals of the training program. The research methodology of Design Based Implementation Research is then explained in chapter 3 and is followed by the details of exploratory phase undertaken to characterize the problem in chapter 4. The Attain-Align-Integrate-Investigate (A2I2) model, our solution, is then described in Chapter 5

in detail. The Chapters 6-8 describes the design, implementation and evaluation of A2I2 model in three different modes. Detailed discussions of results are done in Chapter 9 along with recommendations based on the implementation experience. Chapter 10 provides a conclusion of the thesis along with scope for future work.

Chapter 2

Review of Literature

In Chapter 1, the broad research problem of this thesis was identified as the design and implementation of large-scale training programmes for technology integration in engineering education. This requires me to first review existing research in the following key areas – Improving teaching-learning practices in Engineering Education, Teacher Technology Integration and Teacher Professional Development (TPD). I identified these research articles by reviewing journals indexed in Scopus (<http://www.scopus.com>), ScienceDirect (<http://www.sciencedirect.com>) and Web of Science (<https://webofknowledge.com>). Most articles included in the review were published after the year 2000. Exceptions were made only if the article reported a seminal work in the field. This chapter summarizes and synthesizes the relevant literature in the above areas, to position the need for the work undertaken in this thesis.

Figure 2.1 below shows an overview of the flow of literature review. In the initial section (Section 2.1), I describe the background and context of the research. Two broad problem areas emerge from the context – Improving teaching-learning practice in engineering education (Section 2.2) and assisting engineering educators in technology integration within their teaching-learning practice (Section 2.3). In section 2.4, we provide a detailed description of TPD approaches that are found to be a common strategy to solve the identified problems. To do this an analysis of existing models and best practices of TPD is done in section 2.4.1, followed by synthesis of

literature related to existing TPD programmes on technology integration in 2.4.2. The analysis of existing programmes helps in looking at training effectiveness evaluation (section 2.5) and further into sustainability of TPD benefits (section 2.6). In section 2.7, I synthesise all these analysis to present the need for this research.

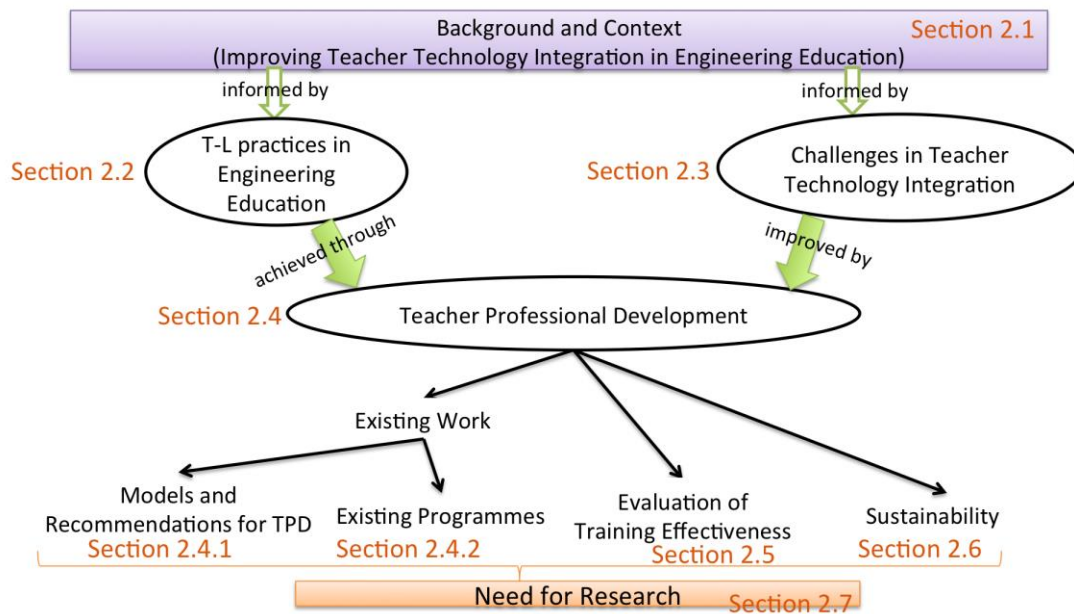

Figure 2.1: Flow of Literature Review

2.1 Background and Context

India has a total of 3288 engineering institutions with 0.4 million teachers catering to nearly 1.55 million students at the undergraduate level (AICTE, 2016). Two-thirds of these engineering institutions were found to be of low or middling quality (National Knowledge Commission, 2015), and it has become an important agenda for the Indian government to work towards improving the status of higher education. The National Mission on Education through ICT (NMEICT) is an important initiative aimed at addressing this agenda (MHRD, 2009). During the first five years the mission was able to provide broadband connectivity to 400 universities and 26000 colleges (MHRD, 2014). The Train 10000 Teachers (T10KT) project, under NMEICT, has been created to address the issue of providing large-scale training of teachers in domain, pedagogy and technology (Atrey, Parmar, Shiriskar, & Dhebar, 2016). In a six-year period from 2009 till 2015, the project had conducted 27 workshops training 80,556 teachers.

The current institutional mechanisms for organizing TPDPs for engineering faculty are Academic Staff Colleges and Quality Improvement Programmes by premium institutes, like various Indian Institutes of Technology (University Grants Commission, 2007). The number of attendees to these TPD programmes is limited to 20-50 in a single offering leading to a big gap between the demand and supply (Kannan & Narayanan, 2010). Additionally, many higher education institutes provide a 1-2 week induction program, for their newly joining teachers, to familiarize them with the foundations of learning theories and pedagogic practices essential for effective teaching-learning (Pal, 2009; National Knowledge Commission, 2009). Thus the in-service engineering teachers have to rely on in-service training programmes (STTPs) to improve their teaching-learning skills using ICT.

The T10KT team utilizes a “hub and spoke” model for delivering 2-week equivalent synchronous short-term training programmes to the participants coming together in the various engineering colleges (termed as “remote centers”) across the country. The training included sessions by experts, which are transmitted synchronously in the remote centers, with live two-way audio-visual interaction. Typical training programme also contain tutorials and labs conducted by ‘remote center coordinators’. In addition to the interaction, Moodle is used for asynchronous interaction, such as for assignments and quizzes. All training materials, including slides, assignments and videos of the lectures, are released in open source. Across the period of this research the number of remote centers associated with T10KT had risen from 148 to 248 and total number of unique participants trained had reached 80,556 (Atrey, Parmar, Shiriskar, & Dhebar, 2016). To further scale the effort, the T10kT project have utilized a MOOC platform, named IITBombayX (IITBX), for promoting blended mode of instruction to the larger group of institutions in India (Phatak, 2015).

Initially, the training programmes under T10KT are on specific domain-based topics, in various fields of engineering (such as Thermodynamics for Mechanical Engineering, Electronics for Electrical Engineering). An important need recognized was for a training program for engineering faculty focusing on pedagogical practices, and use of ICT in their teaching. The current research fills this gap by providing training on research based student-centric teaching practices for effective integration of ICT at scale.

2.2 Improving teaching-learning practices in engineering education

To position my work in the context of engineering education research, I first explore the general recommendations available for improvement of teaching-learning practices for engineering educators.

The outcome based approach described in the Washington Accord, signed by several countries including India, have generated necessity to equip engineering graduates with a set of process and awareness skills (Shuman, Besterfield-Sacre, & McGourty, 2015). The process skills include higher order thinking skills required to solve open-ended problems that are encountered by engineers in their workplace. The instructors in engineering disciplines would hence be required to focus on methods that will assist in complex and ill-structured problem solving and thereby leading to easier workplace transfer (Jonassen, Strobel, & Lee, 2006). Educational research on student-centered activities, like the varying forms of active learning, problem based learning or cooperative learning etc, provide evidence of significant improvements in student acquisition of these higher-order thinking skills (Prince, 2004). This would imply that the teaching practice in engineering requires a shift from the traditional lecture-based deductive approaches to more student-centered inductive approaches that focuses on acquisition of process and awareness skills (Prince & Felder, 2006).

Three levels of teaching-learning practices were initially proposed for engineering instructors – Effective Teaching, Scholarly Teaching and Scholarship of Teaching and Learning, based on the way teachers practice their teaching (Hutchings & Shulman, 1999). These levels were further refined by addition of two extreme ends viz. Normal Teaching and Engineering Education Research (Steveler, Smith, & Pilotte, 2012). These are summarized in Table 2.1 (in next page). For effective engineering teaching-learning practice it is desired that engineering instructors should consistently engage themselves at or above scholarly teaching practices (Wankat, Felder, Smith, & Oreovicz, 2002). This will help them to engage their learners in higher order thinking skills that are known to be essential for better learning outcomes.

For operating at these levels, the instructors need to be able to align the content (or curriculum), assessment, and instruction delivery (or pedagogy) for their regular

teaching-learning transactions (Stevler, Smith, & Pilotte, 2012). Biggs has coined the term ‘*Constructive Alignment*’ for such a process, and it enables the students to achieve higher cognitive levels in their learning practices (Biggs, 1996). Research cites that constructive alignment has been successfully employed by faculty in course redesign (Trigwell & Posser, 2014) and promotes deep learning among students (Wang, Su, Cheung, Wong, & Kwong, 2013).

Table 2.1: Levels of Inquiry in Engineering Education (adapted from Strevler et.al., 2012)

Level 0	Normal Teaching	Teach as Taught, without reflection
Level 1	Effective Teaching	Teach using accepted practices
Level 2	Scholarly Teaching	Assess teaching and make improvements
Level 3	Scholarship of Teaching and Learning	Engages in educational experimentation, shares results
Level 4	Engineering Education Research	Conducts Educational Research, publishes in archival journals.

2.3 Challenges in teacher technology integration in engineering education

The proliferation of information and communication technologies (ICT) has led to its widespread use in classrooms around the world in the last two decades. While the actual use of ICT in education has increased (Greenhow, Robelia, & Hughes, 2009), a number of challenges related to ICT supported constructivist teaching have been reported across different levels of education. Ertmer (1999) had provided an initial classification, as 1st and 2nd order barriers, on the basis of whether they are external or internal to the instructor. The first order barriers have been broadened (Hew & Brush, 2007) to external barriers like access to resources (Zhao, Pugh, Sheldon, & Byers, 2002), time for learning to use technology (Lim & Khine, 2006), subject culture (Hennessy, Ruthven, & Brindley, 2005) and institutional barriers (Fox & Henri, 2005). The 2nd order barriers consist of instructor pedagogical beliefs (Ertmer, 2005; Williams, Coles, Wilson, Richardson, & Tuson, 2000) and knowledge and skills of the instructor (Windschitl & Sahl, 2002). Tsai and Chai (2012) have expanded these knowledge and skills and added a 3rd order that dealt specifically with the design skills of the instructor based on their classroom practices and which comes one more level deeper than instructor’s skills on technology.

To explain the barriers in more detail, let us consider the scenario where an educational institution (without any ICT resources) located in a remote location with geographically difficult terrain for access. Thus the instructors from this institution have the first order barrier of access to ICT. Let us assume that to tackle this barrier the government/funding agency provides a set of computers through a helicopter or similar transportation means. Let us also assume that the instructors in this institute, who are used to practices like chalk and talk, are not familiar with usage of computers. These computer resources provided by the government/funding agency will be unfamiliar to these instructors and many will be skeptical of its utility as they have never explored the affordances of these resources before. This will limit the actual use of these resources by these instructors. This is the second order barrier related to use of ICT by an instructor. If the government and funding agency provide training and manpower to create belief and change attitude among the instructors, they still will have issues using this in classroom, as they need to design for effective use of these ICT resources within each of their classrooms. This is the third order barrier related to actual lesson design.

With the proliferation of technology, government and institutions have been taking adequate measures to reduce the issue of access to technology (Ertmer et. al, 2012; NMEICT, 2013). Thus there is a slow but steady improvement in the status of first order barriers, which has shifted the focus on to the second and third order barriers. To address this, a recommendation that has been made is to include ICT integration in pre-service teacher education programs (Lim, Chai, & Churchill, 2011) and TPDPs (Lawless & Pellegrino, 2007) of in-service teachers. Most of these efforts are for pre- or in-service teachers at the school level, but there are fewer systemic efforts at the college and university level (Schaefer & Utschig, 2008). At the tertiary education level, decisions for ICT integration is often left to the individual instructors (Shaffer, Akbar, Alon, Stewart & Edwards, 2011), leading to problems such as ineffective use of the tool (Selwyn, 2007), isolation and inability of individuals to find know-how (Conole et. al., 2004), and lack of percolation of good practices (Ebert-May et.al., 2011). Lack of pre-service training and rapid advancements in technology compound this problem even further.

The professional development efforts for technology integration in higher education mainly focus on the teaching of the skills of handling tools (Friedman & Kajder, 2006) and do not provide instructors with the necessary skills to successfully integrate technology (Mishra, Koehler, & Kereluik, 2009). Many of the later efforts emphasize the integration of ICT with constructivist pedagogical practices (Jonassen et.al., 2008; Kozma & Vota, 2014), especially in the Indian context (Banerjee, Murthy, & Iyer, 2015), leading to a constructively aligned teaching-learning interaction. Thus a main challenge for developing teacher technology integration training programme in engineering education is to train the current set of instructors in constructivist alignment practices.

2.4 Teacher Professional Development

Teacher Professional Development (TPD) is an umbrella term used for explaining the processes and programmes taken up to improve the teaching-learning practices in general. These efforts develop an instructor by focusing on the intellectual, motivational, procedural and productive elements within a teacher's practice (Evans, 2002). The common types of TPD activities include in-service teacher training, online training (as workshops and courses), peer mentoring, collaborative course design (Herman, 2012), seminars, conferences, open access portals, action research (Emerson & Mosteller, 2000) and setting up of professional learning communities (Vescio, Ross, & Adams, 2008).

2.4.1 Theory of TPD

The literature review for existing in-service teacher training was done primarily examining prominent ideas and models available for improvement in teaching learning practice, as well as examining various training programmes targeting similar goals as ours.

Key ideas and associated models for TPD

Some of the key ideas and associated models with professional development are provided below:

- **Reflective Practice:** The models following reflective practice ensure that there are activities for deliberate reflection within the training cycle that help

the instructor to critically look at their own practice and take informed decisions (Avalos, 2011). These activities can be of different forms like storytelling (Breault, 2010), use of teaching/school portfolios (Runhaar, Sanders, & Yang, 2010) or may even be assisting or supervising in the process of reflection (Joyce, 2014). Various models of reflective practice also exist that provide guidelines on operationalization of this reflection. Gibbs reflective cycle model (Gibbs, 1988) provides guidelines on developing a structured sequence of action and reflection while the Reflective practitioner model (Schoen, 1987) proposes use of coaching or mentorship by an expert practitioner (or master teacher) to develop reflection-in-action to improve professional practice.

- **Professional Collaboration:** The idea of professional collaboration looks at mechanisms and process to allow instructors to collaborate and learn from each other. These collaborations can happen at three levels – Community, parent Institutions and Peers. Communities of Practice model (Wenger, 1998) highlight the key ideas of collaborative relationships, shared understanding and communal resources that exist within the community (Wenger, 1998). Technology has been utilized extensively to facilitate such collaborations either through use of a single tool like Blogs (Yang, 2009) or through bigger platforms like online communities (Tseng & Kuo, 2014; Schagler, Fusco & Schank, 2004). Professional Learning Communities (DuFour, 2004; Newmann et. al., 1996) promotes teacher collaborations within a school by creating a collaborative culture that focuses on improving student learning. Co-teaching (Murphy & Martin, 2015) is another model of professional collaboration where teachers plan, teach and evaluate lessons together. This provides them avenues for sharing and learning from each other. In all the three models, teacher reflection plays an important part in improving the collaboration.
- **Action Research:** Performing action research within ones own teaching-learning context is yet another key idea that enables the teacher to improve and/or refine their actions through a systematic process of inquiry (Mills, 2000). Action research models have been widely used in pre-service education (Rock & Levin, 2002; Zeichner, 1987), and can achieve varied purposes based on the type of implementation. If done at an individual level, engaging in

action research leads to reflective practitioners and if done at scale this will lead to communities of practice (Sagor, 2000). Action research extends reflective practice by allowing teachers to go beyond making improvements in individual practice by documenting the process and disseminating with a larger community by publishing it.

- Technology Pedagogy And Content Knowledge (TPACK):** The TPACK provides information on how an individual teacher’s pedagogy (PK), content (CK) and technology knowledge (TK) interact with one another to produce effective technology integration (Mishra & Koehler, 2009). TPDP designers have used the framework to implement training programmes across various levels (Reinties et. al., 2013; Harris & Hofer, 2009; Bull, Hammond and Frester, 2008). TPD literature identifies three common ways of developing TPACK (see fig 2.2) – PCK to TPACK, TPK to TPACK, PCK & TPACK simultaneously (Koehler et. al., 2014). The first pathway looks at introducing technology to a practicing instructor and building on their existing PCK. This is a common approach for in-service TPD, as it aims to build on teaching experience of the in-service instructor. Such an approach is found to improve instructors’ decisions around educational technology (Harris & Hofer, 2011) by allowing them to reflect on the selection of appropriate technology features that align with the learning activities in the content.

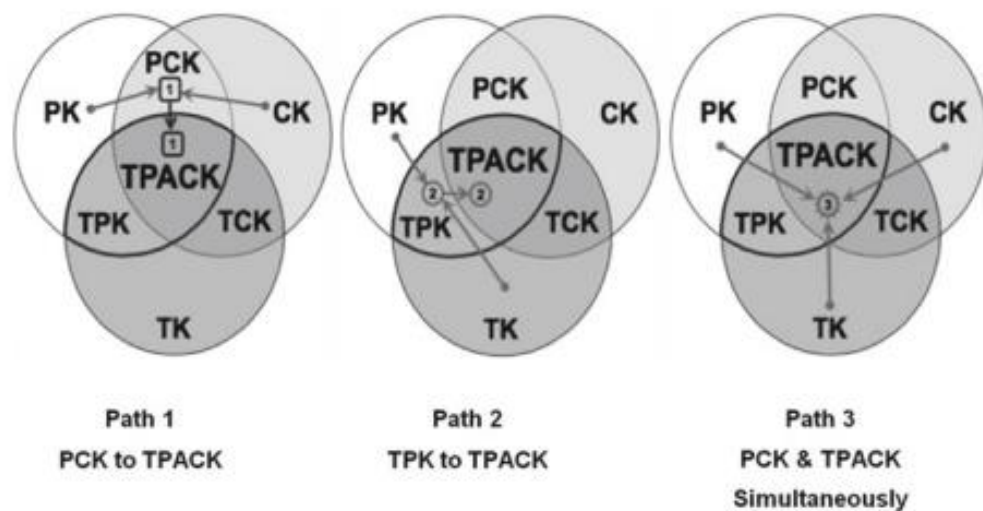

Figure 2.2: Three pathways to develop TPACK

To summarize, there exists various approaches and models for improving the technology integration practices of the teachers. However in all these, teacher

reflection becomes an important mediating factor that determines the effectiveness of the TPDP. Developing instructors' ability to perform action research will increase the sustainability of TPD benefits, however there is need for an active community of practice to both scale and sustain the efforts.

Recommendations and best practices for TPD

Research is abound with articles providing recommendations and best practices for increasing effectiveness in TPD (Avalos, 2011; Garet et. al, 2011; Desmione, 2009; Guskey & Yoon, 2009; Mouza, 2009; Birman et. al., 2001). These research points out the following characteristics that make TPD truly effective:

- Focus on instructors doing active learning within TPDP – Instructors should be engaged in active learning within a TPDP to ensure transfer of benefits to the students.
- TPDP should focus on implementation of research-based instructional practices – Participation in research-based instructional practices are shown to have brought sustained changes in instructors' belief towards teaching-learning with technology and ability to design and implement technology-supported learning experiences for students.
- Follow up for sustaining practices – Structured and sustained follow up after the initial TPDP effort is required to ensure just-in-time, job-embedded assistance while adopting new practices or curricula.
- Coherence with other learning activities – The TPDP efforts should be coherent with other academic activities as well as curriculum standards.
- Longer duration and effective use of it – Effective TPDP requires considerable duration and that time needs to be well organized, carefully structured, purposefully directed, and focused on content and pedagogy or both.
- Adaptation to the context – The TPDPs should be able to adapt the best practices to the specific content, process and context elements.
- Opportunity for collaboration – The TPDPs should provide sufficient opportunities for collaboration, both during and after, for the participating instructors.

2.4.2 Existing training programmes

The Course Design and Teaching Workshop at McGill University and National Effective Teaching Institute Program (NETI) at North Carolina University are two short-term training programs (STTP) that specifically target the constructive alignment (Biggs, 1996). The former workshop employs the design of alignment of learner outcomes, instructional strategies and evaluation to redesign an instructor's own course (Saroyan, et al., 2004). The content of this workshop include modules like concept mapping and active learning strategies to empower the faculty. The NETI workshops focus on learning styles, outcomes, research based instructional strategies and evaluation, and are organized in two stages – NETI I (basic) and NETI II (advanced) (Brent and Felder, 2009). Within the Indian context, it is seen that National Institute of Technical Teacher Training have developed a program for civil engineering instructors (NITTRC, 2013) targeting alignment.

The Course Design workshop at McGill comes closest to our requirement of an STTP focusing on alignment. However the workshop implementation looks at redesign of individual courses of participants during the STTP (Saroyan and Amundsen, 2004). This restricts its adaptation in our context, as most instructors are provided with prescribed curriculum by their universities. The NETI workshop process also have a minimum time gap of 6 months between the basic and advanced levels, rendering it difficult to adapt to the requirement of short-term training programmes.

For the goal of technology integration at university level, the Xanadu Project (Trentin, 2006) had proposed a two-level training programme for their open and distance learning, similar to NETI implementation. The first level training looked at basic skill acquisition in use of ICT and second level looked at advanced training aimed at deeper acquisition of methods required for effective use of ICT. The advanced training helped instructors in generation of e-contents and management of networked learning. The March^{ET} project (Reinties et. al., 2013) is a fully online TPD programme aimed at either individual or collaborative redesigning of participant instructors courses using technology tools of their choice. The project is primarily based on the theory of TPACK (Koehler & Mishra, 2005). This training engages teachers in 8-12 weeks of TPD, in line with the idea that changing of teaching practices requires time for instructors to reflect and implement in their own practice

(Lawless and Pellegrino, 2007). The participating instructors in March^{ET} are distributed into small groups during the training that permits flexibility of learning based on the convenience of participants.

The March^{ET} project comes closer to our requirement, however the programme may not be directly adaptable as working with participant selection of technology tool may not be feasible while scaling up the intervention. The issue of course redesign will also become problematic, as the course curriculum is not under the control of the participating instructors.

2.5 Evaluation of Training Effectiveness

TPD literature points to two key focus areas while examining training effectiveness – effect of training on teacher and effect on student learning (Avalos, 2011). The effect of TPD on instructors could be measured as learning during the training and the post training impact on instructors actual practice (Borko, 2004). The impact of TPD on the instructor could again be understood as changes in knowledge and skills and changes in attitude and beliefs that lead to changes in teaching practice, ultimately improving student learning (Desmione, 2009). Thus if we were to examine the outcomes of training the various measures that are available with us would be – Change within teacher learning, Change in teaching practice, Change within students, Institutional Impact (Stes et. al., 2010).

Most of the outcome studies build on Kirkpatrick's levels of evaluation (1996), which talk of four different levels – *reaction, learning, behaviour and results*, while examining training effectiveness. These levels are defined as:

- i. Reaction – To gather data on participant reactions at the end of a training program [L]
[SEP]
- ii. Learning – To assess whether the learning outcomes for the program are met.
- iii. Behaviour - To assess whether job performance changes as a result of training.
- iv. Results - To assess costs vs. benefits of training programs, i.e., organizational impact [L]
[SEP] in terms of reduced costs, improved quality of work, increased quantity of work, etc.

Existing research shows application of a host of methods to collect and assess the data related to training effectiveness across these levels. For instance, while gathering data related to instructors' beliefs and intentions, researchers have used pre-post test design by administering a Belief and Intention questionnaire along with TPACK measures to understand technology integration practices (Rienties, Brouwer and Lygo-baker, 2013). Gibbs and Coffey (2004) have also relied on pre-post design using Approaches to Teaching Inventory to identify the effect of TPD on teacher conceptions. McShannon and Hynes (2005) report on an extended training that uses quantitative methods to measure levels of learning and behaviour of engineering and science instructors. Qualitative data like classroom observations, lesson design analysis measured through evaluation rubrics

There is a strong critique among the research community on studies that rely primarily on reactions to measure training effectiveness, as reaction is considered as only an intervening variable towards the path for change (Stes et. al, 2010). This is a crucial input towards reduction of barriers related to attitude and beliefs about technology integration (Ertmer, 1999).

2.6 Sustainability

Sustainability is yet another metric of training effectiveness and has been identified as a central challenge for scaling up educational interventions (Coburn, 2003). The professional development literature contains various definitions of the term sustainability, with the most prominent ones being those related to long-term continuation of benefits even after termination of the program (DEZA, 2002). Hargreaves and Fink (2003) have extended this to include capacity of the educational environment to incorporate the change without any adverse impact to its surroundings. In an analytic review of 191 articles published between 1995-2008 on teacher professional development at K-12 level, Henderson, Beach and Finklestein (2011) had identified that the existing strategies of development and dissemination of best practices and top-down policy making were not making sustainable changes. The study also confirms the need for the coordinated and focused efforts by various stakeholders within the TPD activity to last for a longer time (Korthagen, Loughran & Russel, 2006) to make it sustainable. These coordinated efforts should span across the

dimensions of content (action and reflection by teacher), community (individual and social activities of the teacher) and context (internal and external support to the teacher) (Zehetmeir and Krainer, 2011).

2.7 Need for this thesis work

With ubiquitous use of ICT across different levels of education, effective technology integration by the instructor is becoming increasingly important. The significance of the effort increases for Indian higher education, specifically engineering education, as the various government reports have repeatedly highlighted the issue of both instructor and student quality (Pal, 1993; National Knowledge Commission, 2006). One of the possible strategies identified is increasing access of technology and providing TPDPs (NMEICT, 2009). However, technology integration by an instructor is a complex challenge that suffers from three levels of barriers (Ertmer, 1999; Tsai and Chai, 2012) – Access to technology, Attitude and beliefs towards technology and Lesson Design skill. Provision of ICT resource and access to large-scale training will only help in reducing the first barrier. To reduce the other two, instructors should be exposed to meaningful learning with ICT during the training itself (Desmione, 2009; Guskey, 2000). This would require instructors to be trained in constructive alignment practices that will allow them to use constructivist practices along with technology.

The exploration of existing training programmes shows a few that have similar goals (Saroyan and Amundsen, 2004; Trentin, 2012; Reinties et. al., 2013). The exploration of TPD models provided us with diverse best practices and recommendations, with no model available for scaling the training itself. However, none of them are directly adaptable to our context as the scale of implementation is considerably high. There are a total of 6430 engineering institutions across the country catering to nearly 30.9 lakh students but having only 5.78 lakh teachers (AICTE, 2016). Most of these institutions and government primarily rely on short-term training programmes (STTP) to improve the quality of their teachers. STTPs have been traditionally been critiqued by educational researchers for their inability to provide significant training benefits beyond programme tenure (Desmione, 2009; Korthagen, Loughran & Russel, 2006; Fullan, 2006). Thus the administrator or trainer operating in this space is confronted with three challenging problems:

- a. Training teachers in constructive alignment practices for effective technology integration
- b. Improve effectiveness of STTPs to extend beyond program tenure
- c. Scale the training to cater to larger audience

These problems provide two clear research goals :

- I. Development of a scalable model that will assist in implementation of TPD programme for technology integration.
- II. Implement and evaluate the effectiveness of the training programmes created from the model.

Chapter 3

Research Design

As already seen in Chapter 1, the broad problem statement that is being investigated in this thesis is: “How can we improve the design and delivery of training programmes to the in-service faculty in engineering education within India to enable them in effectively integrating Information and Communication Technology (ICT) tools within their teaching-learning context?” The review of literature presented in Chapter 2 provides us with two clear research goals:

- I. Development of a scalable model that will assist in implementation of TPD programme for technology integration.
- II. Implement and evaluate the effectiveness of the training programmes created from the model.

To address these goals there was a need to focus on working closely with practitioners (engineering college teachers), and training programme administrators (T10kT team) to:

- a) Identify the common technology integration practices within our operating context to understand the areas where the practitioners require support
- b) Design and develop modules of training that will provide required support in improving existing practices
- c) Implement and evaluate the training to identify the strategies and conditions under which the training becomes effective

- d) Reflect on the evaluations and develop a model that will assist in scaling the training design and implementation
- e) Use the model to scale the training in multiple modes by iterating steps ‘b’ to ‘d’

Each of these steps would require use of both quantitative and qualitative methods in an iterative fashion, with primary focus on solving a problem of practice. Two research methodologies support incorporating both quantitative and qualitative data in analysis – Multi-phase Mixed-methods Research (MMR) and Educational Design Research (EDR). MMR methodology is “an approach to inquiry involving collecting both quantitative and qualitative data across multiple longitudinal studies, integrating two forms of data, and using distinct designs that may involve philosophical assumptions and theoretical frameworks with a common focus for the multiple studies” (Creswell, 2013). As seen in fig 3.1, MMR allows use of quantitative (QUAN), qualitative (QUAL) or mixed (MM) methods in a sequential manner across multiple iterations to satisfy the larger programme objective, which in this case is improving technology integration practices. However, such an MMR design will not factor the participation of practitioners in the design of the solution (steps ‘a’, ‘b’ and ‘d’) and scaling of intervention (step ‘e’) that is crucial in our context. Educational Design Research (EDR) methodologies, that caters to both solving problems of practice and generation of theories (or design principles) (Plomp, 2013), becomes an ideal candidate methodology for this research.

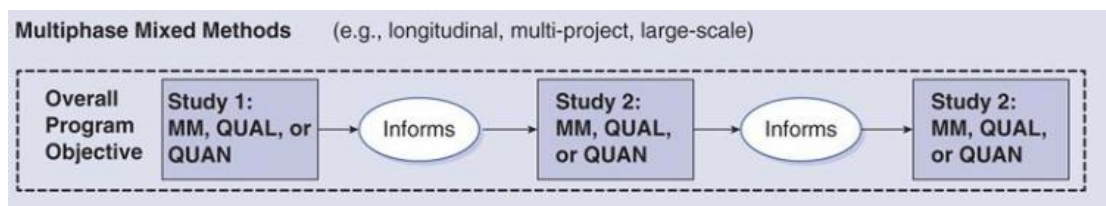

Figure 3.1: Overview of Multi-phase Mixed-methods Research (MMR)

In this chapter I first describe the characteristics of EDR methodologies that make it a suitable methodology in our context (Section 3.1.1) and characteristics of DBIR that make it an ideal choice within available EDR methodologies (Section 3.1.2). I then describe the flow of research in this thesis (Section 3.2), specifically describing the execution of exploratory studies (section 3.2.3) and methodology involved in DBIR iterations (section 3.2.3). I then provide a brief description of the nature of research-

practice partnership formed and explain how the principles within DBIR are implemented in the current thesis (section 3.3). This is followed by the broad research questions answered (section 3.3) across the multiple iterations and the data collection and analysis procedures (section 3.4).

3.1 Choosing an appropriate EDR methodology

3.1.1 Need for Educational Design Research (EDR) methodology

Broadly EDR is: “a series of approaches, with intent of producing new theories, artefacts, and practices that account for and potentially impact learning and teaching in naturalistic settings” (Barab & Squire, 2004). The focus on development within “naturalistic settings” ensures that there is an active involvement of practitioners throughout the design research cycle. A lot of similarities can be drawn with participatory action research while considering the characteristics of working on problems of practice and inclusion of practitioners in the solution building. However, the additional intent on generating theories (related to implementation) sets EDR apart from participatory action research methodology (Plomp, 2013). The following are the additional characteristics of an EDR based study (Van den Akker et. al., 2006):

- Iterative nature that involves cycles of analysis, design and development and evaluation
- Process oriented focus that necessitates use of both qualitative and quantitative methods to better understand the intervention
- Contextualized design

Three common approaches within EDR are Designed Based Research (DBR), Design and Development Research (DDR) and Design Based Implementation Research (DBIR) (Kopcha, Schmidt, & McKenney, 2015). DDR methodology focuses on development of effective interventions to solve educational problems generating contextually sensitive design principles and theories (Wang & Hannafin, 2005). DBR methodology too can be useful in this process of development of interventions and design principles, however it additionally provides flexibility to explore and validate theories related to learning in the operating context of the intervention (Anderson & Shattuck, 2012). DBIR methodology focuses on the implementation and scaling up of

interventions and generating design principles related to strategies and conditions under which these implementations happen (Penuel et. al., 2011).

Thus if I consider the complete life cycle of educational intervention, starting from planning of the intervention to scaling up implementation of intervention, I can identify three broad categories of studies that can be make use of EDR methodology – Development study, Validation study and Implementation study. The research goals and outputs of each of these studies vary, and this is shown in Table 3.1 (see next page). The table also provides information on the EDR methodologies suitable while doing each of these studies.

As seen from Table 3.1, among the three types of studies, only the Design Based Implementation Research (DBIR) has an explicit focus on large-scale implementation. Thus I have shortlisted DBIR as the appropriate research methodology for our current research.

Table 3.1: Types of EDR Studies and their Outputs (adapted from (Plomp,2013))

Type of Study	Research Goal	Output of Research	Type of EDR
Development Study	Development of Intervention	Developing a research based intervention as a solution to complex problem	DDR, DBR
		Constructing (re-usable) design principles	
Validation Study	Theory Development and/or validation	Designing learning environments with the purpose	DBR
		Develop and validate theories about learning, learning environments or to validate design principles	
Implementation Study	Implementation and Up-scaling	Implementing a particular program	DBIR
		Strategy and conditions under which implementation can happen (design principles)	

3.1.2 Why DBIR is an appropriate research methodology?

The DBIR philosophy belongs to the broader umbrella of Educational Design Research methods that operate within the intersection of research and practice and helps in bringing interventions to scale (Fishman et. al., 2013). The core principles that characterizes DBIR are (Penuel et. al., 2011):

- I. Focus on Persistent problems of practice from multiple stakeholders' perspectives
- II. A commitment to iterative, collaborative design
- III. A concern with developing theory and knowledge related to both classroom learning and implementation through systematic inquiry
- IV. A concern with developing capacity for sustaining change in systems.

Based on the review of challenges in technology integration in engineering education (Section 2.3) and the unique operating context of a project related to implementation of large-scale training program (section 2.1), the solution requires a research methodology that will help in the large-scale implementation without compromising on the requirements of various stakeholders involved. I have identified the following characteristics about the intended solution that aligns with the principles of DBIR.

- The specific problem of practice addressed is that of "improving effectiveness of using technology in classrooms (Principle I)
- With the operating context of training programmes as part of T10kT, the perspectives of multiple stakeholders (T10kT project administrators, participating institutions and participating teachers), apart from researchers, have to be factored in to the solution. (Principle II).
- Generate theories and/or design principles that will be useful for future large-scale TPD efforts within the Indian context. (Principle III)
- The solution of improving training program design and implementation is expected to have a direct impact on the capacity of large number of teachers within each institution participating in the T10kT project. Thus there is an explicit focus on improving the capacity of the system (Engg. Education) as a whole - (Principle IV)

The implementation of these principles in our research is detailed in section 3.2.3. DBIR approach is found ideal for exploratory, design and development, efficacy, and effectiveness or scale-up studies as shown in Table 3.2 (Penuel, 2015). The table shows potential research questions and useful methods or data that is useful in answering these research questions. They serve as ideal starting points to start out a DBIR project, and provide insights on possible trajectories of research and development. Thus if it is an early-stage research and development project, DBIR

provides useful information on exploratory, design and development studies possible within it. On the other hand if it is a late-stage research and development activity, DBIR provides insights on the type of efficacy and effectiveness and scale-up studies.

Table 3.2: DBIR Questions and methods mapped against phase of research (Penuel, 2015)

Phase of Research	Potential Research Questions	Potentially Useful Methods / Data
Exploratory: Negotiating the Focal Problem of Practice	What problem of practice should be the focus of our joint work?	Analyses of available data from multiple sectors ^[1] Research evidence related to domain learning Perspectives and values of stakeholders (including non-school actors) ^[1] Improvement science methods: Root Cause Analysis ^[1] and Change Laboratories
Design and development: Co-design	What should be the focus of our work? ^[1] To what extent do teams leverage the diverse expertise of stakeholders? What co-designed tools might help address the shared problem of practice?	Documentation of design rationales Participatory design routines Ethnographic analyses of the co- design work
Design and development: Early implementation research	How do implementers adapt the innovation to their local contexts? How do implementers use the innovation to reconstruct their practice? What are the appropriate measures of impact from early cycles of improvement?	Observations and analysis of implementation ^[1] Interviews ^[1] Practitioner documentation of enactment Principled assessment design (e.g., evidence-centered design, construct modeling)
Efficacy	What is the potential impact of the innovation on teaching and learning? What mediates impacts on learning?	Randomized Controlled Trials Interrupted Time Series Designs Explanatory Case Studies
Effectiveness and Scale Up	What supports are needed to implement the program effectively across a system? ^[1] What are the conditions for sustainability?	Experimental comparisons of different means of support Explanatory comparative case analysis

In the current context I require all these research phases, albeit in varying focus, to come up with a model for technology integration training that can be scaled further.

3.2 Implementation of DBIR in our context

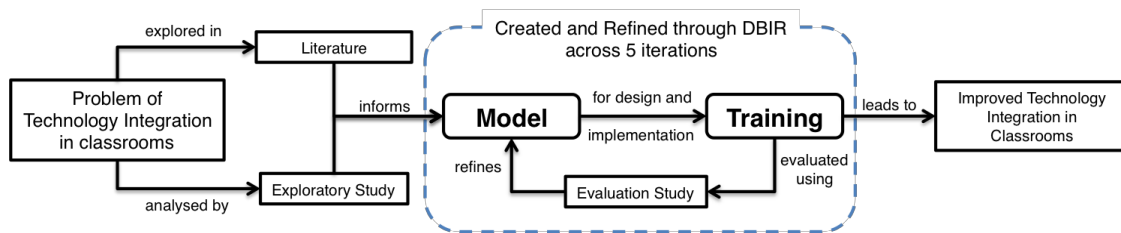

Figure 3.2: Flow of research in this thesis for solving the problem of practice through DBIR

Figure 3.2 shows the flow of research undertaken in this thesis to solve the problems of practice related to technology integration in classroom. Based on analysis of existing literature and initial exploratory studies we have developed the Attain-Align-Integrate-Investigate (A2I2) model for designing large-scale training programmes (detailed in Chapter 5). The model is used to design and implement training programmes for teachers, which is then evaluated to identify refinements needed in the model. The entire design-implement-evaluate-refine cycle is iterated five times across three different modes to scale the training. This cycle forms the core of DBIR methodology adopted in this thesis and provides feedback to both researchers and practitioners. Practitioners use this feedback to improve their current practice while researchers use this feedback to improve the theoretical understanding of either the problem or the intervention and thereby refining the model.

3.2.1 Need for Exploratory Phase

An important input to the design of the model is the existing conceptions about effective technology integration practices, i.e. use of active learning strategies with technology, within our operating context of Indian engineering education. Educational research points out the need for use of student-centered strategies for effectively integrating technology (Howland et. al., 2012) and the three levels of barriers that doesn't permit teachers to integrate technology (Ertmer, 1999; Tsai and Chai, 2012). The presence of initiatives like T10kT project have reduced the barrier related to access to technology in our operating context. However there is still scant information on the technology integration practices of teachers and their conceptions on effective technology integration within the operating context. The levels of inquiry within engineering education, discussed in section 2.2, recommends instructors to continuously assess their own practice and make improvements (Strevler et. al., 2012)

to sustain the best practices. This would require instructors to reflect on their own practice and develop an inquiry stance towards it. Thus there is a need to also evaluate the ability of Indian instructors to reflect on their practice so as to sustain effective technology integration practices. This necessitates the need for exploratory research studies to answer:

1. What is the perception of instructors, in Indian engineering education, towards active learning strategies?
2. How effective are the instructors in reflecting on their own technology integration practice?

Two exploratory studies were conducted (see Chapter 4) to answer these questions. The results from these studies inform the initial version of the model that is used for the design and implementation of the first training.

3.2.2 Research flow within DBIR phase

The flow of a single iteration within DBIR methodology in this thesis is shown in the figure 3.3 (next page).

The training designed from the A2I2 model gets implemented in a space where there is a research-practice partnership (RPP). The researchers will evaluate the training and identify the conditions and strategies that worked in this training implementation. This knowledge will be used to refine the A2I2 model. The instructors (practitioners) attending the training will use the training to take up the improved technology integration practices.

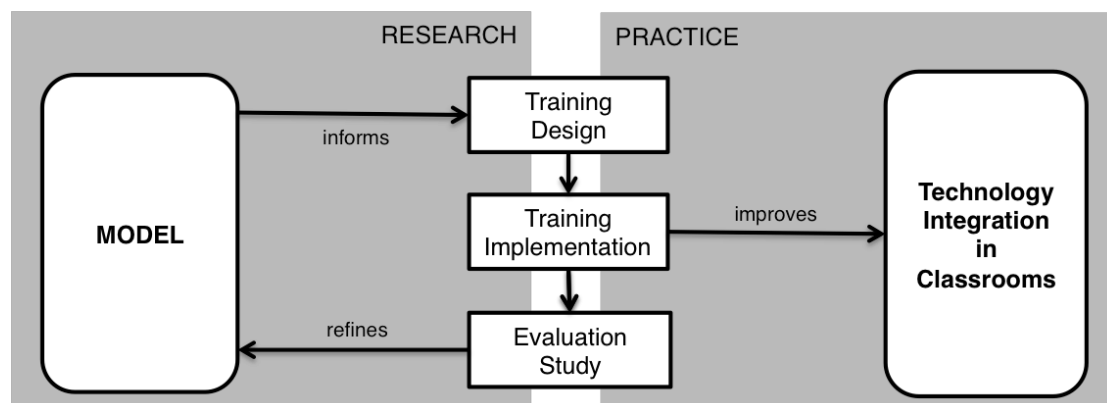

Figure 3.3: Single Iteration within DBIR

The model gets refined through five iterations of implementation and evaluation across 3 different modes of implementation to achieve scalability (see

Table 3.3 below). The entire longitudinal project with five iterations is called as “Educational Technology for Engineering Teachers” (ET4ET), and the numbering of iteration was from ET4ET₀ to ET4ET₄. The first iteration, termed as ET4ET₀ as it was a pilot implementation, was in face-to-face mode with 23 participants. The technology focused in this training was ‘Visualizations’ (video/animation/simulation etc). The next two iterations (ET4ET₁ and ET4ET₂) were done in a blended online environment that consists of synchronous online classrooms and asynchronous offline activities with focus on technologies of ‘Visualizations’, ‘Wiki’ and ‘Screencast’. The scale is also increased to reach 4358 participants by ET4ET₃. The fourth iteration was done in a blended mode, but had select participants from ET4ET₂ and ET4ET₃, with asynchronous online and face-to-face sessions focusing on sustaining the effort. The new technology that was introduced in this iteration was ‘Padlet’.

Table 3.3: Overview of implementation mode, scale and technologies trained within the DBIR

	Iteration 1 (ET4ET ₀)	Iteration 2 (ET4ET ₁)	Iteration 3 (ET4ET ₂)	Iteration 4 (ET4ET ₃)	Iteration 5 (ET4ET ₄)
Started	Jun, 2013	Jun, 2014	Jan, 2015	Jun, 2015	Jan, 2016
Mode	Face-to-Face	Blended Online			Massive Open Online
Number of Participants	23	1300	4358	51	5105
Scale	1x	~56x	~189x	~2x	~221x
Technologies Trained	Visualization	Visualization, Wiki, Screencast	Visualization, Wiki, Screencast	Padlet	Visualization
Impact on Model	A2I created	A2I refined and scaled	A2I2 created	A2I2 refined	A2I scaled

The final iteration is developed as a massive open online course, with only asynchronous interactions, and had 5105 participants. Once again we focused only on the technology of ‘Visualizations’ in this mode.

3.2.3 Research-Practice Partnerships in our context

The research-practice partnership (RPP) developed within an EDR differentiates these research studies from the regular mixed-method research designs. The traditional definitions of partnership vary from consulting relationships to more close knit

university-school partnerships (Coburn, Penuel, & Geil, 2013). Based on the sharing of responsibilities, these partnerships can range from co-operative to collaborative.

A cooperative RPP is one in which the roles of researchers and practitioners are clearly distinct with collaborations occurring for short time spans. E.g. Research alliances between university researchers and schools focussed on evaluating implementation of educational policies can be considered as a cooperative RPP. Here the researchers interact with the school at the start of the research to negotiate the focus of the activities and then towards the end to discuss the findings. The researchers distance themselves from the practitioners at the time of research to maintain objectivity of the research findings. A collaborative RPP on the other hand emphasizes on co-design and engage both researchers and practitioners in the process of designing, developing and testing innovations. E.g. consider the co-design done by a team of teachers and researchers in designing strategies for improvement of classroom learning. Here right from the inception of the partnership, teachers and researchers share their knowledge about classroom practices and theories of learning to either come up with a new strategy or refine an existing strategy. Once the implementation is done, they work together to publish their findings so that other researchers and practitioners can make the best use of the results and insights.

Figure 3.4 shows the continuum of research-practice partnership, with the red triangular area highlighting the sharing of responsibilities happening within the partnership.

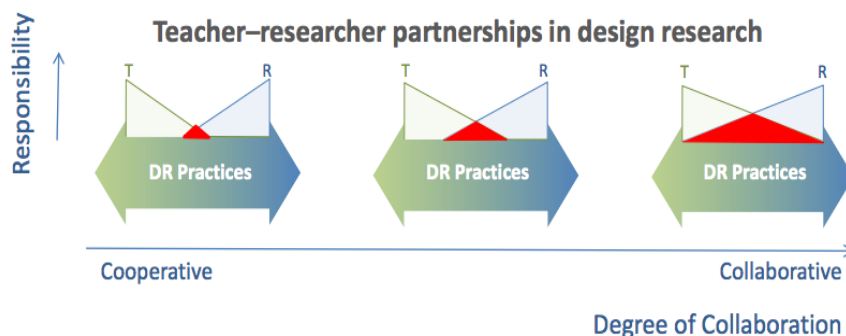

Figure 3.4: Research-Practice Partnerships in Design Research (Kali, 2016)

Thus as one moves from cooperative to collaborative, there is a corresponding increase in the responsibility for both. For the current research I have considered the definition of partnership as the association made by the researchers with the

practitioners involved in the TPDP. Within the current research there is a gradual transition of the partnership from cooperative, at the start of the programme, towards collaborative practices at the end of the programme. Further details about the RPP are detailed in chapters 6, 7 and 8 where the DBIR iterations are provided in detail.

3.2.4 Application of DBIR Principles in our context

In the current context of research, to solve the problem of technology integration in classrooms we have proposed the solution of developing a model for design and implementation of training programmes that can be scaled. This model is then used to design five training programmes in three different modes (face-to-face, blended online and massive open online) using the established structures of continuing education programme and T10kT project.

Principle I: Focus on persistent problems of practice from stakeholders' perspective

The stakeholders within our current research study are: college instructors, college administrators, training programme administrators, training programme designers and researchers, trying to tackle the problem technology integration within the classroom. Here the researchers also have the twin role of training programme designer. Such a partnership brings in diverse views about aspects related training needs (i.e. chosen technology), available resources, training evaluation mechanisms etc. that is inherently related to the main problem of technology integration in classrooms. The major training needs have been identified through: (a) Review of literature on existing problems of instructor quality in Indian Engineering Education, (b) Review of objectives and modus operandi of T10kT programme that involves voluntary acceptance by college administration, (c) Discussion with T10kT administrative team right from program design to certificate dispatch, and (d) Exploratory studies conducted in the operating context (Refer to Chapter 4 for more details).

Principle II: Teams commit to iterative, collaborative design to improve practice.

Through the T10kT project, a system has already been established to ensure partnership with the practitioners. Each training programme in T10kT is facilitated through a remote center coordinator from the participating institution, and thus ensures a mechanism to provide inputs from participating teachers. By

contextualizing our research within the T10kT project, we ensure that a research-practice partnership exists during the problem resolution. Additionally, by conducting five training iterations, we ensure that participants' feedback get factored in the solution design. The nature of the research-practice partnership is detailed in the next section (3.2.3).

Principle III: Teams develop theory and knowledge related to both classroom learning and implementation through systematic inquiry

The need for scaling the training programmes necessitates that our research produce design principles that will help in design and implementation of future programmes done at scale. These trainings primarily inform practice by providing research-based strategies for classroom learning and are also expected to inform researchers about the conditions and strategies that facilitate achievement of the training benefits. The survey of classroom practice has been done in detail at the end of iteration 3 and the changes in classroom practice analysed through a thematic analysis (Section 7.3.3) of participant response to a survey question.

Principle IV: DBIR is concerned with developing capacity for sustaining change in systems

Sustainability is a major driver within the design goal of the professional development program. Some of the possible mechanisms tried out within our current research to promote sustainability are mentorship for teachers to conduct educational research within own settings, rewards in terms of certificates, creation of content repositories, and invitations for collaboration etc. The exploratory study 2 (section 4.2) provided initial data on the mentorship practices and the various actions taken by mentee instructors towards sustainability of own practice through classroom action research. The feedback survey, collected after training iteration, further provided preliminary understanding of sustainability of training benefits within each instructor's operating context.

3.3 Research Questions

The twin research goals, as identified from literature review, can be categorized as Design and Development Goal and Evaluation Goal. These are:

- I. Design and Development Goal - Development of a scalable model that will assist in implementation of TPD programme for technology integration.
- II. Evaluation Goal - Implement and evaluate the effectiveness of the training programmes created from the model.

While the latter goal clearly focuses on efficacy of the implementation, the former focuses on design and development as well as effectiveness and scale-up, discussed in Table 3.2. Thus the research questions need to capture the variables affecting these goals to provide us information on: (i) Effectiveness of the implementation and (ii) Strategies and conditions under which the implementation and scaling is found to be effective. Thus the following broad evaluation questions (EQ) emerge:

- EQI. What are the persistence rates when the training is scaled using A2I2 model?
- EQII. What is the perception of participants' at the end of training designed based on A2I2 model?
- EQIII. What is the learning of participants' at end of training designed based on A2I2 model?
- EQIV. What is the post-training behaviour of participants who attended the training designed based on A2I2?
- EQV. How sustainable are the training benefits?

The first three evaluation questions correspond to the first three levels of training outcomes specified in Kirkpatrick's model for training evaluation - *reaction*, *learning* and *behaviour* levels (Kirkpatrick, 1998). The final two questions correspond to the effectiveness of strategies and conditions for implementation and scaling. There are also preliminary evidences of transfer of training benefits impacting the teaching-learning ecosystem (*results* level in Kirkpatrick's model), where a few participating teachers have proceeded to conduct educational research and its dissemination.

Table 3.4 shows the levels of evaluation associated with each of the training iteration within the DBIR methodology. Starting from a pilot implementation (ET4ET₀) in face-to-face mode, there are a total of five iterations in this thesis. Each iteration had one corresponding evaluation study (Study 1 – Study 5) with 2 or more research questions related to the broad research question. These research questions are labelled based on the research study that it corresponds and the focus of the evaluation metric

(Persistence, Perception, Learning, Sustainability and Behaviour, in that order). For instance, in the pilot study (Study 1, ET4ET₀), the focus was only perception and learning. Hence the research questions for perception is labelled as RQ 1.1 and that for learning is labelled as 1.2. While moving to second iteration (Study 2, ET4ET₁), the research questions related to persistence will be RQ 2.1, and the ones related to perceptions will be RQ 2.2.

Table 3.4: Metrics being evaluated within this DBIR iterations and corresponding RQs

Iteration (Training)		Iteration 1 (ET4ET ₀)	Iteration 2 (ET4ET ₁)	Iteration 3 (ET4ET ₂)	Iteration 4 (ET4ET ₃)	Iteration 5 (ET4ET ₄)
Mode		Face-to-Face	Blended Online			Massive Open Online
Number of Participants		23	1138	4358	51	5105
Research Study		Study 1	Study 2	Study 3	Study 4	Study 5
Evaluation	I. Persistence	-	RQ 2.1	RQ 3.1, 3.2	-	RQ 5.1
	II. Perception	RQ 1.1	RQ 2.2, 2.3	RQ 3.3	-	RQ 5.2
	III. Learning	RQ 1.2	-	RQ 3.4	-	-
	IV. Behaviour	-	-	RQ 3.7	-	-
	V. Sustainability	-	-	RQ 3.5, 3.6	RQ 4.1	-

3.4 Data Collection, Analysis and Ethical Considerations

DBIR methodology helps in answering questions related to effectiveness of the training strategies and the adaptations required while scaling for these strategies to work under wide range of conditions (Fishman et. al., 2013). Hence the methods chosen across iterations within DBIR are required to provide sufficient flexibility to use both quantitative and qualitative data for better answering the five broad research questions. The data will be related to participants' interaction with the training content, training environment (both collected during training) and actual practice (collected after the training). Among these, the data collected for answering research questions 1, 2 and 4 relate to the evaluation levels of *reaction*, *learning* (Kirkpatrick, 1998) and *persistence*, respectively, and is obtained during the training itself. The data collected for research questions 3 and 5 relate to the *behaviour* level (Kirkpatrick, 1998) and *sustainability*, respectively, and is collected after the training.

Table 3.5 shows the various metrics of evaluations, the data source or instruments used for answering each research question in each of the iteration. The table also provides forward reference to the relevant section in this thesis where these instruments are detailed. The perception data has been collected through survey questionnaires. The end of training survey for evaluating participant perception has been created and validated by the research team while the technology competence survey has been adapted from a standard instrument (Milman, Kortecamp & Peters, 2007). The learning has been evaluated by assessing the lesson plans submitted by participants. A validated rubric for technology integration was used for assessing the submitted lesson plans. More details about the rubric are available in the Sections 6.3 and 7.2, where the study is detailed.

Table 3.5: Data Sources / Instruments used in our DBIR methodology

	Data Source/Instruments in each iteration				
	Iteration 1 (ET4ET ₀)	Iteration 2 (ET4ET ₁)	Iteration 3 (ET4ET ₂)	Iteration 4 (ET4ET ₃)	Iteration 5 (ET4ET ₄)
Perception	End of Training Survey Focus Group Discussion	Technology Competence Survey (at end) End of Training Survey	Technology Competence Survey (at start and end) End of Training Survey		End of Course Survey
Learning	Lesson Plans		Lesson Plans		
Behaviour			End of Semester Survey		
Participation		Assignment Submissions	Assignment Submissions		IITBombayX activity details
Sustainability			Open Ended Response analysis	Wiki submissions, Focus Group Discussion	
Detailed in	Section 6.3	Section 7.2	Section 7.3.	Section 7.4.	Section 8.3

The participation data was obtained from the logs within the learning environment used for scaling the training. To collect the behaviour data, an online survey was administered to the participants after a minimum of one semester (3-4 months) of completion of training. Apart from questions on the usage of resources provided during the training, the survey had an open-ended question regarding the changes that

was felt by the participants in their own practice. Thematic analysis (Braun and Clarke, 2006) was used to analyse the responses to identify the medium-term sustainability shown by the participants. More results on medium-term sustainability were obtained by the content analysis of wiki submissions during Iteration 4 (ET4ET₃).

In each of these iterations, participants were informed of the research focus at the start and informed consent was obtained during the data collection. While administering the online surveys, there was a separate question that provided them the option to mark their consent. It was stressed that none of the identifying features like respondent name, their institution or even their student name will be revealed while reporting the result. For focus group discussions and open-ended responses, specific consent was obtained for quoting the participants. Data storage policies regarding the collected artefacts and interview recordings have also been implemented by saving the data in a machine that is not connected to the network. The current data storage policy is to store the data for 5 years, after which the research group will take fresh permission to continue storage of data.

In the next chapter I describe the initial exploratory studies and their results that helped us to create the initial model and further refine the training goals.

Chapter 4

Exploratory Phase

In the previous chapter I had identified two exploratory questions within the operating context that need to be answered prior to design and development of the model. These are:

1. What is the perception of instructors, in Indian engineering education, towards active learning strategies?
2. How effective are the instructors in reflecting on their own technology integration practice?

Answering these questions will help in refining the training goal and thereby provide valuable inputs towards design of the solution. Two exploratory studies, within T10kT programme in blended online mode, were undertaken to answer these queries (see Table 4.1 below).

Table 4.1: Overview of the training programmes in the exploratory phase

Study	Training Goal	Mode and Duration of training	Number of participants
Study 1	Expose computer science teachers teaching undergraduates to use of active learning strategies while integrating technology during teaching-learning of programming	Synchronous: 3 hours	7633
Study 2	Familiarize engineering college teachers with research methods in performing classroom action research while integrating technology	Synchronous: 12 hours Asynchronous: 12 hours	5675

As seen from the table, both the training programmes were for short duration. In the first training, which was for 3 hours duration, the focus was only on training instructors in effective integration of technology using active learning strategies. In the second training programme, blended the training was utilized by keeping one week of asynchronous session immediately after a day of synchronous activity. The overall training was equivalent of 24 hours of TPD, split across synchronous and asynchronous modes equally. In the sections 4.1 and 4.2, we detail the exploratory studies conducted during these training. The implications of the results obtained in these studies are detailed in section 4.3, which subsequently helps in refining the training goals that is detailed in section 4.4.

4.1 Exploratory Study 1

4.1.1 Overview of the Training Programme

This training programme was done as part of T10KT project in a blended format for computer science teachers and focused on effective teaching learning of computer science programming. The training consisted of two sessions of 1.5 hours duration covering content, pedagogy (active learning) and the technology involved in the teaching-learning computer science programming at undergraduate level. The goal of the training was to expose participants to active learning strategies while integrating technology to make the learning with ICT more meaningful (Howland et. al, 2012).

The active learning strategies focused during the training were Peer Instruction and Think-Pair-Share, while the technology being focused were computer based visualizations, like animations and simulations that were common in our operating context. 7633 teachers, teaching undergraduate computer science subjects, from 130 remote centers had registered for this workshop. The training environment consisted of A-VIEW for facilitating synchronous interactions (conferencing with ability to synchronous chat) and MOODLE to facilitate asynchronous interactions (course resource sharing, administering surveys, discussion forum etc.). Fig 4.1 shows the configuration of the training environment having both synchronous and asynchronous interactions.

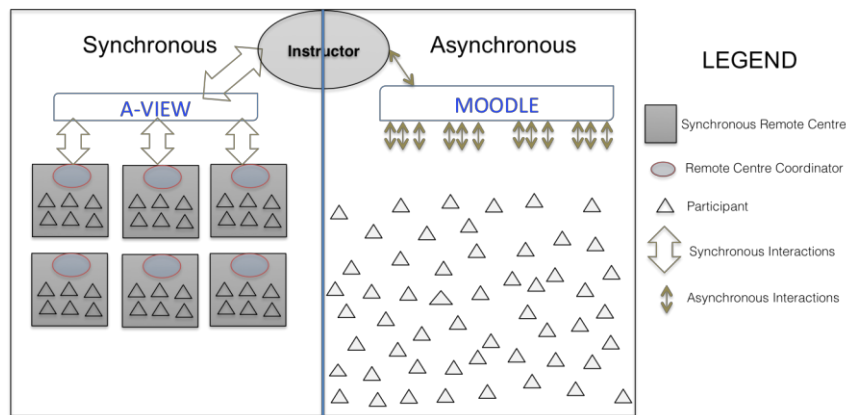

Figure 4.1: Training environment facilitating blended mode of instruction in T10kT programmes

4.1.2 Research Design

Effective ICT integration requires instructors to use ICT as a mediation tool to engage students in activities that require higher order thinking skills. In this study we focus on instructors' perception of usefulness of active learning while teaching with ICT and instructors understanding of active learning. Computer-based visualization was chosen as the ICT tool, because it is one of the frequently used ICT tool by teachers in our context.

Computer-based visualizations are “the use of computer supported, interactive, visual representations of data to amplify cognition” (Torry and Moller, 2004), such as, educational animations and simulations. These visualizations have been shown to improve conceptual and procedural understanding, develop reasoning and prediction skills and aid in construction of mental models (Rutten, van Joolingen and van der Veen, 2012).

Research Questions

- i. What are instructors' perceptions of usefulness and need for support in active learning and ICT integration?
- ii. What are instructors' understandings about meaning of active learning?

Sample

The sample consisted of 3688 computer science instructors, teaching undergraduate courses in engineering colleges, from across India. These teachers had teaching experience ranging from less than a year to over 10 years.

Instrument used

The study consisted of a quantitative large-scale survey with computer science instructors to record instructor perception of usefulness and need for support in implementing active learning with ICT. This survey also had an open-ended question to probe instructor conception about active learning itself.

We designed a 6-question survey questionnaire administered anonymously through Moodle at the end of the workshop. It consisted of four 6-point Likert scale questions, a 'Yes/No' question and one open-ended question. The survey instrument was developed to explore the instructor pedagogical beliefs based on three main constructs – Instructor perception of usefulness of active learning and ICT (number of items = 2), Instructor understanding of Active learning (number of items=2), and Instructor perception of implementing active learning with ICT (number of items = 2).

Within the context of professional development programs like T10kT, this means that there is a need to explore whether instructors require additional support for enacting espoused beliefs. Keeping this in mind our questionnaire had the following Likert scale questions:

Construct = Pedagogical belief (Perception of usefulness)^{[1][1]}_[SEP]

- Q1. Active learning strategies will be useful for my teaching. (Likert scale)^{[1][1]}_[SEP]
- Q2. Visualizations like animations and simulations will be useful for my teaching. (Likert scale)^{[1][1]}_[SEP]

Construct=Pedagogical belief (Understanding of active learning)^{[1][1]}_[SEP]

- Q3. I use active learning in my classroom (Y/N)^{[1][1]}_[SEP]
- Q4. What active learning strategies do you use in your classroom? (open-ended)^{[1][1]}_[SEP]

Construct = Need for support^{[1][1]}_[SEP]

- Q5. I need training on how to implement active learning strategy in my class. (Likert scale)
- Q6. I need stepwise guidelines on how to implement program visualizations with active learning strategies in my class. (Likert scale)

We did validity and reliability testing for our instrument. The face validity of the instrument was established after conducting two iterations of refinement with two experts in teacher professional development. To establish construct validity we conducted Principal Component Analysis (PCA) on the Likert scale questions. All the communalities were found to be above 0.56. We chose orthogonal varimax rotation and resulting rotation corresponded well with our grouping of items into two criteria of ‘perception of usefulness’ (factor loadings of Q1=0.868, Q2=0.765) and ‘need for support’ (factor loading of Q4=0.910 and Q5=0.903). The reliability of the survey instrument was established through Cronbach’s alpha value of 0.70.

Data Analysis Procedure

Study-I consisted of two stages of data analysis. The first stage involved analysis of the ordinal data (N=3688) from Likert-scale using percentage and frequency distribution. We also analyzed the association between the variables within the construct of perception of usefulness of active learning and ICT- ‘usefulness of active learning’ and ‘usefulness of ICT’, using Spearman’s rank-order correlation. The second stage involved analysis of only those responses where instructors had given detailed description of the type of active learning they do in their teaching (N= 1802). Content analysis of the responses was done to categorize the understanding of the teachers about active learning. We used open coding followed by axial coding to classify the teacher conceptions (Table 4.2).

The following definitions of active learning was used for this classification: ‘[Active learning activities] have the three common features: a) They are explicitly based on research on teaching and learning of the subject, b) They incorporate classroom activities that require all students to express their thinking through speaking, writing, or other actions that go beyond listening and copying of notes c) They have been repeatedly tested in actual classroom settings and have provided objective evidence of improved learning.’ (Meltzer and Thompson, 2012). Two researchers, with good inter-coder agreement (Cohen’s kappa = 0.84, $p < 0.05$), performed the coding. We further analyzed the reported need for support against the identified classifications.

Table 4.2: Example of coding scheme of instructor conceptions of active learning

Instructors' Response on AL strategies used (verbatim)	Open Code	Axial Code
In the classroom, I am using LCD projectors to show the animations and simulations to the students	Use projector to show visualization	Mere use of ICT without exploiting its affordances for constructivist practices
I use video tutorials and interaction with the students using quiz questions.	<ul style="list-style-type: none"> • Use internet-based resources • Conduct quiz [L] [SEP] 	<ul style="list-style-type: none"> • Mere use of ICT without exploiting its affordances for constructivist practices • Use of assessment strategies
Using Moodle for conducting quiz	Use MOODLE for quiz	<ul style="list-style-type: none"> • Mere use of ICT without exploiting its affordances for constructivist practices • Use of assessment strategies
Teachers' evaluation component like Quiz, Surprise test	Take tests	Use of assessment strategies
A short video about the topic is given day before, and on the day of lecture, an important algorithm is explained and a question worksheet is given, to let them share answer peer wise, using think pair share wise and finally explain their doubt.	Use 'Think-Pair-Share'	Identical conception of active learning as provided by literature

4.1.3 Results

Result 1.1: Usefulness of active learning strategy

We first look into the construct of 'Instructor perception of usefulness' and 'Instructor need for support' from the survey results. As seen in Table 4.3 (below), the survey results indicate that there is a high perception among the instructors about usefulness of active learning (88%) and Visualizations (73%). We found significant correlation between teacher perception of usefulness of ICT and usefulness of active learning as an instructional strategy ($\rho = 0.6573$, $p < 0.05$). 68% of instructors positively agreed that they would require support (in terms of training) for implementing active learning in their classroom. When asked about implementing visualizations along with active learning, nearly 73% have also indicated the need for scaffold (in terms of guidelines)

Table 4.3: Frequency of perception about teacher acceptance and teacher confidence in active learning and visualization

Perceptions (N=3688)		Disagreement			Agreement		
		1 (Strongly Disagree)	2	3	4	5	6 (Strongly Agree)
Instructor perception of Usefulness	of Active Learning	86 (2%)	86 (2%)	292 (8%)	806 (22%)	982 (27%)	1436 (39%)
	of Viz.	54 (1%)	74 (2%)	215 (6%)	546 (15%)	1005 (27%)	1794 (49%)
Instructor Perception of requirement of support in	Implementing Active Learning	162 (4%)	365 (10%)	615 (17%)	893 (24%)	695 (19%)	958 (26%)
	Viz. integration	146 (4%)	286 (8%)	509 (14%)	852 (23%)	807 (22%)	1088 (30%)

Result 1.2: Conceptions about active learning strategy

The content analysis of open-ended question on the active learning strategies used by the instructors’ practicing active learning in classroom showed that there exist five different categories of conceptions about understanding of active learning among the instructors. An example of our coding scheme is shown in Table 4.2. These categories are:

- a. *Category A* – Mere use of ICT without exploiting its affordances for constructivist practices: Instructors with these category conceptions use the tool for information acquisition and regurgitation. Hence students do not achieve higher order thinking skills that should have been possible if the strategies were truly active learning.
- b. *Category B* - Use of Assessment Strategies (like Quiz): Instructors, within their limited available time, try to assess lower order cognitive abilities of students. The instructors are interpreting this as active learning.
- c. *Category C*- Providing Home Assignments: Instructors having this conception does not involve students in any in-class activity, even as follow up.
- d. *Category D*- Instructor-directed interaction with students. (e.g. Asking for doubts, Explanation using real time examples etc.)
- e. *Category E* – Identical conception (with definitions of AL): These teachers reported use of research based strategies like Think-Pair-Share, which required students to think beyond routine task and engage in higher order thinking.

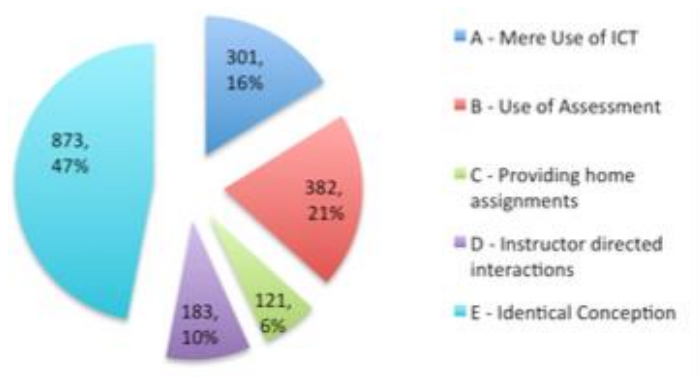

Figure 4.2: Varying conception of Active Learning among Engineering instructors

It was seen that 47% of these instructors fell under Category E, that is, had a conception about active learning consistent with the accepted definition while the remaining 53% subscribed to the various alternate conceptions (Categories A- D) about active learning (Fig 4.2). For further analysis we grouped the four categories A- D into one group defined as ‘instructors having alternate conceptions (to the accepted definition)’, and denoted category E as ‘instructors’ with conception of active learning consistent with accepted definition’.

Result 1.3: Need for support in implementing active learning

The instructor responses to perceived need for support were then collapsed into a binary category (of Agreement and Disagreement) and compared against instructor conceptions of active learning (Table 4.4).

It is seen that:

- a) The majority of participants reported that they needed support in implementing active learning with ICT (75%).
- b) Participants’ conceptions of active learning (either consistent with accepted definition or an alternate conception) did not matter when it came to the need for support, as similar numbers of participants in both categories of conceptions expressed the need for support.

Table 4.4: Conception of active learning vs Need for support in implementing active learning

Need for support for implementing active learning strategies	Alternate Conception of Active Learning	Identical Conception of Active Learning
Agreement	774	659
Disagreement	313	214
TOTAL	987	873

4.2 Exploratory Study 2

4.2.1 Overview of the training programme

This training was also done as part of T10kT in a blended mode with the focus of training in-service teachers to systematically inquire their own practices with technology and conduct classroom action research. The training programme contained two days of synchronous sessions separated by a week of asynchronous online activities. The second synchronous session was followed by another week of online activity. Thus there was a total of 12 hours each of synchronous and asynchronous sessions. The training environment was similar to the one used in exploratory study 1 (Figure 4.1). A total of 5943 participants registered for the programme from 204 different remote centers.

Prior to the first synchronous session, participants were asked to fill a pre-workshop assignment that guided them to reflect on their own practice and identify a potential idea that they could systematically inquire. The first synchronous session, then familiarized participants with the various methods that will assist them in the process of inquiry along with the measures of Novelty, Positioning, Soundness of Procedure and Evidence, which are used to evaluate an inquiry study (Smith, 1990). This session ended with participants being exposed to a take-home assignment that provided detailed guidelines to convert their initial idea to an idea amenable for classroom action research. Participants were expected to complete this assignment during the following week. They were provided with asynchronous support using the discussion forum in MOODLE. The second synchronous sessions following this week provided them with knowledge about various research methodologies. This included discussions on various research designs, choosing a sample, creation and validation of instruments, and ethics. The research design process was illustrated with practical examples of three existing experimental research studies of engineering college teachers. These sessions included exercises so that participants could get enough time to practice. At the end of this session, participants were provided with another take-home assignment which provided them guidelines on converting their action research idea into systematic educational research study.

To ensure that participants get sufficient exposure to active learning strategies, we had adapted active learning strategies within the synchronous sessions by making use of features available within the learning environment (A-VIEW Chat and Remote center Coordinator).

4.2.2 Research Design

We used a mixed-method study to identify effectiveness of the training in this exploratory study. Effectiveness of training constituted of three different components – Perception of engagement and learning, Actual engagement in the training and Actual learning gains in the training

Research Questions

- i. What was the rate of participation in the workshop?
- ii. What was the improvement in the participant's knowledge of research methods, both (a) measured and (b) perceived?
- iii. How satisfied were the participants with the workshop?
- iv. How do participants' perceptions of the usefulness of active learning strategies affect their overall satisfaction?

Sample

There were 5943 registered participants to the workshop; however, only 3896 out of them were involved at any stage within the workshop. The remaining never participated in any stage of the workshop, and they can be considered to have dropped their registration before the workshop began. To answer the research question related to the rate of participation within the workshop (RQ. i), we examine the number of participants at key stages of the workshop involving assignment submissions. To answer the research question related to measured learning gains from the workshop (RQ ii), our study utilizes data from 242 participants who submitted assignments at each of the key stages during the workshop. To answer questions related to the perception of learning (RQ ii), and satisfaction (RQ iii), and usefulness of active learning strategies (RQ iv) we utilize survey responses of 1286 participants who have given us consent to utilize the data.

Instrument

We have utilized three different instruments to collect data. To gather perception related data we have used a survey questionnaire. The participants were administered with a perception survey questionnaire which contained 18 questions on a five point Likert Scale (from Strongly Disagree to Strongly Agree). The questions relate to participants' perception of their learning from the training, and their overall satisfaction with the training. The survey was administered to the participants after the end of second synchronous day, via Moodle. An example of an item that addressed participants' perception of learning was, *"As a result of the workshop, I feel confident of tackling educational technology research problems"*. Another example that addressed usefulness of active learning strategies was, *"I found the activities such as 'Think-Pair-Share' and 'Voting' helpful for improving my understanding of concepts learnt"*. Another question which targeted the satisfaction of participants' was : *"Overall I am satisfied with the Workshop."* The survey also captured the open ended responses of the participants' perception of the elements of the training.

To capture the learning, we used the two take-home assignments provided to the participants to elicit their idea and plan the action research study. The assignment for eliciting the idea consisted of 11 guiding questions, each of which targeted specific criteria of Novelty, Positioning, Soundness of Procedure and Evidence that were the evaluation criteria for an action research study (Smith, 1990). For example, to address the positioning of research study there were questions on identifying existing journal articles and analyzing participants research idea in terms of the work in those papers. In order to address the criterion of soundness of procedure, the assignment contained questions related to the intervention in the study, such as: *"What will the instructor do?"* and *"What will the students do?"*. The questions to address the criteria of evidence was *"What evidence you will collect to show that your idea works"*. The second take-home assignment for detailing the action research study had three sections: setting up the problem (addressing novelty and positioning), explaining the solution (addressing soundness of procedure), and defending the solution (addressing soundness of procedure and evidence). Thus the quality of responses to questions in each of these section provided a direct measure of participants learning from the workshop.

Data Analysis Techniques

Literature provides terminologies like completion, persistence, retention or drop-out rates while looking at participation in similar large scale distance programs (Levy, 2007; Nicholas, 2010). These terms look at continuous engagement of a participant within the program and impose a strict filter on the actual participation. We calculate the strict ‘persistence rate’, that is, the number of participants completing all assignments to answer the research question on participation (RQ i).

Participants’ responses on the two take-home assignments were analyzed using a rubric. The rubric consisted of four dimensions of evaluation, corresponding to the criteria of novelty, positioning, soundness of procedure and evidence. Each dimension was evaluated on a 4-point scale: Very Low, Low, Medium and High, each of which had detailed descriptors relevant to the dimension being evaluated. The transition from the idea (assignment 1) to action research study (assignment 2) scores was analyzed to determine the measured learning gains from the workshop. The rubric was checked for validity and reliability before calculating the final scores. The inter-rater reliability was checked with three different graders and the kappa values were found to be more than 0.6 for each of the dimensions.

The survey responses were analyzed using frequency analysis of Likert Scale questions to answer RQ iii and the rank correlation was calculated between the responses to overall satisfaction and usefulness of active learning strategies to answer RQ iv.

4.2.3 Results

Result 2.1: Low persistence rates comparable with rates observed in large-scale courses

We see that there was a high involvement during the initial stages of the workshop, with more than 2000 participants (>55%) (2215 for pre-training assignment and 2311 for take-home assignment 1) submitting these. However the participation dropped as the training progressed. 28.9% actively participated by submitting at least two of the four key assignments provided in the training and 17.9% completed the final take-home assignment (assignment 2). The persistence rate, that is, those completing each

and every assignment are low (6.2%) and comparable to those reported in Massive Open Online Courses (Nicholas, 2010; Jordan, 2011).

Result 2.2: Low learning scores but statistically significant gain across assignments along with a strong perception of learning

The actual scores reflected an improvement of mean from 2.9 at assignment 1 stage to 4.8 at assignment 2 stage. The score is however very low as the maximum possible score was 12. Wilcoxon signed-rank test performed on the results showed that the difference in mean scores between IPT and SPT was significant with $Z=-12.4969$, $p<0.001$ with a large effect size ($r=-0.566$). The survey responses show that 85.93% of the participants either strongly agreed or agreed that they learnt from the training.

Result 2.3: High perception of satisfaction from the workshop

93.71% of the participants expressed satisfaction with the training. However many had indicated the lack of time due to academic workload and technology failure as a serious deterrent to completion of the assignments and training satisfaction. Both these parameters were beyond our control within the current training. A possible way of tackling the first concern is by organizing the trainings at a time when the teachers have least academic workload (like semester holidays, or start of semester).

Result 2.4: Rank Correlation coefficient (γ) = 0.75

The values for correlation coefficient (γ) of usefulness of active learning strategies were found to be 0.75.

Apart from this, another important observation while analyzing the submissions in this training is that majority of the teaching-learning ideas rely on a teacher-centered strategy with reliance on presentation of ICT (like showing powerpoint slides, video, webpage etc). This observation is similar to the alternate conceptions A (Mere use of ICT) and E (Instructor directed interactions) for active learning strategies found during exploratory study 1.

4.3 Implication of the Results

The results from both the exploratory studies provide us with insights on the following aspects within our context of training within engineering education:

- Positive inclination towards usefulness of active learning strategies – High perception of usefulness of active learning strategies (Results 1.1 and 2.4) indicates positive inclination of participants towards these practices. This is crucial because this will lower second order barrier related to attitude and beliefs towards student-centered strategies while integrating technology (Ertmer, 1999).
- Challenges for introducing effective teaching-learning practices while integrating technology – Though results 1.1 and 2.4 show a positive inclination towards active learning strategies, there exists varying conceptions about active learning among the participants (result 1.2). With more than 75% of participants indicating need for support in implementation of active learning (Result 1.3), this indicates a higher third order barrier (Tsai and Chai, 2002) towards design of effective learning strategies with ICT. A possible solution to this challenge is training programmes catering to constructive alignment
- Challenge of sustaining effective teaching-learning practices while integrating technology - The low scores in teacher reflection (result 2.2) also indicate the challenge of training teachers to reflect on their own practice. Teachers need to be able to reflect on their own practice and proceed to inquiry of the practice to sustain training benefits (Strevler et. al., 2012). Thus the training designer need to explicitly keep the goal of sustainability of effective practices while designing the training programmes for our context.
- Technology selection – From both the studies, we see that many teachers still rely on presentation tools for teaching-learning practices in classroom (Result 1.2 and observations in exploratory study 2). A major implication of this result as a training designer would be the challenges involved in introducing new technology tools that provide affordances of increased learner interactions. Typically the participating teachers are expected to move from student learning experience to expert learning design experience with the new technologies over the course of training, which can become a steep learning curve.
- Usability of existing platforms for scaling – The exploratory studies served as a feasibility study of the existing teaching-learning environment (synchronous interactions using A-VIEW chat and asynchronous interactions using

MOODLE) for implementing the training. As seen from exploratory study 2, face-to-face active learning strategies can be adapted in the new learning environment and is found to have higher correlations ($\gamma = 0.75$) with learning and training satisfaction (result 2.4).

- Persistence of participants while scaling – These studies also pointed to another important issue to consider while scaling: ‘Persistence rate’. It is defined as the number of participants who successfully complete the training to those who actively participate in it. Since scaled training platform available in the context uses a distance mode, the issue of participant attrition is very high (Result 2.1). Thus the training designer needs to also identify means of engaging the participating teachers throughout the duration of training programme.

4.4 Broad Training Goals

The broad research problem of design and delivery of training program for teacher technology integration in Indian engineering education can now be understood as satisfying the following goals:

- A. In terms of training program design
 - a. To train participants in research based student centric strategies for effectively integrating technology
 - b. To design scaffolds for these student-centered strategies that will assist participants during training as well as implementation in their classrooms
 - c. To train teachers in action research of teaching-learning practices in the use of technology tools to ensure sustainability
- B. In terms of program delivery:
 - a. Adaptable in multiple instructional modes, viz. face-to-face, Blended Online Mode, Online Mode, etc. to achieve scalability.
 - b. Promote higher persistence rates

Chapter 5

A2I2 Model

The broad problem statement that is being solved in this thesis is “How can we improve the design and delivery of large-scale training programmes to in-service faculty in Indian engineering education, to enable them in effectively integrating ICT tools within their teaching-learning context?” The analysis of existing literature, done in chapter 2, present us with two broad research goals:

- I. Development of a scalable model that will assist in implementation of TPD programme for technology integration.
- II. Implement and evaluate the effectiveness of the training programmes created from the model.

Based on the initial exploratory studies, detailed in chapter 4, we have also identified the specific goals related to training programme design and implementation. The ‘*Attain-Align-Integrate-Investigate*’ (A2I2) Model for design of technology integration training programmes is our proposed solution to answer this broad research problem.

In this chapter we provide a detailed description of the model, its evolution and the design principles that help in design and implementation of training programmes based on the model. In section 5.1 we provide an overview of the model presenting both its structural and functional views, which is followed by the theoretical basis of the model in section 5.2. The evolution of the model through the DBIR process

within this research is presented in section 5.3 before introducing the design principles that emerge from this research in section 5.4. The detailed model in section 5.5 follows this.

5.1 Overview of the Model

The A2I2 model is the solution proposed to tackle the need for a scalable model to design and implement technology integration training programmes for in-service teachers in the engineering education. The model is named after its four constituent phases viz. Attain, Align, Integrate and Investigate. To provide overview of A2I2 model, we present both its structural and functional views to detail the contents, sequencing of contents and operationalization during the training.

5.1.1 Structural view of A2I2 model

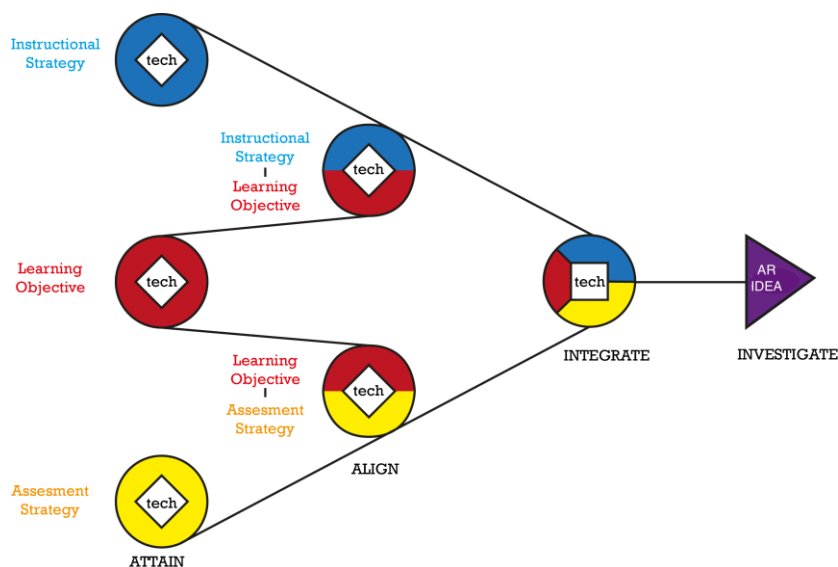

Figure 5.1: Structural view of the A2I2 Model

Figure 5.1 shows the structural view of the model, indicating the key contents and their sequencing. The structural components of circles and triangle in the figure represent the content of training, while the parallelograms represent use of technology as either the content or facilitation medium. The tangential lines drawn on the circles indicate progress of the content across the four phases. The use of two or more colours in a circle represents the integration of these contents. As the phases progress,

the contents are aligned with the learning outcomes and integrated to form a lesson design.

The model contains five basic contents, indicated by the five colours, viz. Learning outcomes (LO) in red, Instructional Strategy (IS) in blue, Assessment Strategy (AS) in yellow, Technology to be integrated (tech) in white and action research (AR) idea in purple. The first four (LO, IS, AS and tech) are the building blocks of a technology integrated lesson design while action research helps participants reflect on their lesson design activity. LO is kept at the centre, as choice of LO directly impacts all the other contents and is also crucial for effective technology integration. Thus while moving across the four phases of Attain, Align and Integrate, the AS and IS are aligned to LO to finally generate an integrated lesson design with technology. This lesson design is used for generating an action research idea that can be taken up by the teachers to evaluate their own practice.

5.1.2 Functional view of A2I2 model

The functional view of the model (Table 5.2) helps in operationalization of the model into training programme for technology integration. This view emerges from the reflections that we obtain after implementing the model as a training programme and then evaluating it. These reflections provide us with guidelines or heuristics regarding certain processes and conditions that works in the operating context. These guidelines are called the ‘design principles’ emerging from the research.

Three design principles, Immersivity, Pertinency and Transfer of ownership (detailed in section 5.4), emerge from evaluation of the training programmes designed from the model. These design principles inform the operationalization of the model within the training and is shown in the functional view of the model (Table 5.2). Here ‘level of immersion’ is informed by design principle of ‘Immersivity’ and ‘pertinent output’ in each phase is informed by ‘Pertinency’. ‘Transfer of ownership’ informs the sequence of activities in ‘investigate’ phase.

- In the ‘Attain’ phase, focus should be on introducing participants to the idea of student-centeredness. This would require participants be introduced to knowledge on the four core contents (*‘Learning outcomes’*, *‘Instructional Strategies’*, *‘Assessment Strategies’* and *‘Technology’*) with student-centered

focus. Since each of these contents is only introduced in this phase, the content/technology mastery is not expected from the participants. Hence majority of the activities within this phase will be instructor driven like lecture, summary, explanation of affordances of technology etc. The design principle of ‘Immersivity’ recommends that participants be immersed in the use of the technology, which needs to be integrated, as a student in this phase for designing independent learning artefacts. The design principle of ‘Pertinency’ recommends that the participants’ generate independent learning artefacts for their own course.

Table 5.1: Functional View of the model

Phase	Focus	Level of Immersion (Informed by Immersivity)	Pertinent Output (Informed by Pertinency)	Nature of activity
Attain	Introduction to student-centeredness	Exploration of technology feature as a student	Independent learning artefacts for own course	Instructor-directed
Align	Alignment with student learning goal	Exploration of technology as a teacher	Learning Artefacts designed for the student learning goal in own course	Participant driven (individual)
Integrate	Technology integration design	Selective use of technology as a teacher	Integrated artifact for a lesson design in own course	Participant driven (collaborative)
Investigate (Informed by Transfer of Ownership)	Evaluating effectiveness of practice	Identifying metrics of evaluation of selected features	Ideas for action research in own course	Participant driven (collaborative)

- In the ‘Align’ phase, focus is on aligning strategies with student learning goals, while using technology. Thus there is an increasing depth in the coverage of contents that requires participants to practice individually. The participants are expected to have some mastery on the content and technology by the end of the phase as the designed activities increase in complexity. Since mastery is targeted there will be more of participant driven individual activities. The design principle of ‘Immersivity’ recommends that participants be immersed in the exploration of the technology, which needs to be

integrated, as a teacher in this phase for identifying various technology features aligned with student learning goals. The design principle of 'Pertinency' recommends that the participants' generate learning artefacts aligned to student learning goals for their own course.

- In the 'Integrate' phase, the focus of the training is to enable technology integration design through constructive alignment of learning outcomes with instructional strategies and assessment strategies by appropriate integration of technology. The complexity and depth of each of the content becomes largest in this phase. Hence participants are primarily engaged in a collaborative activity to solve the real-life teaching-learning problem faced by them in class, as recommended by design principle of pertinency, using lesson designs that integrate technology. The design principle of 'Immersivity' recommends that participants be immersed in the selective use of the technology features, which needs to be integrated, as a teacher in this phase.
- In the 'Investigate' phase, the entire activities are informed by design principle of 'Transfer of ownership' that recommends that participants take the ownership of the problem of practice in their own course. This helps in focusing the training to help participants' in evaluating effectiveness of their own practice. The design principle of 'Immersivity' recommends that participants be immersed in identification of metrics associated with the features of technology chosen by them in the integrate phase.

From the functional perspective, A2I2 have an overlap with the Design, Development and Implementation phases in the ADDIE model. However it differs from the ADDIE in the following ways:

- The A2I2 model addresses an explicit need of "improving learning design skills of in-service instructors" with the context being scaled programs mediated through technology. Thus it has captured the Audience Need Analysis and Training Environment Analysis implicitly.
- The phases of Attain, Align, Integrate and Investigate, specifically provides instructions on the content to be focused along with nature of activities across each phases of the training. Thus it provides more detailed

information to the training program designer on what has to be done at each phase compared to the broad directive in ADDIE.

- The A2I2 model additionally provides the level of pertinency of content and immersivity in the learning environment required for effective training. Thus it assists the training program designer in the implementation of the training design across diverse settings and scale.
- By specifying a tangible output at the end of each phase, A2I2 provides a useful artifact that can be evaluated for identifying training effectiveness, while implementing the training at scale.

5.2 Theoretical Basis

The major theoretical basis of the A2I model that helps decide the content of the training program is *constructive alignment* (Biggs, 1996). This is achieved when the teaching-learning activities and evaluation are aligned with the intended student learning outcomes. Constructive alignment also ensures that instructors utilize more constructivist, learner-centered practices while performing this alignment. Constructive alignment has been successfully employed by instructors in course redesign (Trigwell & Posser, 2014) and is known to promote deep learning among students (Wang et. al., 2013).

Spiral curriculum (Bruner, 1977) forms the basis of the organization and sequence of topics in training programmes guided by the A2I model. Spiral curriculum is characterized by an iterative process of revisiting the contents, with successive iterations looking at the topic in a greater depth for the learner to build on his initial understanding (Harden and Stamper, 1999). Thus when the teacher is faced with a complex task of learning how to solve his/her teaching-learning problem, the spiral approach of training provides the necessary time and depth to understand and apply relevant teaching-learning principles.

Active learning (Prince, 2004) forms the basis of the pedagogical strategies followed in training programmes based on the A2I model. Based on constructivist teaching-learning philosophy, active learning encompasses several research-based strategies designed to engage students in the learning process, in which students go beyond listening, copying of notes, and execution of prescribed procedures (Meltzer &

Thornton, 2012). The activities within the A2I2-based training programmes are designed using active learning strategies so that participants not only get engaged in the learning environment of the program, but also get exposed to student-centric strategies that they may then try in their own classrooms.

5.3 Evolution of the Model

The A2I2 model was developed alongside the longitudinal TPD project “Educational Technology for Engineering Teachers” (ET4ET) and has evolved out of five design and implementation iterations in three different modes. The model was created to design training programmes targeting effective technology integration for engineering college teachers.

Table 5.2: An overview of evolution of the A2I2 model

Training Iteration	Iteration 1 (ET4ET ₀)	Iteration 2 (ET4ET ₁)	Iteration 3 (ET4ET ₂)	Iteration 4 (ET4ET ₃)	Iteration 5 (ET4ET ₄)
Model Version	Model ₀	Model ₁	Model ₂	Model ₃	Model ₄
Started	Jun, 2013	Jun, 2014	Jan, 2015	Jun, 2015	Jan, 2016
Mode	Face-to-Face	Blended Online			Massive Open Online
Number of Participants	23	1300	4358	51	5105
Scale	1x	~56x	~189x	~2x	~221x
Focus of training	Technology Integration	Scaling Technology Integration	Scaling Technology Integration	Sustaining Technology Integration	Scaling Technology Integration
Technologies Trained	Visualization	Visualization, Wiki, Screencast	Visualization, Wiki, Screencast	Wiki, Padlet	Visualization
Impact on Model	A2I refined and A2I2 created	Design principles emerge	Inputs on the idea of sustainability	Refined investigate phase	A2I2 scaled
Detailed in	Chapter 6	Chapter 7			Chapter 8

Table 5.2 provides an overview of the evolution of the model. As seen from the table, the trainings (Iteration₀ to Iteration₄) were implemented in three modes – face-to-face, blended online and massive open online, and were spread across three years. These iterations helped in scaling up the training programme implementation from 23 participants in Iteration 1 to 5105 participants in Iteration 5 (i.e. scaling factor of nearly 221). Iteration 1, done in face-to-face mode was a pilot implementation of the model, and hence done at a low scale. However after this iteration, except for Iteration 3, all the subsequent iterations had a focus on scaling up technology integration training programmes. The focus of iteration 3 was to explore the sustainability of

training benefits. Participants were trained in technologies of visualizations (videos, animations and simulations), screencasts (primarily used in flipped classrooms), wikis and padlet.

As seen in Figure 5.2, training programmes in each of these iterations (ET4ET₀ to ET4ET₄) was evaluated using DBIR methodology and the reflections from these evaluations were used to refine the model (Model₀ to Model₄). The model was then used to design and implement the next iteration of training programme. The initial iteration (Iteration 1) considered only the A2I phases of the model (Model₀) while designing and implementing the training in face-to-face mode. Thus the evaluations in the first iteration helped in refining the A2I model to add the final investigate phase and create the A2I2 model.

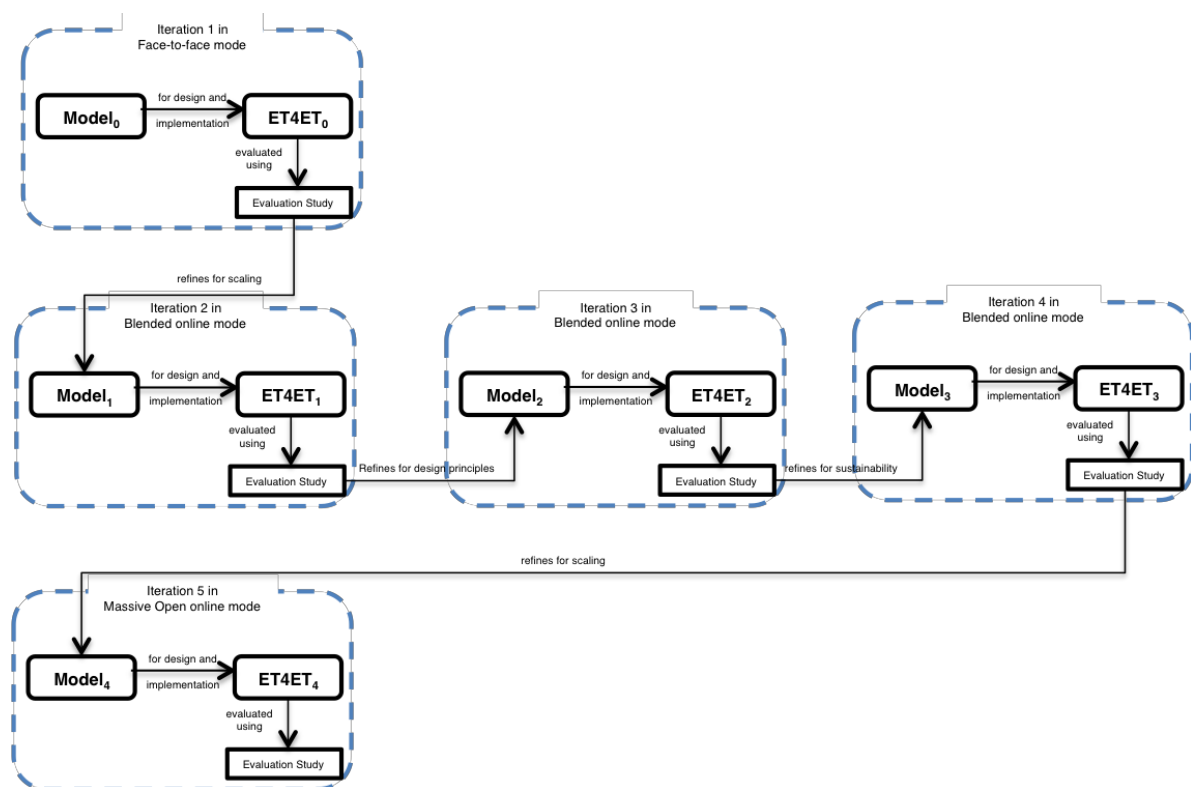

Figure 5.2: The design-implement-evaluate-refine cycle of model using DBIR methodology. This model (Model₁) was then used in Iteration 2 to scale up the training, and was implemented as ET4ET₁ in blended online mode. The reflections from evaluation of the second iteration provided inputs on the design principles of ‘Immersivity’ and ‘Pertinency’, which was now made explicit in the A2I2 model. This refined model (Model₂) was then used in Iteration 3 to further scale up training and was

implemented as ET4ET₂. The evaluations from this iteration provided inputs on the sustainability of the training that was used to refine Model₂ to create Model₃.

The refined model (Model₃) was then implemented in Iteration 4 (ET4ET₃) with a prime focus on sustainability. The evaluation of this training provided inputs to refine the investigate phase of the Model₃ to generate a refined Model₄. This refined model (Model₄) was now used to scale up the training in a massive open online mode (ET4ET₄). With implementations scaled across three different modes that helped in generating five different versions of the model, it became necessary to synthesize the various results and reflections before attempting to use the model to either scale up or sustain the training.

5.4 Design Principles of A2I2 Model

Design principles are defined as “heuristic statements in the meaning of experience-based suggestions for addressing problems” (Plomp, 2013). These are always associated with the operating context in which they were developed, and do not guarantee generalizability. The design principles emerge from evaluation of the interventions and subsequent reflection by the designers. Van den Akker (1999) classifies the design principles into two: Procedural design principles and Substantive design principles. While procedural principles are characteristic of the approach or exact procedures performed during the intervention, substantive principles are characteristic of the intervention or the design.

Since design principles emerge from the reflections of implementation and evaluation, it is important to understand them as it provides information on strategies that worked in the context. Within the current context of scaling up, we identify three design principles that will help in improving design of training. .

5.4.1 Immersivity

Immersivity is defined as the feature of the learning environment that drives participants to be involved in a set of meaningful activities (Howland et. al., 2012) and to get cognitively engaged in the content (Sherman & Craig, 2003). Immersivity is built upon the need for having active learning within the training environment

(Desmione, 2009) by adding the concept of immersion (Calleja, 2007), prevalent in the virtual reality and gaming literature.

Researchers have noted the need for paralleling or mirroring student-learning experience within teacher professional development programmes for effective professional development (Ebert-May et. al, 2011; Lockus-Hearsely, Stiles and Hewson, 1996). The design principle of *Immersivity* considers the participant teachers as learners first while introducing any new practice or technology. The training environment and activities are designed to ensure active learning among participants while engaging with the training content. This ensures that teachers obtain first-hand experience of student learning within the training, leading to a higher probability of programme effectiveness.

5.4.2 Pertinency

Pertinency of teacher training content is defined as the training participant's perception of degree to which the given content is applicable for his/her teaching immediately after the training. This idea builds upon the element of job relevance (Venkatesh & Davis, 2000) by adding the constraint of immediate practice. Studies have shown that teachers positively value the experience of using their own learning contexts for practice within the training programme (Uycal, 2012). The design principle of *Pertinency* ensures that training designer chooses relevant content and examples to the teacher's immediate practice, and thereby increases possibilities of sustained impact immediately after the training (Fullan, 2001; Hayes, 2000).

5.4.3 Transfer of Ownership

Transfer of Ownership is defined as the planned action of shifting the focus of teacher professional development from the trainer to the participant teacher, by trying to solve teaching-learning problems within the context of the participant. Though pertinency also contribute towards creating relevance to the training content, the "Transfer of Ownership" explicitly ensures that the problem of effective technology integration now becomes a problem of the participant. Inside the model, this is achieved by training participants in generating an idea to perform classroom action research (CAR) in the technology integration lesson plan created by them during 'Integrate' phase. CAR allows teachers to carry out systematic inquiry in their own practice and

enable them to improve their understanding of the pedagogy and thereby improve student performances (Norton, 2009). Within the broad continuum of action research, CAR method fits between personal reflections and formal educational research (Mettetal, 2012). Apart from the reported student benefits and institutional benefits, CAR is known to have benefits of greater sustainability and empowerment among the teachers (Bradshaw et. al, 2014). Thus Transfer of Ownership includes and goes one step beyond enlisting interest and stimulating buy-in. Teachers begin reflecting on their own practice and make systematic evaluations to improve their practice. Classroom Action Research training is one of the mechanism to make the teachers reflect on their own practice.

5.5 The A2I2 Model

While the structural and functional views provide an overview to the model and design principles provide indications for implementation, these are not still directly usable for training designers as a complete model. Thus there requires a further level of detailing which will synthesize the different aspects that were familiarized and is in a form that is directly consumable by training designers. This form is given in tables Table 5.3 and Table 5.4 and is called the A2I2 model. While table 5.3 explains the features in the model across all the phases, table 5.4 explains the format of activities available. The key elements in the model are:

- *Phases* - There are four phases viz., Attain, Align, Integrate and Investigate that is based on the various contents at differing depth.
- *Focus* - This specifies the focus of the designed activities in each phase.
- *Content* - This deals with content dealt within the phase. It is further subdivided into
 - *Topics* - This specifies the various sub-topics dealt under the three main modules of Learning outcome, Assessment Strategy and Instructional Strategy.
 - *Level of knowledge* - This specifies the level of knowledge expected from the participants at the end of each phase
- *Format* - This refers to the way sessions are held in each phase. The detailed split up of format is provided in Table 5.4 below. A single session comprises of several

activities that involve specific actions by the instructor and participant during the teaching-learning interactions. There are 3 main types of activities viz., Instructor Driven, Participant Driven Individual, Participant Driven Collaborative. The role of participant varies from a learner to that of a teacher across the various activities as shown in Table 5.3. The duration of an activity is also a key aspect, as studies show that the average attention span of an adult learner is nearly 20 minutes (Dukette & Cornish, 2009), which necessitates the span of instructor led activities to be lesser.

- *Instructor Led* - These are activities in which the instructor plays the major role. E.g. Lecture, Presentation, Summary etc. The activities are designed so that the role of the participant within these is that of an active learner.
- *Participant Driven Individual* - These are activities in which the participant performs the task individually and turns to instructor only for feedback. E.g. working out an example individually, solving a question etc. Since participants are solving real life teaching-learning problems, the role of participant becomes that of a teacher during these activities.
- *Participant Driven Collaborative* - These are activities in which participants work in a group to solve a problem or perform an activity posed by instructor. E.g. Think-Pair-Share or Peer Instruction. These activities will have the maximum complexity and would require the participant to move back and forth between the roles of a teacher and a student.
- *Immersion of Technology* – This explains how the learner gets exposed to the technology at each level. The level of immersion is informed by the design principle of ‘Immersivity’
- *Output* - This specifies the tangible output at the end of each phase, and additionally provides the learner with direct application of the knowledge learnt and the needed reflection on outcomes. The output of each phase is informed by the design principle of ‘Pertinency’ that recommends all the outputs to reflect the participants’ own course.

Table 5.3: Features of A2I Model

Phase	Focus	Content		Format of activities	Immersion in Technology (Informed by Immersivity)	Output (Informed by Pertinency)
		Topic	Level of knowledge			
Attain	Attains Introduction to concepts	The topics of each session is one of the three core modules of - Learning outcome (LO), Instructional strategy (IS), Assessment strategy (AS)	Sessions in the Attain phase target <i>recall</i> or <i>understand</i> type of knowledge (Anderson & Krathwohl, 2001) related to development of learning outcomes, use of instructional strategies or selection of assessment strategies with the chosen technology. For example, how to write a correct learning outcome achievable with the technology, or how to execute the steps of a particular instructional strategy with the technology.	Most activities are instructor-led, such as introduction to concepts, summary. Duration of each activity: 5-15 minutes.	More instructor guided activities using technology before explanation on the affordances of technology	Identification of learning outcome (LO), Instructional strategy (IS) and assessment strategy (AS) relevant to their own course.
Align	Aligning learnt modules pairwise along with deeper knowledge.	The topics of each session is any two of the three modules of alignment in: <ul style="list-style-type: none"> • LO and IS • LO and AS • IS and AS 	Sessions in Align phase targets <i>apply</i> level of knowledge related to use of an instructional or assessment strategy for achieving a learning outcome, or choice of a technology with an instructional strategy for a particular learning outcome.	Majority are participant-driven individual activities such as constructing material for own course, micro-teaching.	More of evaluate level activities followed by instructor-guided activities so as to align the affordances of technology with its intended use.	Examples of pairwise aligned modules within their own course: <ol style="list-style-type: none"> a) LO - AS b) LO – IS c) IS - AS
Integrate	Integrating the knowledge gained.	The topics are meant for integrating LO-IS-AS	Sessions in integrate phase target <i>create</i> level of knowledge for combining the three core modules. e.g., creation of lesson plans with the use of a specific technology.	Most activities are participant-driven and collaborative in nature for example, writing a lesson plan in a group,	Integrating technology within the lesson plan	An integrated lesson plan for one lecture within their course.

Investigate (Informed by Transfer of Ownership)	Generate an action research idea	Educational Technology Research Methods	Sessions in investigate target basic research methods knowledge of the participants	A mix of instructor guided and participant driven activities.	Identifying innovative ways of using technology and its evaluation strategies.	An Idea Proposal for an action research study
---	----------------------------------	---	---	---	--	---

Table 5.4: Elaboration of format of activities in A2I2 Model

Activity	Examples	Role of Participant	Duration
Instructor Driven (In)	Instructor presenting the content to the participants. Instructor summarizing the content to participant	Learner	Between 5~15 minutes.
Participant Driven Individual (PIn)	Participant writing examples in worksheets meant for pairwise alignment. Participant performing a microteaching activity with visualizations.	Teacher	Between 5~10 minutes.
Participant Driven Collaborative (PCo)	Participants collaborating to write a lesson plan for a single lecture. Participants involved in Think-Pair-Share activity for aligning instructional strategies with learning outcomes.	Shuttles between Learner and Teacher	Maximum of 45 minutes.

5.6 Operationalization of Design Principles during Implementation

5.6.1 Implementation of Immersivity in Training

We implemented Immersivity by:

- Designing sessions in which participants first approach the strategy as a student and then as teachers. For example, we first conducted Peer Instruction strategy within our sessions where participants experienced the strategy as students. Later within the Peer Instruction Lab they created peer instruction questions for their own students.
- Ensuring participants perform a concentrated activity using technology before learning about technology. For example, participants first performed concentrated activities on wiki from asynchronous phase before learning about wikis.

Both these design decisions promoted immersivity because participants become more familiar with these strategies/technology through initial practice before actually trying to create similar strategies for their own classroom.

5.6.2 Implementation of Pertinency in Training

We implemented pertinency by:

- Using extensive examples from the participants' own domains while discussing teaching strategies within the synchronous sessions. For example: for participants from the domain of electrical engineering we had set up examples related to Logic Gates and Ohm's Law across the sessions.
- Asking the participant to work on assignments in a topic they will teach in the coming semester.
- Using extensive examples related to research done on practices/technologies that they learnt during the training while familiarizing them with idea of educational research. E.g. in the idea proposal and study planning stage we had utilized examples of studies done on Think-Pair-Share for explaining key concepts in educational research.

- Asking participants to work on a teaching-learning problem from their own classroom and propose solutions that can be taken up for action research.

These design decisions ensured that participants found the activities within the programme highly relevant for their immediate practice.

5.6.3 Implementation of Transfer of Ownership via Classroom

Action Research

Transfer of ownership is operationalized by exposing participants' to the idea of measuring effectiveness of the implementation. We use the idea proposal template (Murthy & Iyer, 2013) as a scaffold to help participants move from a teacher to a classroom action researcher. The template contains eleven guided questions that will force participants to reflect upon the various aspects of lesson design and identify various metrics of their evaluation.

The subsequent chapters have details about the implementation of the model in three different settings and the results of each of these trainings.

Chapter 6

Implementation of Model – Face to face mode

In this chapter we describe how the A2I2 model was used to design a pilot training programme in face-to-face mode for training engineering college teachers in effective technology integration. As seen in fig 6.1 (below), we use the model to design and implement training in face-to-face mode. The chapter also details the evaluation study undertaken to evaluate the training programme effectiveness and provide us with input about the strategies that worked in current implementation and areas that require improvements. This in turn feeds back to the model and refine it.

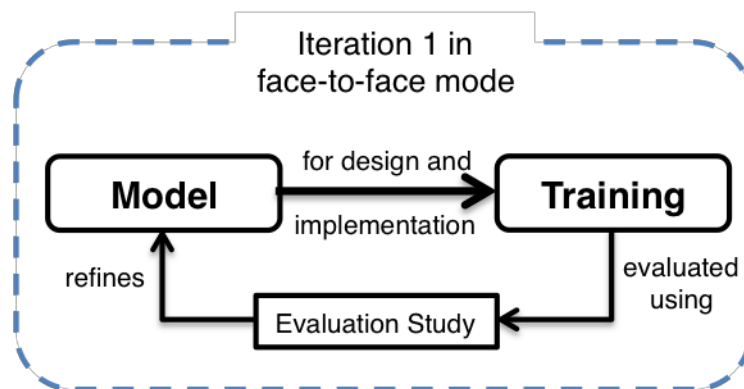

Figure 6.1: Implementation of iteration in DBIR

Since this was a pilot implementation, the focus was on reducing the complexity of the implementation and increasing the clarity of feedback during evaluation. This led to three important design decisions while designing the training programme from the model – (i) focus only on the first three (A2I) phases of the model, (ii) focus only on

the technology of visualization, as this was found to be the most common technology being used by teachers in our context, and (iii) focus on a smaller scale in the face-to-face mode. These design decisions allowed greater control on training content and schedule with reduced dependency on technology available in the training environment.

6.1 Overview of ET4ET₀ (Iteration 1)

ET4ET₀ was designed as a 5-day TPD programme titled “Pedagogy for effective use of ICT in engineering education” and was offered as a ‘Continuing Education Programme’, from June 24 - 28, 2013. The course goal was to train engineering faculty in research based student centric strategies and thus help in constructive alignment, which is found to enable effective technology integration in classroom. The main trainers for this course were the faculty (who were also part of the research team) and research scholars from IDP in Educational Technology, IIT Bombay. These research scholars were also working as college teachers (practitioners), which provided them with a better understanding of the actual situations on the field. The course was targeted for engineering college teachers from the domains of Electrical, Electronics and Computer Science Engineering as well as Engineering Mathematics, as these were the domains of expertise of trainers. A total of 30 participants applied for the course, of which 23 were selected as they satisfied the condition of domain of participants. Out of these 23, 12 were from computer science and allied domains, 7 were from electrical and allied domain, 4 were from mathematics domain.

From exploratory studies (in chapter 4), we have already seen that visualizations (videos/animations/simulations) are the most common technology used by the college teachers in our context. The exploratory studies also showed that teachers had a conception that mere showing of visualization being sufficient for active learning. Thus for iteration 1, we select visualizations as chosen technology for training participants in technology integration. To expose participants to visualizations in lab setting, we had a session on virtual laboratories. Table 6.1 below shows the overall schedule of the training. Since this was the first iteration, the focus was more on training in constructive alignment practices.

Table 6.1: Schedule for training in Iteration 1

Day	Session 1	Session 2	Session 3	Session 4
Day 1	Overview Session	Introduction to Learning outcome (Attain)	Instructional Strategy - What, Why, How? (Attain)	Assessment Strategy - What and How? (Attain)
Day 2	Peer Instruction - What and Why? (Attain)	Taxonomy of Learning outcomes - Lower Level (Attain)	Taxonomy of Assessment Questions - Lower Level (Align)	Peer Instruction - How? (Attain-Align)
Day 3	Think-Pair-Share - What, How, When? (Attain-Align)	Taxonomy of Learning outcomes - Higher Level (Attain)	Taxonomy of Assessment Questions - Higher Level (Align)	Concept Map (Attain-Align)
Day 4	Learning with Visualization (Attain-Align)	Virtual Labs (Attain-Align)	Lesson Design with Visualizations and Presentation (Align)	
Day 5	Open-ended Assessment using Rubric (Attain-Align)	Question Paper Blue Print (Align)	Lesson Planning (Integrate)	

6.2 Research-Practice Partnership in Iteration 1

Starting from the conceptualization of the training, till its implementation, there is a strong collaborative research-practice partnership between researchers and the trainers, who are also practitioners. During the ideation and brainstorming sessions for the design, the trainers brought in valuable insights like the type of technologies used by other teachers, common knowledge gaps existing among practitioners etc. The researchers on their part provided insights on research-based instructional strategies, sequencing of the training content and information on required inputs to inform theory building.

6.3 Implementation of Model in the Iteration 1

Table 6.2 & 6.3 shows the implementation of the model to design the training programme for Iteration 1. This iteration uses the A2I phases of the model.

Table 6.2: Features of A2I Model for designing training programmes (Iteration 1)

Phase	Focus	Content		Format	Output
		Topic	Level of Knowledge		
Attain	Attains Introduction to concepts	Content related to developing Learning outcomes (LO) Instructional Strategies (IS) Assessment Strategies (AS)	Write phase wise learning outcomes that focus on concept attainment.	Majority are instructor led activity	Identification of an LO, IS and AS
Align	Align learnt modules pairwise with deeper knowledge		Write phase-wise learning outcomes that will help participants align learning in modules pairwise.	Majority are participant driven individual activity	Examples of pairwise aligned modules in their course.
Integrate	Integrate the knowledge gained		Write phase learning outcomes that will help participants integrate learning from the modules	Most of the activities are participant driven collaborative	An integrated lesson plan for one lecture within their course.

Table 6.3: Format of activities in A2I model (Iteration 1_{2f})

Activity	Examples	Role of Participant	Duration
Instructor Driven (In)	Instructor presenting the content to the participants. Instructor summarizing the content to participant	Learner	Between 5-15 minutes
Participant Driven Individual (PIn)	Participant writing examples in worksheets meant for pairwise alignment. Participant performing a microteaching activity with visualizations.	Teacher	Between 5-10 minutes
Participant Driven Collaborative (PCo)	Participants collaborating to write a lesson plan for a single lecture. Participants involved in Think-Pair-Share activity for aligning instructional strategies with learning outcomes.	Shuttles between learner and teacher	Maximum of 45 minutes

6.3.1 Catering to participant diversity

To cater to the problem of having a diverse audience, we have done the following:

- Using extensive examples from the participants' own domains while taking different contents within the session. For example, while discussing about creation of learning outcomes using Bloom's

taxonomy, participants were provided with examples from topic of 'Logic Gates' (common to all the participants) and 'Introductory Computer Programming' which is familiar to participants from computer science (see Figure 6.2)

Examples of LO at Level2

- Student will able to *write truth table for given combination of "AND" gates .*
- Expected *answer-table showing various combinations of input and output for given combination of "AND" gates*
- Student will able to *write code in c/java to initialize an integer type array with a specified number of elements*
- *Expected Answer- syntax of integer type array declaration in c/java*
- *(int a[20]- a is integer type array with 20 elements)*

Figure 6.2: Content of slides for session on 'Learning outcomes' designed for catering to diversity
Asking the participant to work on assignments in a topic they will teach in the coming semester. For example,

- Figure 6.3 shows the submissions by two participants from computer and electrical domains for the assignment related to writing assessment questions at higher order levels in Bloom's taxonomy.

WORKSHEET 3.B.2

in the space provided
answers are concise to fill the space provided.
please take help of Workshop TA's

BLOOM'S LEVEL	ASSESSMENT QUESTION
ANALYZE	Find the route of IP packets for a given routing table, given topology.
EVALUATE	Compare class A & class B on the basis of no. of host-id & subnet mask.
CREATE	Design a n/w for college having 5 dept. with class-C IP addresses. Each dept. has 20 IP address & connection to be given.

IOP in Educational Technology

WORKSHEET 3.B.2

your name in the space provided
all your answers are concise to fill the space provided.
please take help of Workshop TA's

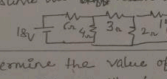
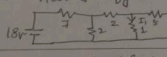
BLOOM'S LEVEL	ASSESSMENT QUESTION
ANALYZE	Analyze the given circuit and find current & power consumed in 4Ω resistor is changed to 7Ω . 
EVALUATE	Determine the value of I_1 using any suitable theorem. Also justify for the chosen theorem. 
CREATE	Synthesize an electrical network for given of Input impedance, Output impedance, transfer impedance etc..

IOP in Education

Assessment Questions written by participant for the topic on Networks (Computer Science domain)

Assessment Questions written by participant for the topic on Network Analysis (Electrical domain)

Figure 6.3: Implementation of Pertinency in creation of assignments

6.3.2 Catering to participants' unfamiliarity with active learning

To ensure that participants' are not overwhelmed or daunted by the active learning strategies, we use the following steps:

- Step 1: Participants experience the instructional strategy as a learner first. For example, in the case of active learning strategy of peer instruction, participants are provided with opportunities of peer instruction during the training while going through initial sessions (say on learning outcomes)
- Step 2: Participants are now explained about the peer instruction strategy in detail
- Step 3: Participants are asked to create peer instruction strategy in their own course

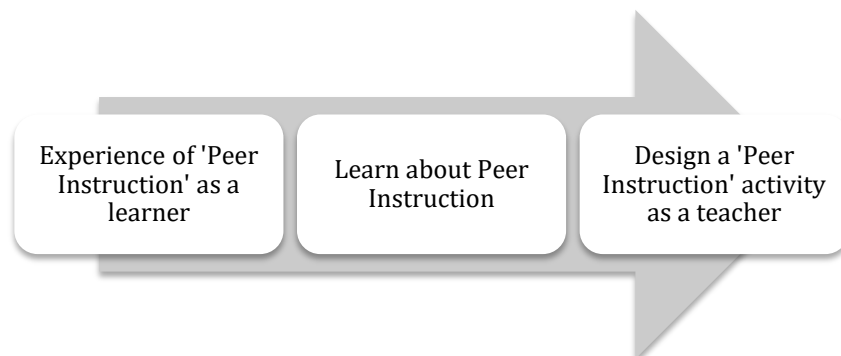

Figure 6.4: Applying design principle of Immersivity to train teachers in Peer Instruction strategy

6.4 Research Study 1

In this iteration, we have used the initial version of the model to create a training programme for technology integration. Using the DBIR methodology, we follow the implementation of the training programme with an evaluation study to identify effectiveness of the training programme (see Figure 6.1). The results on training effectiveness help us in validating the model and provide inputs to refine it further. Since the workshop was done in face-to-face mode, the evaluation study used the

Kirkpatrick's levels of *reaction* and *learning* that could be gathered during the training itself

6.4.1 Research Questions

RQ1.1. What are the perceived changes in teaching practices as a result of the workshop?

RQ1.2. How did the participants perform in the alignment and integration of modules?

6.4.2 Sample

We consider the sample of 21 participants, from the domain of Computer Science, Electrical and Mathematics, who responded to the end of course survey and participated in the focus group discussion.

6.4.3 Data Sources and Instruments

We have used an end of training questionnaire survey and focus group discussions to capture the participant perceptions about the various aspects of the training. We have used the lesson plans and technology integration worksheets to capture the participants' learning from the training.

The end of training questionnaire survey consisted of 24 questions divided into three sections - Usefulness, Learning and Application, and was administered at the end of the workshop. The learning section had questions like "I understood how to align the assessment question to the Learning outcome" to capture perception on participant learning. The application section is designed to capture the perceived changes in the Behaviour within the classroom post-workshop. E.g., a question like "I intend to explicitly specify Learning outcome for my class." The detailed survey questionnaire is provided in Appendix G.

There were 3 focus group discussions, one each with the group of participants within the Electrical & Electronics, Computer Science and Mathematics domains. These discussions were conducted at the end of the workshop. The teaching assistants for the training conducted the focus group discussions. The questions within the focus

group discussions that were analysed to answer the research questions were: “What is the most important takeaway from this programme?” and “Are you confident of applying the learning?” The answers helped us to analyze how much the participants were able to understand the need for constructive alignment within their teaching-learning environment. This also helped in triangulation of their learning on alignment in each of the modules. The second question directly looked at the change in behaviour of participants post-workshop.

The evaluation also utilized lesson plan created in the integrate phase and technology integration worksheet created in the align phase. We analysed the data of all participants who had submitted their worksheet using a custom evaluation rubric. The rubric consisted of 6 dimensions and 4 scales. A sample element of the rubric is shown in Table 6.4. The detailed rubric is provided in Appendix G.

Table 6.4: Sample Rubric element for evaluation of lesson plans

Scale/Dimension	Alignment of Instructional Strategy with Learning outcome
Adequate	The instructional strategy is aligned to the level of learning outcome and all the activities performed by students are mentioned clearly. E.g. In the Pair phase, the students discuss each other's modules to come up with an integrated module for share phase.
Needs Improvement	The Instructional Strategy has been aligned with the Learning outcome however it does not mention clearly what students will do E.g. In TPS for the create level LO, the student activity fails to mention that students discuss various modules with each other in pair/share phase.
Inadequate	The Instructional strategy does not align with the Learning outcome E.g. For create level objective of writing a code to achieve a functionality, the TPS activity makes student debug a program.
Missing	No attempt is made to align the Instructional Strategy with LO

6.4.4 Procedure

The end of training survey was administered using pen and paper. Each participant were provided with the survey form which they had to fill and return. To execute the focus group discussion, the teaching assistants were provided with two clear roles – FGD moderator and note taker. Each of the focus group discussions were audio recorded, transcribed and then analysed. Two raters were trained for the evaluation of lesson plans and the rubric had substantial inter-rater reliability ($k=0.7$) for two raters, after training.

6.4.5 Results

Result 1.1: Participants perceive high learning and are keen on applying the student centered strategies that they learnt during the training

From the survey results shown in Figure 6.5, Figure 6.6 and Figure 6.7, we see that there is an overall high perception of usefulness of the training content, learning within the training and intention to apply among the participants.

The content related to learning outcomes and instructional strategies of Think-Pair-Share and Peer Instruction) had the highest positive perceptions of usefulness (Strongly Agree = 66.7%, Agree = 23.3%, see Figure 6.5). Participants' also perceived that learnt most about setting up of learning outcomes (Strongly Agree = 66.67%, Agree = 23.3%) and writing assessment questions for the learning outcomes (Strongly Agree = 57.1%, Agree = 38.1%). The strategies of Think-Pair-Share (Strongly Agree = 42.9%, Agree = 47.6%) and Peer Instruction (Strongly Agree = 33.3%, Agree = 57.1%) also had an overall positive perception (see Figure 6.6) .

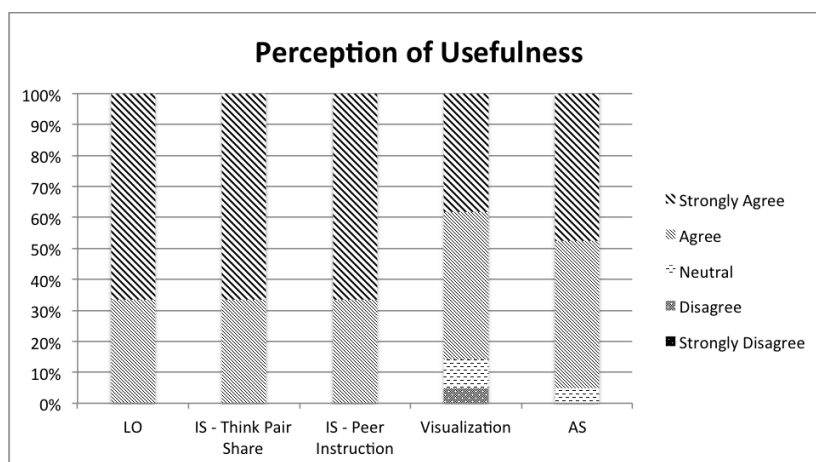

Figure 6.5: Participants' perception of usefulness of training content in ET4ET₀ (N=21)

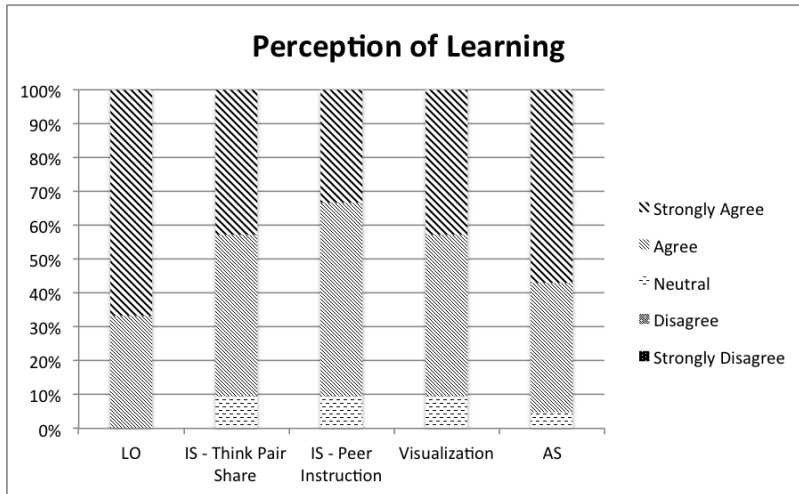

Figure 6.6: Participants' perception of Learning from ET4ET₀ (N=21)

From Figure 6.7 we see that there is also a uniformly high perception of implementing the student centered strategies of Think Pair Share (Strongly Agree = 47.6%, Agree = 38%), Peer Instruction and use of Visualizations (both Strongly Agree = 52.4%, Agree = 33.3%)

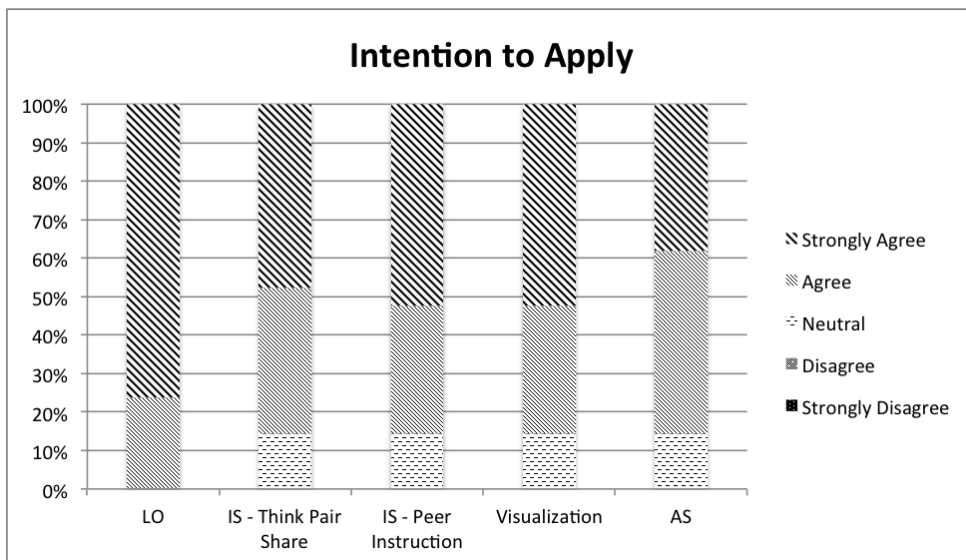

Figure 6.7: Participants' intention to apply the learning from ET4ET₀ (N=21)

Result 1.2: Participants show intention and use Active learning strategies in their final lesson plan.

18 different participants had indicated their intention of using active learning strategies of Think-Pair-Share and Peer Instruction within their classroom. The analysis of the final lesson plans showed that 18 of the participants had also used these active learning strategies. This confirms a clear change in the mindset of the

participants to consciously include student-centered approaches in their teaching-learning practices. Table 6.5 compares the data corresponding to the reported intentions to use strategies and actual use of strategies within the lesson plans. This shift was evident in the responses during the focus group discussions in which one group clearly identified that “[they] have to break the traditional way of teaching so that students can connect”. The discussion also had a larger share of participants opting for Peer Instruction as a possible choice over Think-Pair-Share. All of them had a strong inclination to use ICT in the class in the form of visualizations but required time for practicing the concepts learnt during the training.

Table 6.5: Intention to Use and Actual Use of strategies in lesson plan

Strategy	Think-Pair-Share	Peer-Instruction	Visualization
Intention to use (Actual Use)	12(10)	18(13)	12 (8)

Result 1.3: Participants are able to align Learning outcomes with Instructional strategies more than Assessment strategies.

As seen in Table 6.6, the participants have displayed sufficient mastery in individual modules of Learning outcome and Assessment Strategy with a mean score of 1.95 and 1.76 (out of 3) respectively. The participants are also performing better in the alignment of these two modules with a mean score of 1.76 (out of 3).

Table 6.6: Mean Scores for Alignment in the lesson plans as per the lesson planning rubric (Iteration1)

Module	ATTAIN			ALIGN		
	Learning outcome (LO- 3)	Instructional Strategy (IS – 3)	Assessment Strategy (AS-3)	LO-IS (3)	LO-AS (3)	AS-IS (3)
Mean Score	1.95	1.76	1.19	1.76	1.14	1.19

6.5 Reflections from the implementation

The following were the key reflections from this iteration while moving towards scaling:

- A. In terms of program design
 - a. From results 1.1, we see that there is an overall high perception about the student-centered strategies and from result 1.2 we see that they have shown application of this perception in their lesson plans and

indicate the need to shift to such student-centered practices. This helps us in inferring that A2I model helped in bringing a shift in attitude towards student-centric learning practices.

- b. From results 1.2, we observe that the modules related to alignment between learning outcomes and assessment had lower scores compared to the others. This provides us an insight that the design of this module needs to be refined further to make the learning comparable with the others.

B. In terms of program implementation

- a. During the focus group discussions, participants were unanimous about the need for time for practice to improve their learning (results 1.2). In the current training, the microteaching sessions and align phase activities were earmarked as sessions for practice. However the feedback necessitates us to refine the implementation to factor more time for practice.
- b. Visualization as a technology tools was familiar to the participants, and most of them used it during regular practice that reduced challenges related to searching and selection. While including more technology tools, it should ensured that these technologies do not pose challenge of searching and selection.
- c. During this implementation, we had used the support of the teaching assistants (TAs) to provide assistance to the participants whenever they faced difficulties or had queries. Thus while scaling up since use of TAs will not be a feasible strategy, appropriate scaffolding mechanisms have to be devised that can substitute one-on-one feedback of TA's.

Chapter 7

Implementation of Model – Blended Online Mode

The pilot implementation of the training and the positive evaluations discussed in previous chapter indicated the usefulness of the model in designing TPD programmes for effective technology integration. However our research goal requires the need for the model to be scalable so as to cater to the context of Indian engineering education. For scaling the access to training, we utilize the training platform created by the Train 10,000 Teachers (T10kT, 2012) project.

T10kT is an outreach project of IIT Bombay under National Mission on Education through ICT (NMEICT), initiated by Government of India, which focus on improving teaching skills of faculty in core engineering and science subjects. The project utilizes the network with engineering institutes identified as remote centers for scaling of TPD efforts in engineering education (Atrey et. al., 2016). The training environment in T10kT facilitates synchronous interaction between a central hub and different spokes (also called synchronous remote centers or SRC) through live virtual classroom software A-VIEW (Anand et. al., 2014). The interactions at the SRC's are mediated through remote center coordinator (RCC), who is a faculty from the remote center. The RCC uses the chat and question features available in A-VIEW to interact with the instructor who is sitting at the hub. The training environment also has the

learning management system MOODLE that facilitates asynchronous interactions among participants through discussion forums. The T10kT had a total of 353 established remote centers by 2013. Figure 7.1 (see below) gives an overview of this training environment.

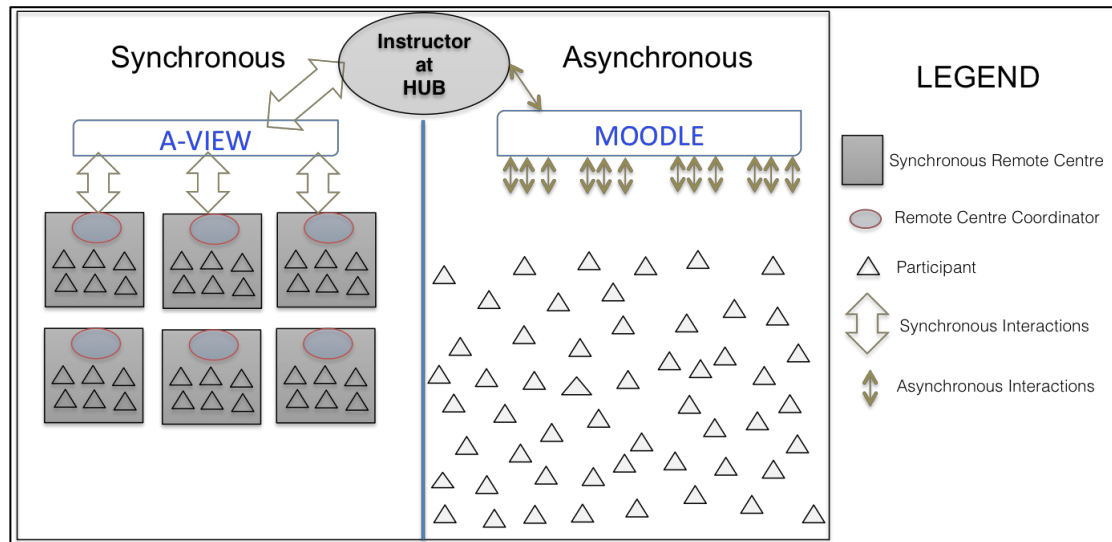

Figure 7.1: Training environment provided by T10kT

Thus in this chapter, we explain the use of A2I2 model for scaling up TPD programmes for effective technology integration and evaluate the effectiveness of these trainings to validate the model. In line with DBIR approach used throughout this thesis, we have used the design-implement-evaluate-refine cycle to design three training programmes – ET4ET₁, ET4ET₂ and ET4ET₃ (see Figure 7.2). The evaluations help in refining the model and thus generate 4 models, Model₁ – Model₄, across the entire implementation in blended mode.

The chapter is organized as follows. In section 7.1, we describe the design decisions taken in this mode regarding the choice of technology (7.1.1) and pedagogical modifications for blended learning mode (7.1.2). Specifically we explain how we adapted the active learning strategies in this mode, by making use of the training environment features. The implementation and evaluation of the trainings ET4ET₁ – ET4ET₃ are then described in sections 7.2 – 7.4. Section 7.5 provides the overall reflections from all the blended mode implementations. Table 7.1 shows the organization of the research studies across this chapter, along with the evaluation parameters used in each research study.

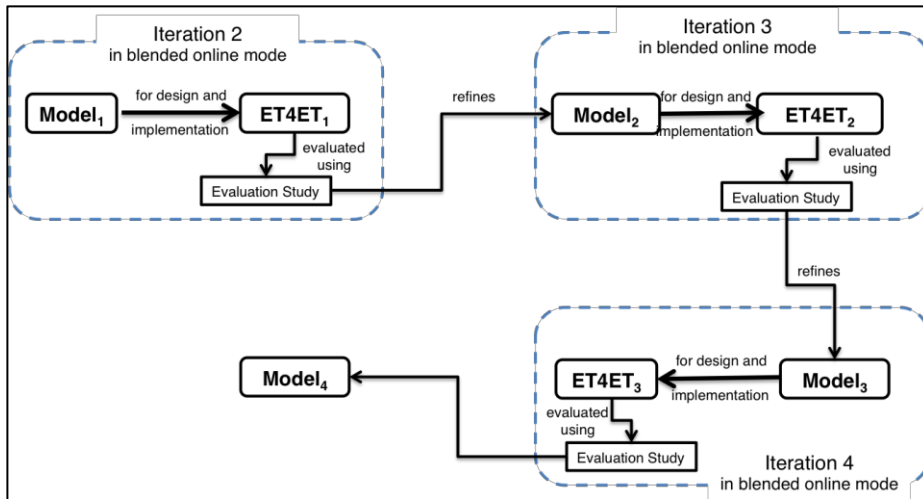

Figure 7.2: Iterations of training in the blended learning mode

Table 7.1: Organization of research studies across this chapter

Training	Iteration 2 (ET4ET ₁)	Iteration 3 (ET4ET ₂)	Iteration 4 (ET4ET ₃)
Relevant Section	7.2	7.3	7.4
Model being used	Model ₁	Model ₂	Model ₃
Technology Trained on	Wiki, Screencast, Visualization	Wiki, Screencast, Visualization	Wiki, Padlet
Evaluation Study	Research Study 1	Research Study 2	Research Study 4
Evaluation Parameters	Persistence Perception	Persistence Perception Learning Behaviour	Sustainability

7.1 Design decisions taken in this mode

While scaling up from the face-to-face to the blended online mode, as training designers we had to take design decisions on choice of technologies for training, modifications required in the blended learning environment, adaptations for pedagogic strategies in the blended learning environment and creation of scaffolds for participants to assist them in learning artefact creation. Since these design decisions directly affect the training design and implementation, the evaluation of the training will also provide feedbacks about these design decisions as well.

7.1.1 Choice of technology for training

From the implication of exploratory studies, discussed in section 4.3, we see that participating teachers in our context primarily rely on presentation tools (like visualizations) and are not fully utilizing the features of technology to make the learning student-centered. Thus introduction of a new technology would have to be carefully thought of so as to avoid complications due to steep learning curve of technology.

To select the appropriate technologies, we additionally look at the affordances within the learning environment and match the technologies that can be integrated within it. The blended learning environment uses video streaming functionality of A-VIEW for synchronously interacting with the instructor. It also uses the learning management system MOODLE both as a repository of training resources and to generate asynchronous discussions via discussion forum. Thus we get the following list after shortlisting the features technology available within the blended training environment, – video watching and synchronous interaction through chat, content management, asynchronous discussion and collaboration through discussion forums and learning management system. Thus we get the following list of candidate technologies that can be integrated in this environment - Screencasts for creating video contents, conferencing softwares like Google Hangout or Skype for synchronous interactions, Content management system like Drupal, Wordpress etc., wikis for both content management and asynchronous collaboration, MOODLE for learning management.

To select the appropriate technologies from this, we look at the utility of technology in the participants' context, learning curve for technology and need for taking an optimal number. In the Indian operating context, we have more focus on instructor-mediated classrooms. Though there is Internet access within each participating institution, not many have introduced it inside classrooms. This will seriously limit the use of synchronous communication tools like Skype or Hangout. Additionally, though participants are exposed to MOODLE during the training, not all institutions are using this learning management system for their academic purposes. This makes MOODLE a non-desirable technology. The content management system like Drupal and Wordpress are associated with steep learning curves if we are to extensively use them. A simple wiki with WYSIWYG editor would take care of both content

management and asynchronous communications. Thus we freeze the candidate technologies for blended learning environments as – Screencast, wikis and visualizations. Within wikis we utilize Wikispaces, as it provided a simpler WYSIWYG editor with better options for project management inside the wiki.

7.1.2 Modifications in the blended learning environment

The blended learning environment used in T10KT project has already been discussed in Figure 7.1. Since wikis were a chosen technology in the blended mode, we have integrated Wikispaces with the existing learning environment as shown in Figure 7.3. Participants were provided with an entry code for registering with the wiki on the first day itself, and they were provided with clear instructions on the process required to register in the wiki.

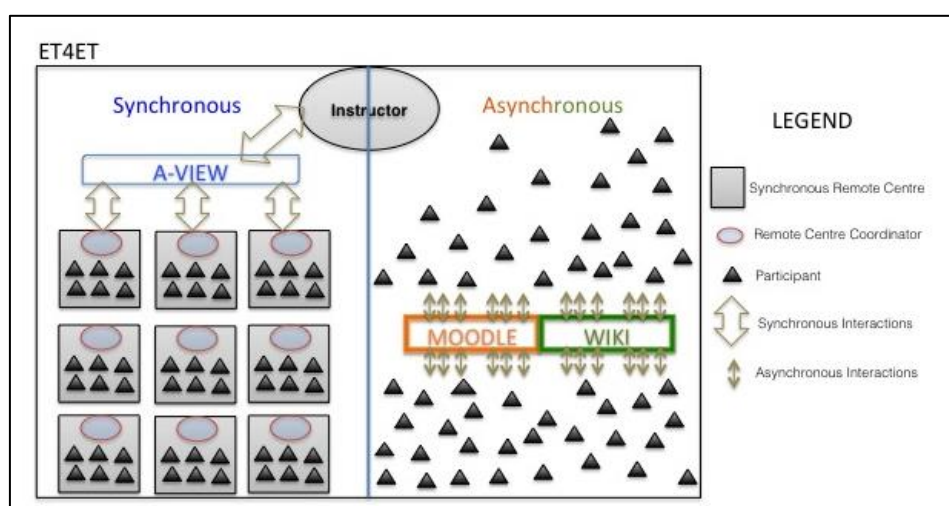

Figure 7.3: Modification made in T10kT training environment for ET4ET

7.1.3 Model for adapting active learning strategies in Blended online mode

The recommendations for effective TPD mentions the need for instructors to be exposed to active learning during the training itself (Desmione, 2009; Guskey & Yoon, 2009). A2I2 model, with its theoretical basis on constructive alignment, also recommends use of active learning while developing training programmes based on it. Thus it is important for us to look into possibilities of implementing active learning strategies while scaling up using the blended learning environment provided.

Since the SRC mode is an instance of distance education mode, a major challenge will be to reduce transactional distance, identified as “a psychological and communications gap” (Moore, 2007) that is created in part due to physical distance between learner and instructor. Distance education research unanimous about focusing on maintaining sustained learner interactions to reduce the effects of transactional distance (Bernard et. al., 2009; Jaffe, 1997). The SRC mode combines some features of synchronous delivery mode, with others of f2f classrooms, but it does not incorporate *all* necessary features to directly implement practices from either mode. Hence the need is to have a model of adaptation of active learning strategies, considering the affordances and constraints of the SRC mode.

The key interactions or transactions in an educational environment happen between instructor (I), student (S) and content (C) (Shale and Garrison, 1990). When I examine the active learning strategies, these interactions can be classified into three levels – student-content (S-C), student-student (S-S) and student-instructor (S-I). Thus while adapting active learning strategies in SRC mode, I will have to adapt these interactions using the affordances provided by the SRC environment viz. Feature of chat in A-VIEW and mediation by Remote Center Coordinator (RCC). The S-C and S-S interactions do not have major changes in the SRC mode, but the S-I interaction has to be adapted to counter the transactional distance. Figure 7.4 shows a model for adaptation of these strategies in an SRC mode.

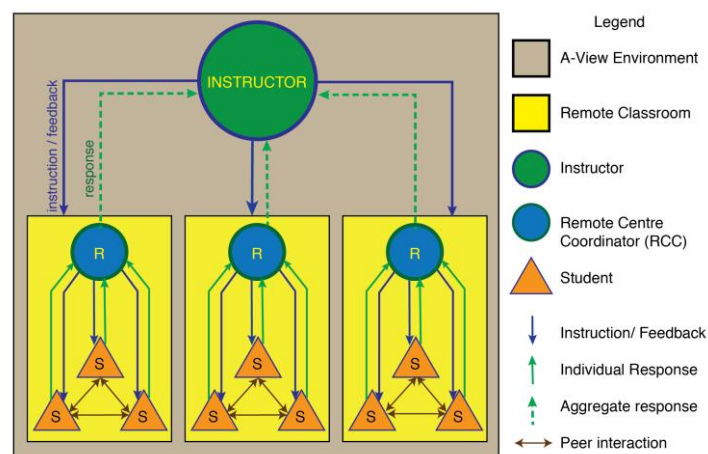

Figure 7.4: Model for adapting active learning strategy in blended online mode

S-I interactions can be categorized into three types: (i) Instructor directives, in which the instructor gives directions to students for performing an activity, (ii) Student responses, in which students respond to the instructor after completing the activity, and (iii) Discussion/Feedback in which the instructor gives feedback on students' responses and discusses the topic. In an SRC mode, instructor directives are adapted by having the RCC play the role of proxy instructor within the local SRC and relaying the directives to the students (downward blue arrows in Figure 7.4). Student responses are adapted by having the RCC play the role of proxy instructor to aggregate the responses and the role of information transfer agent to send the aggregated response to the instructor (upward green arrows in Figure 7.4). Discussions and feedback are adapted as a combination of the above. Technology plays the role of facilitating information transfer (Grey background in Figure 7.4).

These adaptations can be better understood with two examples of their usage within the training.

Adaptation of active learning strategy of Think-Pair-Share

First we see how the active learning strategy of Think-Pair-Share (Lyman, 1981) (TPS) has been adapted within the SRC mode. The general active learning strategy of TPS is marked by three different phases as the name suggests, each of which is preceded with an instructor directive to move to that particular phase.

- Think Phase
 - In face-to-face classroom, Instructor poses a question and directs students to initiate the Think phase. During this phase students are engaged with the content.
 - In SRC mode, the instructor poses a question and provides a directive to the remote center to initiate the Think phase. The RCC plays the role of information transfer agent to convey the instructor's directives to the participants (downward blue arrows from R to S in Figure 7.4). During this phase participants are engaged with the content
- Pair Phase
 - In face-to-face classroom, a fresh cue is given by the instructor to move to Pair phase upon which there will be student-student interaction along with the existing student-content interaction.

- In SRC mode, the RCC performs the role of proxy instructor to ensure student-student interaction (horizontal brown arrows in Figure 7.4) happens in the pair phase.
- Share Phase
 - In face-to-face classroom, next instructor cue to share the results adds the student-instructor interaction dimension to the process. This is culminated by the general feedback provided by instructor on the shared result.
 - In SRC mode, the RCC performs the role of proxy instructor to collect student responses and aggregate them, and the role of information transfer agent to convey the aggregated response to the instructor for subsequent discussion (upward green arrows in Figure 7.4). The instructor now gives a general feedback to remote centers (downward blue arrow, like in Think Phase)

We note that the actions in each phase of the TPS in our adaptation remain the same as those in a single face-to-face classroom. Hence despite an increase in the physical distance between the learners and the instructor, our model of adapting AL strategies to SRC mode helps mitigate the transactional distance. Similarly, other active learning strategies could be adapted in the SRC mode.

The Synchronous Remote Center (SRC) mode of delivery available in such blended training programmes can be thought of as an elongation of regular classroom with two mediating variables playing a crucial role – Technology and Remote Center Coordinator (RCC). The role of technology is that of information transfer through the audio-video conferencing capability and chat module available within A-VIEW. The RCC plays dual role of proxy instructor as well as information transmitter. As seen from Figure 7.2, the general active learning strategy in f2f when adapted to this blended mode works in a similar fashion with the distinction coming in terms of the elongation of S-I interaction chain. The posing of problem, directives and feedback from instructor still exists with the difference that the RCC executes the directives as a proxy instructor in his local center. Also in terms of student response to instructor, RCC aggregates the student responses within his local center and transfers it to instructor via the chat module present in the A-VIEW.

7.1.4 Scaffolds for assisting participants during creation of artefacts

An implementation goal for this training was to provide a scaffold in place of TA's so that participants get adequate support during creation of learning artefacts. Our solution to this was creation of 'activity constructors'. Activity constructors are resources that assist you in creation of learning artefacts. An activity constructor has the following structure: 'General Instructions', 'Guiding Questions' for artefact creation, 'Guiding Tips' for artefact creation, 'Space for Artefact Creation' and an 'Instructor Created Example' for the learning artefact. For example, a portion of the 'Think-Pair-Share activity constructor' for creating Think-Pair-Share strategies is shown below.

The screenshot shows a web-based form titled "Indian Institute of Technology Bombay" and "IDP in Educational Technology". The form is for "Instructor Resources" and is titled "Resource - Think-Pair-Share Activity constructor". It includes a download link and a license notice. The main content is "Part 1 - Plan your TPS activity" with three numbered steps. Step 1 is a general instruction. Step 2 is a guiding question. Step 3 is a guiding tip with an example. Below the steps is a text box for writing a question. Red annotations with arrows point to these elements: "GENERAL INSTRUCTION" points to step 1, "GUIDING QUESTION" points to step 2, "GUIDING TIPS" points to step 3, "INSTRUCTOR CREATED EXAMPLE" points to the example text in step 3, and "SPACE FOR ARTEFACT CREATION" points to the text box at the bottom.

Indian Institute of Technology Bombay
IDP in Educational Technology
Instructor Resources

Resource - Think-Pair-Share Activity constructor
Version 1.0, Dec 2013
Download from: www.et.iitb.ac.in/TeachingStrategies.html
Released under: Creative Commons-Attribution 4.0 license

Part 1 - Plan your TPS activity

1. → Choose a topic from your current/next course that has scope for multiple solution approaches, or detailing of an abstract concept, or some form of open-ended discussion. See Appendix for some examples. **GENERAL INSTRUCTION**
2. → Identify the broad category of problem that you are attempting within the TPS - <Write category here> **GUIDING QUESTION**
3. → Think phase: Write an initial (seed) question on the problem or topic you want to discuss. **GUIDING TIPS**
Example from cs101: "Write the pseudo-code to find the smallest element in an integer array".
Ensure that: (i) The question is broad enough so that most students in your class can write some response. (ii) A student can think about it and write an individual answer in about 1-3 minutes. (iii) There is a clear deliverable for the student. **INSTRUCTOR CREATED EXAMPLE**

Write your Think phase question here: **SPACE FOR ARTEFACT CREATION**

Figure 7.5: Think-Pair-Share Activity Constructor, showing portions relevant to think phase. Similar constructors have been created for Peer Instruction activity design, Screencast creation, Flipped Classroom activity design, Visualization selection, Wiki activity design and Lesson Planning. These are available in Appendix B.

7.2 Iteration 2

7.2.1 Overview of the training - ET4ET₁

The first training in the blended mode, called ET4ET₁, was scheduled from Jun 12 – Aug 2, 2014. The training was conducted as part of Quality Enhancement in Engineering Education (QEEE) certificate programme. 1138 teachers attended this training from 38 different remote centers. The participants were from diverse domains of Engineering (Electrical, Mechanical, Civil, Computer Science etc), Basic Sciences and Management. The training program was conducted across a total time span of 7 weeks to ensure that participants obtained sufficient time for practice. The certification criterion for the training was submission of 6 out of 16 assignments.

The program began with 3 days of sessions in the Synchronous Remote Classroom (SRC) mode, followed by 5 weeks of asynchronous Moodle-based interactions (considered to be equivalent to 5 days of synchronous sessions) and concluded with 3 days of synchronous sessions where participants reassembled at their remote centers as the first 3 days. Each day in the synchronous mode contained four sessions (each of 1.5 hour duration), each of which dealt with one of the three core modules or their alignment. Each asynchronous session spanned a week. Figure 7.5 shows the detailed schedule of the training along with mapping of appropriate phases of A2I2 against

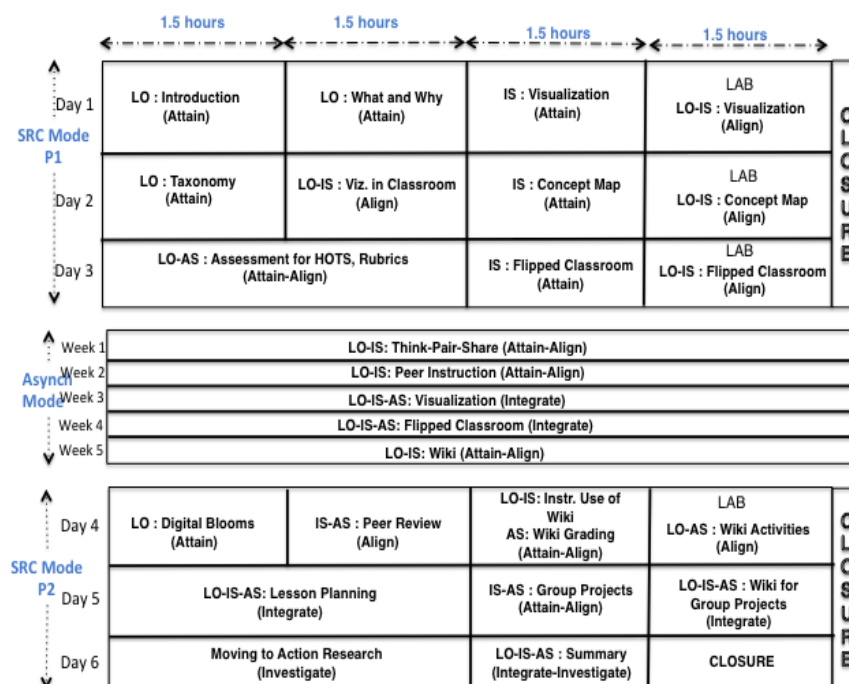

Figure 7.6: Training schedule for Iteration 2_{bo}

training content.

7.2.2 Applying the model in a new setting

Going from small to large-scale implementation, the key design decisions prescribed by the A2I2 model stayed the same, but the implementation was adapted to account for the scaling, both in terms of the number of participants and the duration of the program. The training program design not only took into account the scale, but also took advantage of the affordances of the ICT-enabled mode of implementation: the SRC mode provided by the T10KT project infrastructure, combined with the asynchronous interaction via Moodle. Though there was an investigate phase, it was not followed up in the current iteration

While scaling up the training, the following were the main design decisions:

- a) The three core modules of learning outcome, instructional strategy and assessment strategy remained the same.
- b) Since the duration of ET4ET' workshop was longer than the pilot, more content was added. A larger number of ICT tools addressing different teaching-learning goals, and corresponding instructional strategies were discussed.
- c) The active learning pedagogy stayed the same, however this got adapted to the SRC mode of implementation.
- d) To cater to diverse audience, in terms of domain, use the same strategy of creating examples from multiple domain
- e) Focus was given more on implementation and evaluation of the first three phases, Attain-Align-Integrate.
- f) Though there was an investigate phase, focus was not on its outcome, rather execution.

Implementation in Individual Session

We take the example of the initial session “Learning outcome – What and Why?” for explaining the implementation of A2I model for an individual session.

Table 7.2: Design of an individual session using A2I Model

Phase	Focus	Content		Format	Output
		Topic	Level of Knowledge		
Attain	Introduction to concept of Learning outcomes.	What is Learning outcome? Why Learning outcome?	Explain need for Learning outcome. Distinguish between appropriate and inappropriate Learning outcome.	An entire session of 30 min with a majority of instructor driven activities (concept introduction) and a few participant driven activities (like Think-Pair-Share) interspersed between them.	Identification of an appropriate Learning outcome for participant's own course.

Implementation in whole workshop

The Table 7.3 shows A2I2 model being used to design training modules for the technology tool –Wiki, in Iteration 2_{bo}.

Table 7.3: Design of an entire technology integration training using A2I model

Phase	Focus	Session		Format	Output
		Topic	Level of Knowledge		
Attain	Introduction to wiki	Wiki – What and Why?	Explain instructional purposes of wikis. Identify technical features of a wiki like access permissions, members, file upload etc.	Since, this topic was done asynchronously using Moodle, we used the Lesson Module to provide content (In) and short questions at Recall/Understand (Pin). There were Slides (In) and Quizzes (Pin) to ensure that participants complete attain phase.	Explore existing wikis to identify their instructional use Identification of a possible use of wiki in their own course.
	Evaluation of a wiki	Wiki Grading Rubric	Identify possible elements of a wiki which can be evaluated Identify measures for each element.	This topic was done synchronously and was more a lecture delivery with slides (In). The duration of session was 10 minutes.	Identifying evaluation parameters of the wiki created for own course.
Align	Depth in Concepts and Intro to Alignment	Instructional use of Wiki in Engineering Courses	Create an instructional plan for implementing wiki in their course.	Participants were filling the wiki planning constructor individually based on the objectives and evaluations that they identified in the attain phase.	An implementation plan for a wiki based strategy in individual course.
Integrate	Lesson Planning using Wiki	Wiki for Group Projects	Create a lesson plan that integrates Wiki for conducting Group Projects	This topic was done as a separate lab session during synchronous sessions. Participants were provided with the specific context of use of wiki for group projects. They were encouraged to collaborate and develop a wiki integration plan for carrying out student group projects.	Wiki plan for facilitating student group projects.

7.2.3 Research Study 2 – Effectiveness of ET4ET₁

A major metric used for measuring effectiveness of large-scale programmes is either the completion rate or dropout rates (Yang, Sinha, Adamson, & Rose, 2013). In many of the programmes, it is seen that as the course progresses, the attrition increases and finally the completion rates are as low as 6% (Jordan, 2011). Academicians have coined this as the funnel of participation (Clow, 2013) and have mentioned that funneling occurs right from awareness till the completion.

Before explaining the study, the following definitions need to be remembered to understand the funneling process in ET4ET training.

- (a) **Registered Participants** – Total Number of participants who registered for the program
- (b) **Active Participants** – Total number of participants who participated in at least one activity (either in an SRC session or submitted an assignment).
- (c) **Certified Participants** – The number of participants who were present in SRC for all the sessions and satisfied certification criteria of assignments.
- (d) **Completion Rate** – The ratio of number of participants who completed all the activities to the number of registered participants.
- (e) **Drop out rate** – Ratio of total number of participants who registered for the course but did not complete it.
- (f) **Persistence rate** – The ratio of number of participants who completed all the activities to the number of active participants.

We had introduced technologies of wiki and screencast apart from visualization in ET4ET₁, and had developed training modules based on the A2I model adapted to the blended online mode (Model₁). The wiki module was done in a blended mode comprising of fully online initial phase (Attain) and SRC mode for second phase (Align). Based on the broad research questions related to effectiveness of the training programme, this evaluation study was undertaken to answer the following research questions:

Research Questions

RQ 2.1: What is the completion rate and persistence rate for ET4ET₁ training developed from A2I2 Model₁?

RQ2.2: What is the perception among the participants on their use of wiki, screencast and visualization in their own practice after the ET4ET₁ training?

RQ 2.3: What impact does the ET4ET₁ training have the perception of competence in design, implementation and evaluation of wiki-based activities among the participants?

Sample

The total number of registered participants for the training was 1138 (from 38 different colleges). Out of them 914 had attended on the first day and 291 attended on the final day. For calculating the completion and persistence rates, we have used the total registrations and the number of attendees on the first day. To calculate the perception of wiki use, we have taken the sample size as 178, which is the number of respondents to the end of course survey and who have provided informed consent. To calculate perception of competence, we use the responses from 129 participants who responded to the Technology Competence survey administered at the end of integrate phase.

Data Source and Instruments

To calculate the completion and persistence rates, we have used the attendance records collected from each remote center and the assignment submission data from Moodle.

Data on participants' perceptions learning from this programme were obtained from a questionnaire survey administered via Moodle at the end of program. The questionnaire had a total of 29 questions. Data from 12 out of the 28 questions, relevant to perception metrics, are shown below. (The remaining questions were related to demographics or organization logistics). 6 questions were on perceptions on learning, for example "I learnt how to set up a wiki-based activity for my course from the sessions on Wiki" and 6 questions were on intention to use in participants' own courses, for example "I plan to use wikis in my course in the coming semesters". The questions were on a 5-point Likert scale ranging from Strongly Disagree to Strongly Agree. Apart from the Likert scale questions, participants were also asked to provide open-ended feedback on the program. Additionally we have administered a questionnaire survey after the align phase ended for wiki (end of intervention for

technology wiki). We have used a questionnaire survey adapted from Technology Proficiency Self Assessment Survey (Milman, Nortecamp & Peters, 2007). The survey questions were asked on “Selection of Technology”, “Use of Technology to design lessons” and “Evaluation of artefacts generated by students using technology”. The survey utilized a four-scale approach - “I cannot do this”, “I need training to this”, “I can do this with support of resources like books/videos etc” “I can do this independently” and “I can teach this to others”.

The cronbach’s alpha for the survey was 0.83 that showed the survey was reliable. To check the validity of survey we did an Exploratory Factor Analysis using Principle Component Analysis with Varimax rotation. The factor analysis had resulted in 2 factors with four elements loading onto each with values greater than 0.6.

Data Analysis Techniques

Completion and persistence rates were directly calculated from the attendance and assignment submission data.

A frequency analysis of the end of training and technology competence survey responses were done to calculate perception of learning and technology competency respectively. The Gamma correlation was used to identify the correlation between questions related to design, application and evaluation of wiki activity.

Results

(a) Result 1: ET4ET₁ has a completion rate of 15.37% and persistence rate of 20.83%

There were 16 assignments in all. While analyzing the assignments we looked at four levels of submissions – participants who submitted one assignment, 6 assignments (~40% of assignments), 12 (75% of assignments) and all 16 (100% of assignments). The details of assignment submissions and corresponding participation rates are analyzed and shown in Table 7.4.

Table 7.4: Frequency of Assignment Submission

Number of submissions	1	6	12	16
Participants who submitted	840 (92%)	550 (60%)	311 (34%)	175 (19%)

Table 7.5: Attendance data of synchronous sessions from the remote centers

SRC Phase	Day 1	Day 2	Day 3	Day 4	Day 5	Day 6
Participants	914	559	617	795	330	291

Upon examining the response to the survey question on when do the participants prefer training programmes like these we obtained results shown below:

Table 7.6: Preferred month for attending training

Month	Jan	Feb	Mar	Apr	May	Jun
Preference	27 (15.2%)	5 (2.8%)	6 (3.4%)	14 (7.9%)	58 (32.6%)	84 (47.1%)
Month	Jul	Aug	Sep	Oct	Nov	Dec
Preference	42 (23.6%)	5 (2.8%)	3 (1.7%)	5 (2.8%)	32 (18%)	60 (33.7%)

(b) Result 2: 73.6% of respondents have positive perceptions of learning wiki, 88.2% of respondents have high perception of learning to design flipped classroom (using screencast) and 89.9% of respondents have high perception of incorporating active learning strategy with visualization

Data on participants' perceptions on learning within a session is shown in Table 7.7. It is seen that only 12.9% of respondents had high positive perceptions of learning wiki while 37% had high positive perception of learning to design flipped classroom (using screencast) and 33.1% had high positive perception of using active learning strategies with visualization. The perception of learning of active learning strategies of Peer Instruction (92.7%) and Think-Pair-Share (92.7%) is slightly higher than the technology counterparts.

Table 7.7: Participants' perception on learning (N=178)

Participant learnt	Strongly Disagree	Disagree	Neutral	Agree	Strongly Agree
Instructional use of Wiki	1	8	38	108	23
Design a flipped classroom	1	6	14	91	66
Incorporate active learning strategy while use visualization	0	4	14	101	59
Set-up a Peer Instruction activity	1	3	9	103	62
Set up a Think-Pair-Share activity	1	5	7	92	73

(c) Result 3: 51.9% of the respondents feel competent to teach using wiki independently while 50.4% of respondents require assistance in designing lessons using wiki for higher order thinking skills (HOTS)

Overall there is a higher perception among participants about their capability to implement and evaluate wiki-based activities individually (51.9% and 48.1%). Around 50% still feel that they would need assistance to design wiki activities for targeting HOTS. When it comes to using wiki for evaluation, 49.6% feel that they will be able to do it individually. Also 43.4% feel that they are capable of guiding students to create rubric for evaluating their own wiki activities. The details of these responses are provided in Table 7.8 below.

Table 7.8: Perception of competence of using wikis (Post intervention survey results, N=129)

Question	I cannot do this	I can do this with some assistance	I can do this independently	I can teach this to others
Finding /selecting wiki	2(1.6%)	63(48.8%)	55(42.6%)	9(7%)
Designing lessons using wiki targeting HOTS	2(1.6%)	65(50.4%)	53(41.1%)	9(7%)
Teach lessons using wiki	6(4.7%)	45(34.9%)	67(51.9%)	11(8.5%)
Use wiki-based strategies for evaluation	3(2.3%)	52(40.3%)	64(49.6%)	10(7.75%)
Evaluate student wiki artefacts	5(3.9%)	55(42.7%)	62(48.1%)	7(5.4%)
Guide students in development of rubric for assessing wiki	9(7%)	53(41.1%)	56(43.4%)	11(8.5%)

(d) Result 4: High positive correlation between perceptions about design, implementation and evaluation.

Result 2 indicates that there is high perception among participants about their learning about wiki. We now look at the correlations between perceptions about competence in design, implementation and evaluation of wiki-based activities. These questions would be indicative of participants' ability to constructively align wiki based lesson after training. The result of the correlation analysis is shown in Table 7.9 below. It is seen that all three perceptions have high γ values, with maximum correlation seen for responses in questions on design and evaluation of wiki based activities.

Table 7.9: Correlation between perceptions of design, implementation and evaluation of wiki

Variables	Design and Teaching	Design and Evaluation	Teaching and Evaluation
Gamma (γ) and P-value	0.58, $p < 0.001$	0.748, $p < 0.001$	0.774, $p < 0.001$

7.2.4 Reflections and Implications of Iteration 2

- Adaptations of active learning strategies in SRC setting can be used to scale A2I2 model.
- The answer to RQ2.1 (Result 2.1) indicates that there is a high attrition when you scale the training programmes. However the persistence rate of 20.83% is comparable with similar large-scale courses (Jordan, 2011).
- From the tables 7.4 and 7.5 in Result 2.1, we see that as the number of days increases there is a significant attrition (330 and 291 out of 1138). Hence extending the duration of TPD to 7 weeks may not have provided the necessary incentive for participants.
- If we look at the Table 7.6, we see that preference for July as a month for professional development was only 23.6%, compared to 47.19% for June. Thus it might have been better if the schedule were limited to the single month of June.
- The answer to RQ 2.2 (Result 2.2) about perception of learning of technologies indicates that wiki is least learnt (73.6%) compared to the technology tools of screencast (88.2%) and visualizations (89.9%). One possible reason for this could have been the fact that participants are familiar with recorded video and visualizations, which would have made the learning curve for both these technologies low. Since wiki is a new technology for many, we need to rethink about the strategies for integrating wiki in the training content. Current strategy of guided information (showing examples first and then exposing to wiki) doesn't seem to work.
- High perceptions in Result 2.2 also suggests that use of asynchronous sessions for the 'Attain-Align' phases of active learning strategies did not have an adverse impact on the perception of learning of these strategies.
- Result 2.3 indicates that designing of lessons targeting higher order thinking skills using wiki still requires assistance. While comparing the implementation strategies of research-based instructional strategies (like Peer Instruction and

Think-Pair-Share) with that of technology, we see that participants are not experiencing features of an unfamiliar technology like wiki as a student first.

7.2.5 Training goals for next iteration

Based on the results and implications seen in 7.2.4, the following training goals were decided:

- A. In terms of training design for a new technology like wiki, try to ensure that participants are exposed to the technology as a student first
- B. In terms of training implementation, reduce the duration between two synchronous sessions, and also try to ensure that blended training gets over in a month.

7.3 Iteration 3

This is the second training in this mode (See Figure 7.6 below). In this we use the refined A2I2 model (Model₂), based on the reflections from Iteration 2, to develop the training programme – ET4ET₂.

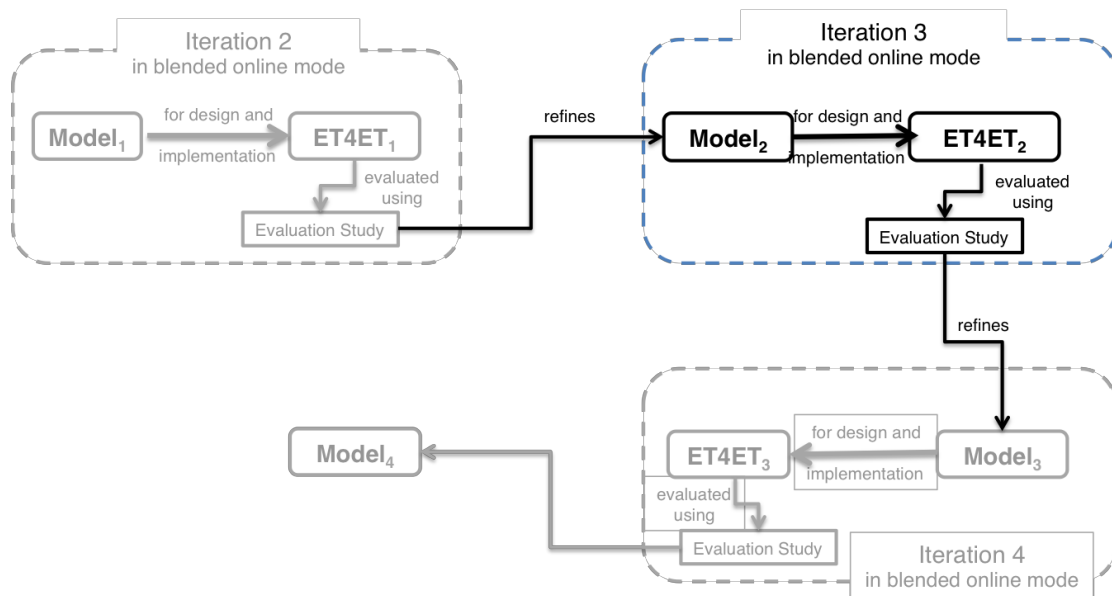

Figure 7.7: Overview of Iteration 3

7.3.1 Overview of the training – ET4ET₂

The second training in the blended mode, called ET4ET₂, was scheduled from Jan 5 – Jan 31, 2015. The training was conducted as an Indian Society for Technical

Education's certified training programme. This training utilized the same platform as the one used in Iteration 2 (A-VIEW, MOODLE and Wikispaces, seen in Figure 7.3) to provide training for faculty in constructive alignment practices. 4358 teachers attended this training programme from 148 different remote centers across the country. The participants were from diverse domains of Engineering and Basic Sciences. The training now spanned only 4 weeks and consisted of only 12 days in between two synchronous sessions and another 10 days post the final synchronous session to ensure that participants get sufficient time for practice without losing interest. Participants had to submit 8 out of 16 assignments to obtain the certificate.

Each day of a synchronous session consisted of a total 4 sessions followed by a closure at the day end, where participants from each remote center are provided with opportunity to interact with instructors for clarifying queries (see Figure 7.8 below). In the synchronous phase, participants worked through in a number of active learning strategies such as Peer Instruction and Think-Pair-Share conducted via A-VIEW. They also learnt how to use technology-based teaching-learning strategies such as flipped classroom using screencasts and wiki. In the lab and asynchronous sessions they use Moodle and wiki environments. There were 10 A-VIEW sessions and 10 Lab sessions across the training. The participants had to submit 10 key assignments across these sessions to demonstrate their learning. As seen from Figure 7.8, there is a high focus on participant engagement with content through lab sessions during each day of the Phase 1 and Phase 2 of the workshop.

	Session I 1.5 hours	Session II 1.5 hours	Session III 1.5 hours	Session IV 1.5 hours	
Day 1 Sync. Mode P1	Introduction	LO-What and Why (Attain)	L A B Attain	Hierarchy of Cognitive Levels (Attain)	C L O S U R E
Day 2	Concept Mapping as a tool for course planning Attain	Digital Blooms (A-VIEW) Attain	L A B Attain	Interactive Visualization for higher order learning (Attain-Align)	
Day 3	Assessment for HOTS, Rubrics (Attain-Align)	LAB - Wiki Attain	Flipped Classroom (Attain-Align)	LAB Peer Instruction (Attain-Align)	
Asynch Mode	Online 1: Wiki Tasks (Attain-Align) Online 2: Assessment (Align) Online 3: Flipped Classroom (Align-Integrate)				
Day 4 Sync. Mode	Feedback	Peer Review (Align)	LAB (Align)	Collaboration through Wiki Align	C L O S U R E
Day 5 P2	Effective Integration of Technology (Integrate)		LAB (Integrate)	Lesson Plan (Integrate)	
Day 6	Planning an Educational Research (Investigate)	From Idea Proposal to Study Planning (Investigate)	Consolidation – ET4ET (Integrate)	LAB Wiki Activities (Align)	
					LAB Course Portfolio (Integrate)
					CLOSURE

Figure 7.8: Schedule for ET4ET₂ in Iteration 3

7.3.2 Refinement in the Model

The design decisions made to cater to diversity and reflections from Iterations 1 and 2, has now been used to refine the A2I2 model in this iteration. Following are the key changes made in the model:

Introduction of design principle of Pertinency

A major challenge while scaling up TPD programmes is the diverse audience attending the programme. The initial versions of the model had partly tried to address this by recommending an output at the end of each phase, from participants' own course. The design decision to use multiple examples familiar for participants' (see section 0) also caters to addressing the problem of diversity. Abstracting these design decisions, we see that both these features make the training content relevant for the participants. This helps us in creating the design principle of 'Pertinency', which is defined as training participant's perception of degree to which the given content is applicable for his/her teaching immediately after the training. *Pertinency* ensures that training designer chooses relevant content and examples to the teacher's immediate

practice, and thereby increases possibilities of sustained impact immediately after the training (Fullan, 2001; Hayes, 2000).

Introduction to design principle of Immersivity

In the Iteration 2, we had identified that the strategy of explaining about technology and then making participants do activity in technology was not creating the intended response while scaling up. Hence it was decided to adopt the same strategy as that done for active learning strategies, i.e. provide participants' an experience of strategy as a student first before explaining the strategy. Abstracting this we get, design principle of 'Immersivity', which is defined as the feature of the learning environment that drives participants to be involved in a set of meaningful activities (Howland et. al., 2012) and to get cognitively engaged in the content (Sherman & Craig, 2003).

Immersivity and Pertinency as substitute indicators for sustainability

Sustainability is identified as a central challenge for scaling up educational interventions (Coburn, 2003). The professional development literature contains various definitions of the term sustainability, with the most prominent ones being those related to long-term continuation of benefits even after termination of the program (DEZA, 2002). Measurements of these benefits are not comprehensive as they can occur either at an individual level (Hargreaves and Fink, 2003) or at the system level (Fullan, 2006) and relate to multiple dimensions of teaching and learning (Antoniou & Kyriakides, 2013).

Researchers have used measures related to change in teachers' knowledge, beliefs and practices as a first indicator to report sustainability. These measures are done repeatedly across time using interviews or survey questionnaires (Henderson, 2007; Zehetmeir, 2015) or by making classroom observations of teacher practice and analyzing the teaching artifacts (Bierman et. al, 2013). Another possible measurement is at the level of students by looking into student behaviours and learning outcomes (Cochran-Smith & Zeichner, 2005). While scaling up, such repeated measurements become difficult either due to lack of material, financial and personal resources (McLaughlin and Mitra, 2001; Hargreaves, 2002) or due to contextual factors like organizational churn or teacher turnover (Shear & Penuel, 2010).

Thus professional development program designers who intend to measure the sustainability of scaled up programs are faced with twin challenges of lack of comprehensiveness and difficulty in taking large-scale measurements with currently used metrics. A possible alternative is the idea of using substitute indicators, as is practiced in ecological studies (Hák, Moldan & Dahl, 2007), right from the start of program ideation (Penuel & Fishman, 2011). A characteristic feature of these substitute indicators should be its ability of communicating relevant information to multiple stakeholders and ability of real-time measurements (Hák, Moldan & Dahl, 2007).

Teachers' perception of positive effects during professional development has been identified as a predictor of sustainability (Scheirer, 2005; Hann & Weiss, 2005). In order to achieve these positive effects, it is important that the program have high teacher engagement, active learning during the program, teacher learning, relevance to practice and changes in teachers' beliefs and attitudes (Desmione, 2009; Wells, 2007; Korthagen, Loughran & Russell, 2006; Steinert et. al, 2006).

Hence we use *Immersivity* and *Pertinancy*, which are built upon the above existing ideas of program effectiveness, as substitute indicators of sustainability.

Implementation of A2I model for training in wikis

With the new column of immersion being explicit, the implementation of the training teachers in wiki now became:

Table 7.10: Design of an entire session using modified A2I model

Phase	Focus	Content		Format (In- Instructor Driven, Pin – Participant Driven Individual Pco – Participant Driven Collaborative)	Immersion of Technology (Informed by Immersivity)	Output (Informed by Pertinency)
		Topic	Level of Knowledge			
Attain	Introduction to wiki	Basic Wiki Operations	Perform basic wiki operations of creating a page, editing contents, commenting	This is done as a lab session and instructions are provided in the wiki main page	Participants use wiki as a student, perform basic edit operations	An individual wiki page
		Wiki – What and Why?	Explain instructional use of wikis Identify features of wiki like membership, editing, access permissions, file upload etc.	This topic was done asynchronously using Moodle, we used the Lesson Module to provide content (In) and short questions at Recall/Understand (Pin). There were Slides (In) and Quizzes (Pin) to ensure that participants complete attain phase	Participants already familiarized with wiki through activities before this session like “Writing of Los in wikipage” .	Explore existing wikis to identify their instructional use Identification of a possible use of wiki in their own course.
Align	Details about wiki affordances and aligning wiki objectives and evaluation	Instructional use of wiki in engineering courses	Create an instructional plan for implementing in their course	This is also done as an asynchronous MOODLE Lesson activity, where participants are expected to fill a worksheet (Pin) to identify an instructional use of wiki	Participants already building their individual portfolio based on wiki activities	Plan for using wiki in their own course
Integrate	Course Portfolio using Wiki	Course Portfolio	Create a wikipage which contains all the resources that they created for the workshop – Learning	This was done as a lab session, where participants were provided with a 5 minute brief instruction on what was	Participants exposed to asynchronous collaboration and	Participants create a course portfolio of their own

			outcomes, Instructional Strategies, Assessment Strategies and Lesson Plans	expected.	commenting	
--	--	--	--	-----------	------------	--

Addition of Investigate Phase

Phase	Focus	Content		Format (In- Instructor Driven, Pin – Participant Driven Individual Pco – Participant Driven Collaborative)	Immersion of Technology (Informed by Immersivity)	Output (Informed by Pertinency)
		Topic	Level of Knowledge			
Investigate	Generate an idea for classroom action research	Novelty and Positioning of research ideas	Sessions in Investigate phase target ability of participants to identify novelty and positioning of research ideas	A mix of instructor guided and participant driven activities.	Identifying innovative ways of using technology and its evaluation strategies.	An Idea Proposal for an action research study

7.3.3 Research Study 3 – Effectiveness of ET4ET₂

To evaluate the effectiveness of the training, we consider the following parameters – Participation rates in the training, Participants’ perceived competence with technology (Kirkpatrick’s levels of reaction and learning). Further, we also try to validate the design principles by asking two research questions about Immersivity and Pertinency of the training programme.

In this research study, we focus on effectiveness of training for three different technologies –Visualizations, Screencasts and Wiki, along with participation rates. The effective integration of technology of the participant is understood in terms of participant perception of confidence in use of technology and rubric based evaluation of participants’ wiki based lesson plans.

Research Questions

The specific research questions for this study are:

- RQ 3.1: What is the completion rate in the programme?
- RQ 3.2: What is the persistence rate in the programme?
- RQ 3.3: Does participants’ perceived competence in the use of technology, increase after the training programme?
- RQ 3.4: Do the participants produce effective wiki integration plans during the training programme?
- RQ 3.5: How pertinent is the ET4ET₂ programme?
- RQ 3.6: How immersive is the ET4ET₂ programme?
- RQ 3.7: How has the participants’ learning from the ET4ET program transferred into actual practice?

Sample

The sample used for perception data consisted of 735 responses that responded to Pre and Post survey for Technology Use and provided their consent for research use. For the lesson design evaluations there were a total of 1074 submissions, out of which we used purposive sampling to shortlist 554 submissions of participants who had submitted all the assignments during the workshop. A random sampling was done then to select 85 participants’ (15%) wiki implementation plan for analysis. To

calculate pertinency, we used the sample of 1202 respondents who replied to the end of training survey.

Data Sources and Instruments

Since the research questions related to evaluation measures both during and after the training the data collection was done at four different time points – (i) During design of ET4ET₂, (ii) During implementation of ET4ET₂, (iii) Immediately after the end of ET4ET₂, and (iv) A semester after the completion of ET4ET₂. The details of the data sources and the evaluation measures used for answering each research question is provided in Table 7.11 below.

Table 7.11: Constructs, Data Source and Metrics for the research study

RQ Answered	Time of data collection	Data Source/Instrument	Metric
RQ 3.1, 3.2	End of Training	MOODLE Assignment submission logs Registration logs	Completion rate, Persistence rate
RQ 3.3	Before and After the training	Technology Competency Survey, adapted from Technology Self Proficiency Survey (Milman, Nortecamp & Peters, 2007)	Perception of competence in “Selection of Technology”, “Use of Technology to design lessons” and “Evaluation of artefacts generated by students using technology”.
RQ 3.4	End of training	Lesson Plan for integrating wiki	Evaluated using a “Technology integration evaluation rubric” that has 3 criteria
RQ 3.5	Before Training	Video Sessions and slides Program schedule	Time spent during the program on active learning activities
	During Training	A-View Chat logs	No of chat interactions to Active Learning strategies.
	End of Training	Moodle Submissions	Active learners based on assignment submissions
	End of Training	Wiki pages	Number of page views, edits and user statistics
RQ 3.6	End of Training	End of program survey	Responses to questions related to relevance and intention to apply
RQ 3.7	One semester after end of training	Open ended response to survey after a semester	Levels of Changes observed

The prior exposure to the participants each of these technologies were collected using another 4-question survey where they rated their exposure as – “I don’t know what it is” (0), “I know what it is”(1), “I have used it”(2) and “I have used it in my course”(3). We have used a questionnaire survey adapted from Technology

Proficiency Self Assessment Survey (Milman, Nortecamp & Peters, 2007). The survey questions were asked on “Selection of Technology”, “Use of Technology to design lessons” and “Evaluation of artefacts generated by students using technology”. These four constructs essentially inform us of the competence in technology integration. The survey utilized a four-scale approach - “I cannot do this”, “I need training to this”, “I can do this with support of resources like books/videos etc” “I can do this independently” and “I can teach this to others”. The cronbach’s alpha for the survey was 0.83 that showed the survey was reliable. To check the validity of survey we did an Exploratory Factor Analysis using Principle Component Analysis with Varimax rotation. The factor analysis had resulted in 2 factors with four elements loading onto each with values greater than 0.6.

The evaluation of wiki integration plans was done using the ‘Technology Integration Evaluation Rubric’ that was created by us. The rubric had three criteria for technology integration: C1 - Matching learning outcome with Wiki affordances, C2 - Aligning use of Wiki affordances for instructional strategy, C3 - Appropriate assessment strategies based on Wiki affordances to measure learning outcomes. Each criterion contained descriptions at four performance levels (scale of 0-3). The criteria of evaluation were the alignment of the use of technology with the intended learning outcomes for the task, instructional strategy adopted and assessment strategy defined. The rubric was used by iteratively modified through discussions of two independent raters till it led to good agreement for all criteria. The reliability scores (Cohen’s κ) for each of the criteria were found to be $\kappa = 0.85$ for C1, $\kappa = 0.85$ for C2 and $\kappa = 0.797$ for C3, indicating high reliability.

Procedure

The survey questionnaires (with open ended feedbacks) were administered via MOODLE.

Data Analysis Technique

Completion and persistence rates were calculated directly using the participation data obtained from the learning environment. We have used Wilcoxon’s Signed Rank test on the pre and post perception questionnaire data to analyse the participants’ perception of technology competency. While doing the thematic analysis we had followed the steps mentioned by Braun and Clarke (2008), wherein two researchers

had used a deductive approach based on the existing literature on different levels of program effectiveness (Kirkpatrick, 1994; Steinert et. al., 2006). Two rounds of coding by both the researchers generated the initial codes and these were clubbed further to generate common themes. The themes were then reviewed once again before refining it a level further and generating three broad common themes related to changes observed at Student Level, Teacher Level and Institution Level. For example, initial codes of student learning, student belief and student practice were clubbed together to form the theme “Changes in Student” which was further refined to “Changes at Student Level”.

Results

(a) Result 3.1: ET4ET₂ has completion rate of 12.7% and persistence rate of 15.6%

As seen from Table 7.12, the numbers of active learners within the training program are 3550 (81.45%) and the number of participants who completed the program successfully is 554 (12.7%). The persistence rate of the program is however 15.6%.

Table 7.12: Assignment Completion data

Number of Assignments	1	6	12	16
Active Participants (%)	3550 (81.45%)	2479 ()	1521	554 (12.7%)

(b) Result 3.2: Statistically significant increase in the perception of competence of wiki and screencasts.

Table 7.13 below show details of prior exposure to the technology and the results of the faculty perception of competence (or confidence) in the use of Technology. It is seen that 76% of participants have not used screencasts before, while 56% have not used wikis before this training.

Table 7.13: Prior exposure of participants' towards the chosen technologies

Technology Prior Exposure	Screencasts			Wiki			Visualizations		
	None	Know	Use	None	Know	Use	None	Know	Use
Frequency (%)	319 (43)	239 (33)	177 (24)	215 (29)	195 (27)	325 (44)	90 (12)	244 (33)	401 (55)

On analyzing their response to the Technology Proficiency Self Assessment Survey, administered pre and post the training, it is seen that the increase in median from pre to post is significant for all the technologies (see Table 7.14). The median increase is prominent in the use of screencasts (useful for Flipped Classroom) and wiki from 1 to 3, i.e. from mere knowledge of the technology (“I know what it is”) to its actual use in their own practice (“I have used it in my course”).

Table 7.14: Perception of competence in use of technology before and after training

Parameter		Screencasts		Wiki		Visualizations	
		Use in Lesson	Evaluate	Use in Lesson	Evaluate	Use in Lesson	Evaluate
Median of Perception	Pre	1	1	1	1	2	2
	Post	3	3	3	3	3	3
Wilcoxon Signed Rank Test		Z=-15.26 r=0.40 p<0.05	Z=-13.73 r=0.36 p<0.05	Z=-11.59 r=0.30 p<0.05	Z=-12.24 r=0.32 p<0.05	Z=-11.93 r=0.31 p<0.05	Z=-11.93 r=0.31 p<0.05

(c) Result 3.3: Participants are able to align the technology affordances with the learning outcomes

From Table 7.15, it is seen that the participants are able to better match the learning outcomes with appropriate wiki affordances (Mean = 2, SD = 0.85), compared to aligning either instructional strategies or assessment strategies. It is also seen that the mean score of alignment with instructional strategies are 1 SD better than score obtained for aligning wiki affordances with assessment strategies.

Table 7.15: Scores of wiki based lesson plan analysis of the participants

Criteria	Mean Score (Out of 3)	SD
Matching learning outcomes with wiki affordances	2	0.85
Aligning use of Wiki affordances for instructional strategy	1.80	0.82
Appropriate assessment strategies based on Wiki affordances to measure learning outcomes	1.17	0.72

(d) Result 3.4: Participants find the training highly immersive

The immersivity of ET4ET implementation is observed in all the three learning environments, i.e, A-VIEW, Wiki and Moodle. We see that within the A-VIEW sessions there were sufficient amount of active learning strategies that kept the participants engaged. The evidence for the engagement comes from the chat messages received in the A-VIEW sessions during each of the strategies. From Table 7.16 below, we see that 37 active learning strategies were used across the 7 sessions that totaled to 3.5 hours of active engagement (or 51% of instructional time). In terms of remote center participation, we see that the average interaction per strategy is 130, i.e. 87.8% of remote center participation.

The participants were provided with 8 Wiki tasks that required them to create 4 different Wiki pages per person and 1 page per remote center and perform at least 10 edit operations. It was seen that over the course of the program, 1009 different participants had generated 6279 pages and performed 21487 edits. With respect to the 3551 synchronous session participants, the participation rate in Wiki had dropped down to 28%. However, in terms of activity presence within the Wiki we can see that participants have created an average of 6 pages per person and performed 21 edits per person. In terms of remote center presence, participants from 59 different remote centers (40%) were active in the Wiki.

Table 7.16: Data related to immersivity of the training

		Day I		Day II	Day III		Day IV		TOTAL
	Session	2	3	2	1	3	1	3	
Design of Program	Time in min for active learning (Session %)	31 (34 %)	30 (33%)	29 (32%)	47 (52%)	30 (33%)	44 (49%)	5 (17%)	216 (51%)
Implementation of Progra	No of active learning activities	4	4	7	11	3	6	2	37
	No of Chat messages	347	427	1336	1090	492	874	227	4793

(e) Result 3.5: Participants found the training content highly pertinent

The analyses of responses to the post-program survey are shown in Figure 7.9. We see that there is a uniform high perception about relevance and intention to apply both strategies and technologies. The analysis of survey responses further shows strong correlation ($p=0.000$) between relevance and intention to apply the technology ($\rho_{FC} =$

0.464, $p_{\text{Wiki}} = 0.507$) and strategies ($p_{\text{PI}} = 0.435$ and $p_{\text{TPS}} = 0.481$). It is seen that more than 84% of respondents indicated positive response towards relevance of Think-Pair-Share and Peer Instruction strategies while the ratio became 82% and 79% for Flipped

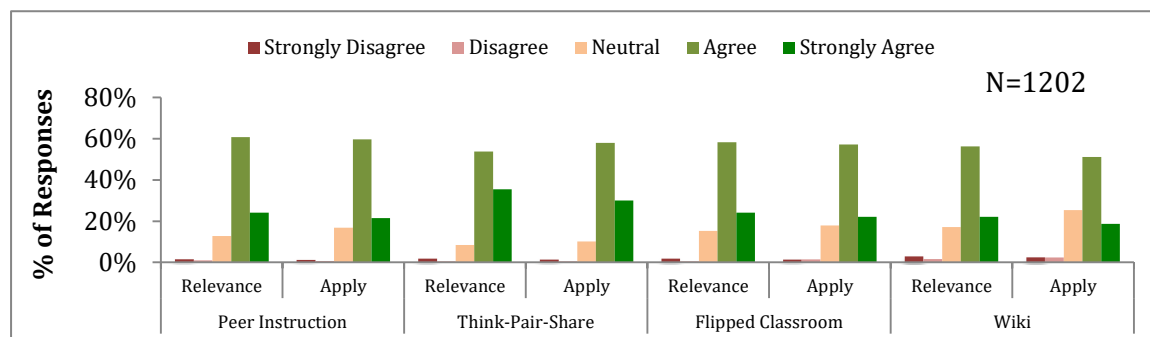

Figure 7.9: Results related to pertinency of training content

classrooms and Wiki respectively. The intention of applying Think-Pair-Share as a strategy was found to be highest at 88%, while intention of applying Wiki was found to be the least at 70%.

(f) Result 3.6: Effects of changes in practice after training felt at three levels – At student level, At teacher level and At institution level

Thematic analysis (Braun & Clarke, 2008) of the open-ended responses has revealed three broad themes about which effects of the program were observed: Effects at student level, effects at teacher level, and effects at institution level. The first theme of interest is the changes observed at student level. Most of the respondents felt increased engagement of the students and its effect on the student learning. This is best highlighted by the comment *“I was able to engage the backbenchers with the activities and that was reflected in their exam results.”* The teachers also felt that applying workshop learning has facilitated better learning attitudes and beliefs from students, as is evident from the comment *“Students are more focused about the Learning outcomes”*, and *“students are more aware about what is being taught for what purpose.”* Comments like *“My students were able to answer those questions which was not discussed in detail”* indicated a positive perception towards students’ learning practices after attending this workshop.

At the teacher’s level, they have indicated changes in beliefs and attitudes, and practice. The attitude shift from a teacher-centric or content oriented approach to a more a student centric or learning oriented approach is quite evident. Comments like

“[I was] Thinking from a student perspective rather than a teacher perspective” or *“The teaching becomes more focused to [student’s] learning outcomes”* bear evidences for the same. Some participants indicated improvement in self-belief as seen from comments like *“I feel I can handle the class with more confidence”* and *“... able to apply learnt practices, hence feeling happy”*. They also feel that their practices have improved to make classes more interactive and engaging and that is indicated from the comment *“In each class I am successful in grabbing the attention of every student in the class by making them to involve in one or the other activity.”* There was a comment on the evaluation activity, where the teacher had mentioned, *“[Question] Paper setting is improved after attending the workshop.”* The comment *“... ICT enabled teaching methodology will be fruitful in future if we follow it regularly”* brings out the need to sustain these practices to bring about positive changes.

At the institution level, two teachers clearly indicated the explicit effort made by them to disseminate the learning from workshop. A teacher had commented *“we also conducted a training program for about 120 faculty members out of 350 in our College and shared the important topics of this workshop.”* This teacher indicated their plan to sustain this effort - *“We have also planned to conduct another phase of this workshop to convey all the topics in the near future.”*

7.3.4 Reflections and Implications of Iteration 3

- Adaptations of active learning strategies in SRC setting was used once again in Iteration 3 to scale A2I2 model.
- Result 3.1 reconfirms the high participant attrition when you scale the training programmes. The persistence rate of 15.6% and completion rate of 12.7%, though comparable with similar large-scale courses (Jordan, 2011), is lower than the persistence rates observed in Iteration 2. The lower completion rates can be attributed to the increased scale larger number of inactive participants in Iteration 3 (18.55%) compared to Iteration 3. However if we look at persistence rates till 75% of assignments (i.e. 12 out of 16) we see that persistence rates are comparable. Since the certification criterion was kept at 50% assignment submission (i.e. 8 out of 16), this might have led more participants to dropout after achieving the required criteria.

- Statistically significant increase in perception (from “Need training” to “Use Independently”) in Result 3.2 for wiki, along with high engagement displayed in wiki activities (Result 3.5) and learning (Result 3.4) help us to infer that the training for wiki using A2I2 model was effective.
- From Result 3.5 we see that the participants have high intention to apply classroom-strategies, like Think-Pair-Share (88%) and Peer Instruction (84%), more than purely technology-based strategies like Wiki (70%). One possible reason could be the challenges to lesson design with technology observed by instructors in technology-constrained classrooms, that are prevalent in the context of the ET4ET programme (Banerjee, Murthy and Iyer, 2015).
- High Immersivity and Pertinency (Result 3.5 and 3.6) coupled with significant changes in practice after a semester (Result 3.7) indicate medium-term sustainability of the training benefits. The three levels of changes in behaviour, i.e. at student level, teacher level and institution level, indicate that the training has actually improved the capacity of the system as a whole, which is as per the DBIR principle. With positive results in participation, reactions and learning validated across multiple iterations, the next iteration in blended mode need to focus on sustainability to completely validate the model.

7.4 Iteration 4

This is the third training in this mode (See below). In this we use the refined A2I2 model (Model₂), based on the reflections from Iteration 3, to develop the training programme – ET4ET₃. Based on the reflections from Iteration 3, the training goal for this iteration was to increase sustainability of the technology integration of practices.

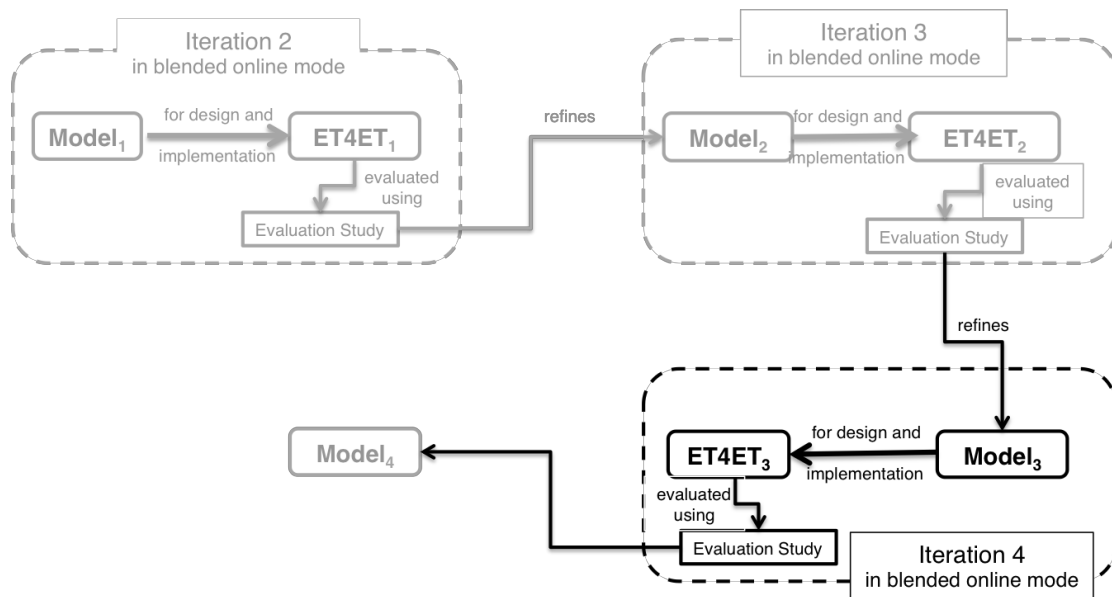

Figure 7.10: Implementation of ET4ET4 in Iteration 4

7.4.1 Overview of the training ET4ET₃

The participants of this training are 53 members, who participated in either Iteration 2 or Iteration 3 and volunteered for the training. Participants were provided training in a new technology – Padlet™, in this iteration using A2I2 model. The training utilized the technology platforms of MOODLE, Wikispaces and Padlet. 10 among these attended a face-to-face short-term training for classroom action research. The focus of this iteration is to evaluate the sustainability of the A2I2 model by expanding the investigate phase to include transfer of ownership via classroom action research. There were two phases of training – (i) An asynchronous online training, equivalent to an instruction time of 1.5 weeks, started in June and ended in October, and (ii) A face-to-face training in classroom action research training, which lasted for 3 days, during the final week of October (October 23-25).

7.4.2 Refinement in the Model

In this iteration we have refined the investigate phase by introducing two distinct stages inside it – idea proposal stage and study planning stage. To assist them in the process, scaffolds have been provided for idea generation and study planning to improve the practice by performing classroom action research. We call these scaffolds ‘*Idea Planning Template*’ and ‘*Study Planning Template*’ (Murthy and Iyer, 2013).

Both these templates are based on the broad criteria of evaluation of research papers – Novelty, Positioning, Strength of Procedure and Results (Smith, 1990).

To ensure Immersivity we have created these templates in wiki and used wiki extensively for asynchronous discussion. The wiki pages for idea planning and study planning are provided in Appendix E and F respectively.

7.4.3 Research Study 4 – Sustainability of Training

Research Question

RQ 4.1: What changes were observed in the ownership of problem from trainer to the teacher over the course of training?

Sample

The sample for the research study consisted of 9 participants who provided end of semester feedback for the training benefits and also participated in focus group discussions at the end of this iteration.

Instruments

This study used the idea planning and study planning artefacts created by these participants in the programme wiki. Additionally focus group discussions were conducted with the training participants to understand the effect of investigate phase in sustainability of training benefits.

Data Analysis Techniques

Content analysis was performed on the wiki artefacts to classify them on the basis of technology and pedagogy utilized for solving problems of practice and performing classroom action research. The focus group discussions were transcribed and a thematic analysis was performed on it.

Results

The focus group discussion highlighted the effect of design principle of immersivity and transfer of ownership has led to significant positive effects in participants' own practice. Comments like “*while introducing a new tool to us, in the pedagogy workshop [Iteration 2_{bo} and 3_{bo}], Wikispaces, they [Researchers] have treated us as a learner*” and “*Because of the training what we have experienced here [Iteration 2 -*

4], the same level of training we are followed in our classroom to create a familiarity of the tool. Now the students are asking whether we can use wikispace or some other tool for our course” indicate how the learner-centered designs (for Immersivity) led to positive practices and experiences. The discussions also shed light on evidences of how the student attitudes and behaviour changed after their teachers devised more learner-centered strategies using technology. Comments like “*The real time problem skills have been improved because of these activities.*” and “*at the end of the semester the feedback what we got from the students is we [students] have learned inside the class itself*” also indicate the learning benefits that the students are exhibiting. The participants also indicated how the students, taking examples of specific tools that they were trained in, appreciated their technology integration practices. E.g. the comment “*the students are so much interested whenever the staff comes to our class, we will be using wikispace. So we will be posting materials there, we will be getting materials, we will be doing activities there, mini projects in a team work, so they [students] have too much interest to work with the tool [wikispaces]*” indicates how ownership of technology integration practices are being taken up actively by teachers.

9 participants had submitted a research idea during the idea proposal stage. On closer examination of these idea proposals it was observed that all the others have made use of either the strategy or technology that they were trained in. As seen from the table below, four participant ideas utilized technology of Visualizations, two utilized Padlet and one used Wiki. Three of the ideas utilized the strategy of TPS while one study utilized PI for effective technology integration. An example of ideas was “Use of Padlet and TPS in a flipped classroom strategy to engage participants in discussions within the topic of CPU Scheduling”.

At the beginning of study planning stage, the nine participants discussed and iterated on the initial ideas and created 7 study plans. It was seen that the discussions had resulted in formation of two group submissions along with five individual submissions. At this stage we had five participants who are using Wiki within their studies, two using Visualizations and one utilized Padlet. Among the changes observed, one group had now created a study that utilizes Wiki for conducting TPS and another group was thinking of creating a technology tool to conduct TPS for online classes. The creation of Idea and Study planning templates exhibit a complete

transfer of ownership of the problem of technology integration from the trainer to the participating teacher.

Out of this 4 participants had submitted their studies to a peer-reviewed conference, of which 3 of the studies were accepted after reviews. The remaining participants were not able to initiate research studies citing academic workload and health reasons.

7.4.4 Reflection from Iteration 4_{bo}

In terms of programme design:

- a. As seen from the comments made on the use of Wikispaces, we infer that the design principles of Immersivity has helped teachers to provide effective learning experiences for their own students while using technology
- b. The activities done by the participants in this iteration show that design feature of pertinency and transfer of ownership has ensured that participants are able to sustain the benefits for medium term after the training programme closure.
- c. The scaffolds of idea and study planning templates has helped participants to refine their ideas into educational research studies

In terms of programme implementation:

- a. Most participants were unanimous about the need for time to practice the new skills. Thus while implementing a new training sufficient time for practice have to be provided before introducing concepts of classroom action research.

7.5 Reflections from the Blended Online Implementation

From the overall blended online implementation, the following reflection points are noted.

- a. To ensure the immersivity of the participant in active learning strategies, the training program designers are first required to design pedagogical modifications similar to the AL in SRC model explained in section 7.1.3.

- b. The results from Iterations 2 and 3 validate the scalability of A2I2 model. The results from iterations 3 and 4 validate the medium-term sustainability associated with training programmes designed using A2I2 model.
- c. As the iterations progressed, the model was enriched by detailed operationalization of the design principles. e.g. for attain phase the Immersivity was explained as “More instructor guided activities before explanation on affordances of technology”. This will help training designers to better apply the model in their own context.
- d. Though iterations 2 and 3 showed attrition of participants, the completion rates (19% and 12% respectively) were comparable with other large-scale offerings (like MOOCs having similar participation).
- e. Scheduling the training just before the start of instruction allows participants to plan for immediate use of knowledge and skills in practice, thus increasing pertinency.
- f. Blended mode allows participants sufficient time for practice between two phases of interaction with the trainers.

Chapter 8

Implementation of Model – Massive Open Online Mode

In the previous chapter we had explained the use of A2I2 model in scaling the technology integration training programmes in a blended online mode, also called as synchronous remote center (SRC) mode. Scaling up teacher professional development (TPD) has always been a challenge within the academic community – both in terms of cost involved and also in terms of quality (Jobe, Ostlund, & Svensson, 2014). Some of the existing solutions that target the issue scaling are Communities of Practice (Triggs & John, 2004) and blended online TPDs that were seen in the previous chapter. With the increased access to Internet among teaching community, the emergence of massive open online courses (MOOCs) provides a viable alternative to scale TPD efforts.

In this chapter we will detail out the use of A2I2 model to design and implement the training as a MOOC – “Educational Technology for Engineering Teachers (ET601Tx)”, termed as ET4ET₄ that trains the participants in effective technology integration. This is also the fifth iteration of design of training programmes based on the A2I2 model in our DBIR cycle. In section 8.1 we provide an overview of the implementation features of the course like course goals, duration, format etc. followed by the detailing of implementation of A2I2 model in MOOC. The implementation is explained by detailing pedagogical designs for MOOC in 8.2.1, implementation of

design principles of Immersivity and Pertinency in 8.2.2. we detail how the design principles of were utilized in the design of MOOC followed by the research study undertaken to evaluate this implementation in section 8.4. The reflections from this iteration are then explained in section 8.5.

8.1 Overview of ET4T₄(Iteration 5)

ET4ET₄ is an 8-week TPD MOOC titled “Educational Technology for Engineering Teachers” (ET601Tx) offered through IITBombayX (IITBombayX, 2016) platform (xMOOC platform), from 7-January to 7-March, 2016.

Table 8.1: Description of ET801Tx

Sl No	Features of the MOOC	Description
1	Course Goals	Train Engineering College instructors in constructive alignment practices for effective integration of technology in their classrooms.
2	Course Duration	07-January, 2016 to 07-March-2016 (8 weeks)
3	Course Format & Content	Weekly Release of contents with due dates on 2 nd , 4 th and 8 th week. The contents include – Learning outcomes, Active Learning Strategies (Think-Pair-Share, Peer Instruction), Assessment Strategies, Integration of Visualizations, Digital Blooms Taxonomy and Lesson Planning. 4 th and 7 th week were catch-up weeks, with only practice activities and discussions
4	Course Components (in each week)	Learning Dialogue (LeD) Videos for content coverage, Learning by Doing (LbD) Activities for concept reinforcement, Learning eXTension Resources (LxT) for extending learning, Resource Creation Assignments (RCA) for practice (except 1 st , 4 th and 7 th week)
5	Estimated Weekly Effort	5-7 hours
6	Certificate Policy	Pass percentage – 50% overall Only Honour Code Certificates
7	Evaluation Criteria	Automated Assessment – Best 19 out of 22 Quizzes, that are further divided into Knowledge Quiz – Best 9 out of 11 Nos, having 60% weightage Reflection Quiz – 6 Nos, having 10% weightage Resource Creation Quiz – Best 4 out of 5 Nos, having 30% weightage

The course goal was to train engineering faculty in learner-centered pedagogy and constructive alignment, which is found to enable effective technology integration in classroom. Though the course primarily targeted the engineering college instructors, it was kept open for learners interested in effective classroom technology integration practices. The course had an initial enrolment of 3456 participants that increased to 5105 across the total duration. There were a total of 159 deregistration in the course during the same time period. Table 8.1 shows a brief description of the course.

8.2 Implementing A2I2 Model in MOOC

While moving from a blended-online (Iterations 2-4) to a purely online mode, training designers are faced with three key design challenges:

- Choice of training content and its sequencing within new training environment
- Adapting the pedagogy to maximise participant engagement in a purely online setting
- Catering to the diversity of learners, in terms of diverse backgrounds and diverse learning goals

The A2I2 model requires ‘Learning outcomes’, ‘Active Learning Instructional Strategies’, ‘Assessment strategies’ and ‘Technology’ to be part of its content which moves across the phases of Attain-Align-Integrate-Investigate to train participants in constructive alignment. During iteration 2 and 3, we had developed purely online training sessions for design of active learning strategies (Attain-Align phases) and lesson design using visualizations and screencast (Align-Integrate phases). Thus while transitioning into MOOC mode, we focused on implementation of the Attain-Align-Integrate phases of the A2I2 model so as to assist participants in creating student-centered lesson designs.

To solve the challenge of selection of technology, we explored the technologies trained in the previous iterations in an online mode. It was seen In the iterations 3, we have implemented the following contents in pure online mode - Design of active learning strategies (Attain-Align), Design of flipped classrooms (Integrate) and Design of lessons that integrate visualizations (Integrate). Thus while transitioning into MOOC mode, we focused on implementation of the Attain-Align-Integrate

phases of the A2I2 model so as to assist participants in creating student-centered lesson designs. Since the participants were moving to a new platform, the design principle of Immersivity guided us in selecting the technologies for the training. Though wiki was available in the IITBombayX platform, the learning curve for the formatting and editing was very high, thus restricting the level of immersion. Since we did not focus on blended instruction, use of screencasts was equivalent to use of videos in the learning content. Thus we decided to focus on the integration of visualizations alone, similar to Iteration 1, with a separate week on ‘Digital Blooms Taxonomy’ to expose participants to various technology tools.

From iterations 2 and 3, we can see that there is progressive participant attrition as the course duration increases. To reduce this, we had kept two catch-up weeks, and focused on explicit reflection of the contents dealt in the previous weeks. This also provided participants sufficient time to attempt the graded exercises. Thus the overall content distribution for the MOOC is as shown in Table 8.2 below.

Table 8.2: Overall Schedule of ET4ET₅ based on A2I2

Week 1	Learning outcome (Attain)
Week 2	Active Learning – Think Pair Share (Attain-Align)
Week 3	Active Learning – Peer Instruction (Attain-Align)
Week 4	Catch up week – Reflection activities
Week 5	Assessment Strategies (Attain-Align)
Week 6	Technology Integration – Visualization (Attain-Align)
Week 7	Digital Blooms Taxonomy
Week 8	Lesson Planning (Integrate)

In the following sections we will be detailing how the implementation of A2I2 model helped in reducing these challenges.

8.2.1 Pedagogic Design

As the mode of implementation moves to a completely asynchronous online setting, it becomes important for the trainers to make modifications in the training pedagogy by effective use of features of the training environment. This is to ensure that participating teachers experience active engagement with both content of training and with peers participating in the training (Cho & Rathbun, 2013). The A2I2 model also recommends use of active learning – both as an implementation strategy and content of the training. Thus when we explore features of the training environment, for

implementation, we will have to ensure that interactions of the participants with both content and their peers become active, i.e. participants go beyond just viewing content, writing notes or executing prescribed procedures to discuss, reflect and express their thinking (Meltzer & Thornton, 2012).

The learning platform of this MOOC, IITBombayX, is developed from Open Source edX. This is an example of an xMOOC platform where structure is highly centralized and linear (Margaryan, Bianco, & Littlejohn, 2015), with three key components - videos, problems (multiple choice and open-ended) and discussion forums. Inline with the interactions identified in the iterations during the blended online mode (section 7.2), first we explore the different types of interactions possible in a MOOC setting. With trainers/facilitators also being a participant in this setting, we can identify two broad types of interactions in this mode– Participant-Content interaction achieved through watching the video components and solving the problem components, Participant-Participant interactions achieved through discussions in the forum component. Thus three pedagogical designs were made in this training, one for each of the identified component, to ensure active engagement of participants.

Learning Dialogue (LeD) Videos

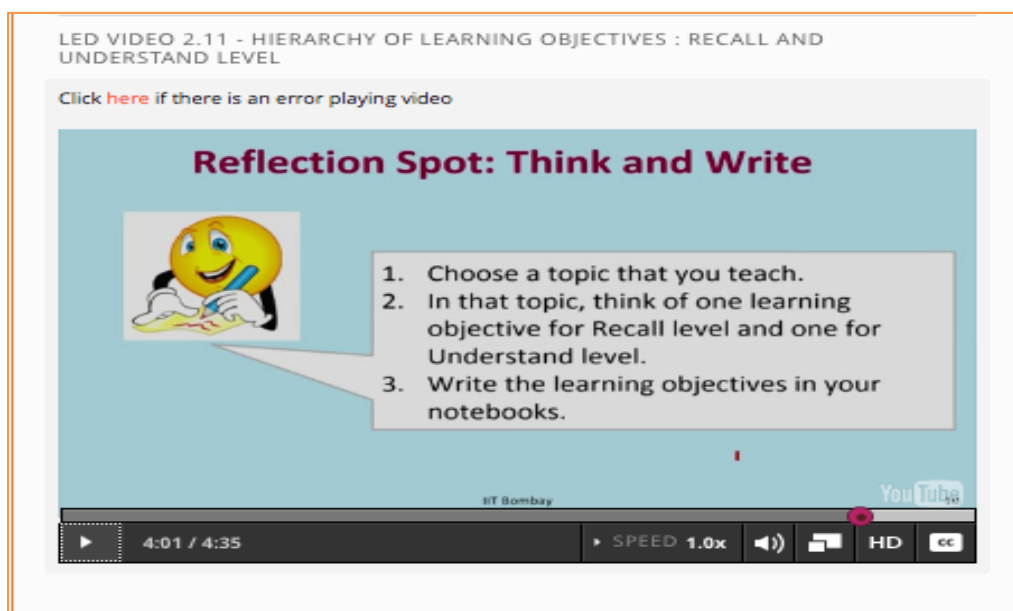

Figure 8.1: Reflection Spot in an LeD Video

The first adaptation, termed Learning Dialogue (LeD) videos, has been made in the platform component for watching videos. Each week will contain a set of Learning Dialogue (LeD) videos to provide information to the participants about the concepts being discussed in the respective week. The LeD videos have ‘pause points’ (Reflection Spot) within it that require participants to pause the video and think about a question posed at that moment (See Figure 8.1). The participants can write the answer in their own notebooks/text document, but they are expected to proceed only after doing this reflection. For instance, the LeD in Figure 8.1 regarding hierarchy of learning outcomes, the learner is asked to think and write one learning outcome at each “Recall” and “Understand” level from their own domain before proceeding with the video. This design will ensure that participants get engaged with content being discussed in the video, i.e. hierarchy of learning outcomes at recall and understand levels, and go beyond mere viewing or writing to explicitly reflect by writing learning outcomes at recall and understand levels based on what they learnt till then.

Learning by Doing (LbD) Activities

The second adaptation, termed Learning by Doing (LbD) activity, is implemented on the problem component that follows the videos. Every LeD video is always followed by at least one ‘Learning by Doing’ (LbD) activity, which are kept ungraded. These are short conceptual practice questions with detailed feedback (see fig 2). They are aimed at reinforcing the concepts that are discussed within the LeD videos and the detailed feedback acts as a proxy for instructor-learner interaction within the MOOC. Typically an LbD question might target lower order cognitive levels, however if required these can be designed for assessing higher order cognitive levels. For instance for the LeD described above, one of the corresponding LbD activity is shown in fig 8.2. In this LbD, the practice activity is a multiple choice quiz asking participants to identify the learning outcome at “Recall/Understand” level for a topic in ‘Digital Logic Design’ (comprehensible for teachers from Electrical, Computer Science and Mathematics). Participants are first expected to identify the action verbs that are used to write the learning outcome in each of these choices. Then they have to identify the ones at Recall/Understand cognitive levels, which was explained in the LeD shown before (Figure 8.2). Once they attempt, they can click on “Show Answer” button to get the detailed explanation provided by the instructor as to which of the choices is at appropriate level and the reasons behind this.

LBD ACTIVITY 1.3 : Q3

Identify learning objectives that are either at recall or understand levels of Revised Blooms Taxonomy. These are from the domain of Electrical Engineering and the course is "Digital Logic Design" (a second year Undergraduate course)

At the end of lesson on "Logic Gates", student will be able to write truth table for 'AND' gate. ✓

At the end of lesson on "Logic gates", student will be able to predict the outputs of given combinational circuits. ✗

At the end of lesson on "Logic Gates", student will be able to design a half-adder circuit using least number of logic gates.

EXPLANATION

In the recall or understand level the students are expected to either reproduce what they remember or what they comprehend from the lesson. Writing truth table of AND gate would require the students to either remember and reproduce it from the text/slide or comprehend the working of AND and then write it.

CHECK HIDE ANSWER

Figure 8.2: An LbD activity with detailed explanation to reinforce the concepts learnt

The other questions in this LbD came from concepts related to 'Loops' (comprehensible for teachers from Computer Science) and 'Fluid Dynamics' (understandable for Mechanical, Civil, Chemical Electrical and Aerospace engineering). Thus the LbDs provide an opportunity for reinforcing the concept that they learnt in the previous LeD with an additional feedback from the instructor.

Forums for Learning experience Interactions (LxI)

Each week of the course will contain at least one discussion forum that is focused and guided towards the practice of the concept/skill being discussed in that week. We term these as Learning experience Interactions (LxIs). To participate in these discussion forums, the participants have to first perform an activity connected to the core concept being discussed in that week. The participants are then required to share their experiences with the community through this discussion forum, after which they are provided with instructions to further discuss about these experiences in a focused manner. For instance, in the section where "learning outcomes" are being detailed, the discussion forum requires participants to do create one student-centered learning outcome and share it with the students in the class (Figure 8.3). They are then required to share their experiences of students' reactions after being told about the

learning outcomes expected from them. When participants start sharing their experiences, these will pave way for more social interactions (Participant-Participant) that allows them to internalize the concepts learnt during that week (Cho & Rathbun, 2013)

These discussion forums are followed by graded reflection quizzes that are based on the discussion forum. The grades associated with these reflection quizzes are not very high, but sufficient enough for a participant to persevere in the discussion forum (10%).

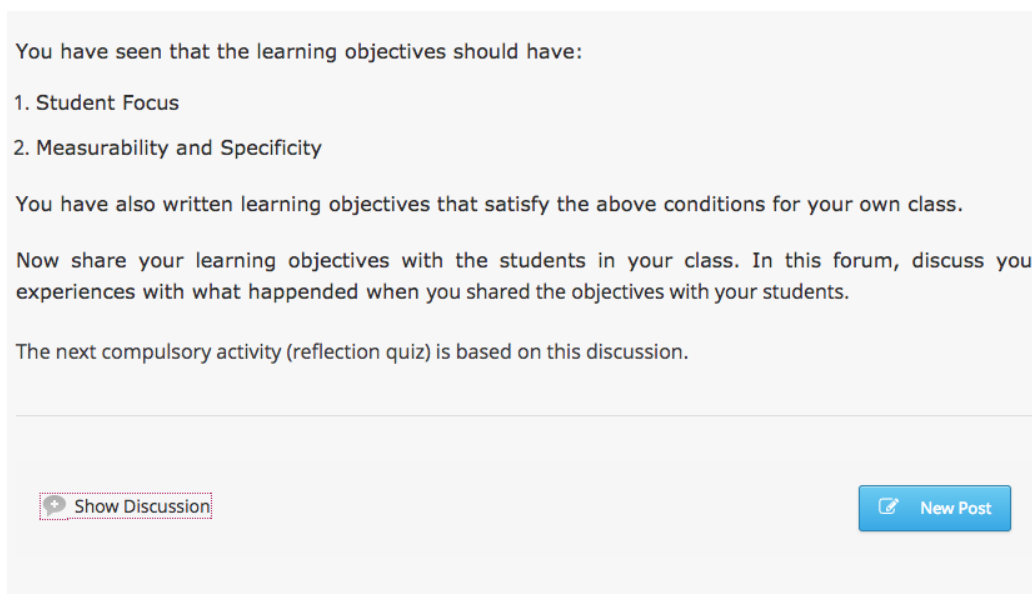

Figure 8.3: Discussion Forums for sharing learner experiences

8.2.2 Implementing design principles of A2I2 model in a MOOC setting

The second challenge of catering to diversity of participants was addressed

Pertinency in ET60ITx

We ensured pertinency of the MOOC content by:

- Ensuring that the course duration largely coincided with the regular academic semester of participating teachers, thereby allowing them to perform lesson design for their own course.
- Providing extensive examples from participants' own domain while discussing contents of the course. E.g. providing examples of well-constructed Learning

outcomes from multiple domains while discussing the topic of Learning outcomes.

- By asking participants to work on assignments on a topic that they plan to teach in the current semester.
- Linking discussion forum activities with their actual practice. E.g. encouraging them to practice the Think-Pair-Share in the class and share their experiences.

Immersivity in ET601Tx

We introduced Immersivity in the MOOC environment by:

- Providing points of reflection (pause points) within Learning Dialogue videos
- Providing detailed feedback in the practice exercises
- Using learner-centered strategies with available visualizations prior to explaining how visualizations can be made effective with these strategies

8.3 Evaluation of ET4ET₄

8.3.1 Research Question

To evaluate the implementation of the model in MOOC setting we tried to answer the following research questions:

RQ5.1: How effective was ET601Tx in the existing MOOC metrics of - Completion rate, Learner retention (persistence rate) and Engagement

RQ5.2: What is the learner perception about usefulness and relevance of the activities in ET601Tx?

8.3.2 Research Method

Table 8.3 below shows details of the data source, instruments and data analysis techniques used to answer the research question.

Table 8.3: Details of data sources, instruments and data analysis techniques

Research Question	Data Source and Instruments Used	Analysis Technique
RQ8.1	Course User Activity Logs in database User grading data from database	Frequency analysis of activity logs and course grades.
RQ8.2	Responses to course end survey (N=688) and Questionnaire Survey (5-point Likert Scale)	Frequency analysis of responses related to usefulness

8.3.3 Results

Result 5.1: 67.4% Active Participants and 36.58% completion rates

The course had a total enrolment of 5264 student enrolments along its duration and 159 unenrolments. Of this only six unenrolments happened after the start of the course. Hence for all calculations we take the number of enrolled students to be 5111. Of these only 3447 students (67.44%) accessed the course at least once and hence can be considered as active learners. The completion rates are calculated both on the basis of overall enrolment and active enrolments. It is seen that 1261 students were certified in the course making the completion rate to be 24.67% of overall enrolment and 36.58% of active enrolments.

Result 5.2: 5023 Threads started and 9861 comments by participants across 8 week

The discussion forums were highly active throughout the course with at least one 'Learning experience Interaction' being created every week. There were a total of 32 discussion forums created across the 8 weeks of the course. It was seen that 1201 participants (34.8% of active enrolments) were active in the discussion forum contributing 5023 Threads and 9861 comments. This would mean that on an average there were 4 Threads and 8 discussion comments per active participant in the discussion and 465 posts per forum. Comparing to some of the existing courses it is seen that this number is a good representation of an active discussion forum. 'ICT in Primary Education MOOC', which was a 6 week course, reports an average of 327 posts for the discussion forums (Laurillard, 2014).

Result 5.3: An average of 399 participants accessed the course daily

While looking across the daily access log we see a response as shown in fig 3. Here the blue upward bars indicate the participants who were successful in getting a certificate and the red downward bars indicate those who didn't. It is seen that, on an average 292 certified participants accessed the course, while only 106 non-certified participants logged into the course daily. However the averages of the non-certified

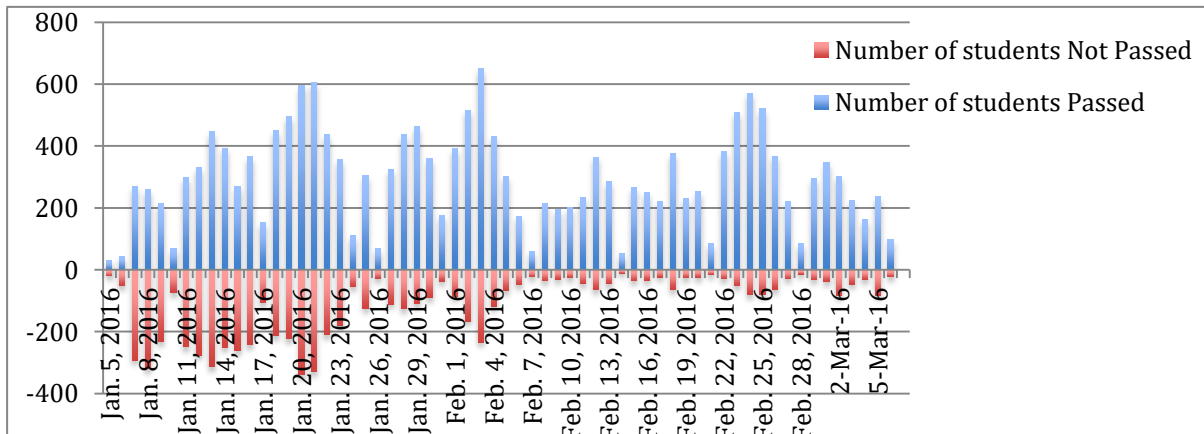

Figure 8.4: Daily participation of users in ET601Tx

participants drop sharply around mid-point of the course (4-weeks).

Result 5.4: High relevance and usefulness for LeD Videos, LbD Activities and Discussion Forums

On analyzing the responses to the end of course survey, it is seen that more than 80% of the respondents find the LeD Videos, LbD activities and Discussion forums relevant for their practice and useful (see Table 8.4).

Table 8.4: Relevance and Usefulness of Pedagogical Features in ET601Tx

N=688	Strongly Disagree	Disagree	Neutral	Agree	Strongly Agree
Relevance of LeD	11	13	54	254	359
Usefulness of LeD	10	8	45	247	381
Usefulness of LbD	8	8	41	234	400
Relevance of Discussion Forum	7	28	100	266	290
Usefulness of Discussion Forum	4	31	111	258	287

8.4 Reflections from Iteration 5

The following were the key reflections from this iteration:

- A. In terms of program design:
 - a. A2I2 model can be implemented in Massive Open Online settings with few pedagogic adaptations.
 - b. Immersivity and Pertinency based design of online modules helps in providing comparable persistence rates with other Massive Open Online offerings
- B. In terms of implementation:
 - a. The scheduling of course should allow participants sufficient time for practice in their own context.
 - b. Practice based Discussion Forums act as a tool for reflection and collaboration.
 - c. Incentivizing (minor way) the discussion forum (like use of Reflection Quiz) can be one possible strategy to sustain the engagement of participants

This iteration has thus helped in validating the A2I2 model in a third setting, fully online, with the largest scale. Thus across the five iterations we have moved from trainings implemented with complete instructor synchronous presence to synchronous absence. In the next chapter, we summarize the results from all the iterations and discuss the implications of the results of all five iterations.

Chapter 9

Discussions and Recommendations

The specific problem being addressed through this research is –“ How can we improve the design and delivery of training programmes to the in-service faculty in engineering education within India to enable them in effectively integrating Information and Communication Technology (ICT) tools within their teaching-learning context?” Our solution to this problem was the A2I2 model for designing training programmes. Thus the research had two broad goals while answering the problem statement.

1. Design and Development Goal –Design and development of a scalable model that will assist in implementation of TPDPs for technology integration
2. Evaluation Goal – Implement and evaluate effectiveness of training programmes created from the model

Five iterations of training were designed and implemented using the A2I2 model in three different modes. To examine the effectiveness of the model, we evaluated each of the training programmes using the Design Based Implementation Research methodology. Evaluation of the training were guided by the constructs of:

- Reaction, Learning and Behaviour, provided by Kirkpatrick’s(1996) levels of evaluation
- Completion and Persistence rates in large scale programmes

- Sustainability of training benefits

The five broad research questions are:

EQI. What is the perception of participants' at the end of training designed based on A2I2 model?

EQII. What is the learning of participants' at end of training designed based on A2I2 model?

EQIII. What is the post-training behaviour of participants who attended the training designed based on A2I2?

EQIV. What are the persistence rates when the training is scaled using A2I2 model?

EQV. How sustainable are the training benefits?

Each of the training programme was evaluated to answer specific research questions under these five evaluation questions. The table below shows the mapping of evaluation questions to the research questions in individual iterations, and the refinements made on the model.

Table 9.1: Mapping of broad research questions to the research questions in individual iterations

Iteration (Training)		Iteration 1 (ET4ET ₀)	Iteration 2 (ET4ET ₁)	Iteration 3 (ET4ET ₂)	Iteration 4 (ET4ET ₃)	Iteration 5 (ET4ET ₄)
Mode		Face-to-Face	Blended Online			Massive Open Online
Research Study		Study 1	Study 2	Study 3	Study 4	Study 5
A2I2 Model Version		Model ₁	Model ₂	Model ₃	Model ₄	Model ₅
Evaluation	EQ I: Persistence	-	RQ 2.1	RQ 3.1, 3.2	-	RQ 5.1
	EQ II: Reaction	RQ 1.1	RQ 2.2, 2.3	RQ 3.3	-	RQ 5.2
	EQIII: Learning	RQ 1.2	-	RQ 3.4	-	-
	EQIV: Behaviour	-	-	RQ 3.7	-	-
	EQV: Sustainability	-	-	RQ 3.5, 3.6	RQ 4.1	-
Impact of evaluation on Model		Validated A2I2	Scaled A2I2	Design Principles of Immersivity and Pertinency in A2I2	Refined Design principle of Transfer of ownership for sustainability	Scaled A2I2 for fully online

Thus across the five iterations, in three modes, we have strengthened the model based through repeated evaluations across these five different metrics. In the next section we look at the summary of results of the research questions.

9.1 Summary of Results

9.1.1 Persistence rates while scaling

The results regarding persistence and completion rates across the iterations are shown in Table 9.2 below.

Table 9.2: Summary of Results for RQI

Training (Iteration)	Research Question	Result
ET4ET ₂	RQ 2.1: What is the completion rate and persistence rate for ET4ET ₁ training developed from A2I2 Model ₁ ?	Completion Rate = 15.3% and Persistence Rate = 20.6%
ET4ET ₃	RQ 3.1: What is the completion rate in the programme? RQ 3.2: What is the persistence rate in the programme?	Completion Rate = 12.7% and Persistence Rate = 15.6%
ET4ET ₄	RQ 5.1: How effective was ET601Tx in the existing MOOC metrics of - Completion rate, Learner retention (persistence rate) and Engagement?	Completion Rate = 24.7% and Persistence Rate = 36.58%

9.1.2 Reaction of participants after training

The reactions of participants to training were analyzed through end of training questionnaire surveys. Table 9.2 shows the relevant research questions across each iteration and its answers.

Table 9.3: Summary of results related to RQII

Training (Iteration)	Research Question	Result
ET4ET ₁ (Iteration 1)	RQ1.1. What are the perceived changes in teaching practices as a result of the workshop?	Participants show higher perception to use active learning strategies
ET4ET ₂ (Iteration 2)	RQ2.2: What is the perception among the participants on their use of wiki and screencast in their own practice after the ET4ET ₁ training?	73.6% of respondents have positive perceptions of learning wiki, 88.2% of respondents have high perception of learning to design flipped classroom (using screencast) and 89.9% of respondents have high perception of incorporating active learning strategy with visualization
	RQ2.3: What impact does the ET4ET ₁ training have the perception of competence in design, implementation and evaluation of wiki-based activities among the participants	51.9% of the respondents feel competent to teach using wiki independently while 50.4% of respondents require assistance in designing lessons using wiki
ET4ET ₃ (Iteration 3)	RQ 3.3: Do participants perceive an increased competence in the use of Technology after the training program?	Statistically significant change in perception of high competence among participants in the use of Wiki and Screencasts 43% of respondents were never exposed to screencasts before and 29% were never exposed to Wikis

9.1.3 Learning of participants after training

The learning of participants was evaluated by analysing their technology integration lesson plans at the end of the training. Table 9.3 shows the relevant research questions across the iterations that helped us in analysing the learning of the participants from the training.

Table 9.4: Summary of Results for RQ III

Training (Iteration)	Research Question	Result
ET4ET ₁	RQ1.2. How did the participants perform in the alignment and integration of modules?	Participants show improved learning in aligning instructional strategies to the learning outcomes
ET4ET ₃	RQ 3.4: Do the participants produce effective wiki integration plans during the training programme?	Participants show improved learning in aligning the wiki affordances with the intended learning outcomes.

9.1.4 Behaviour of participants after training

The behaviour of participants after training was evaluated in ET4ET₃ (Iteration 3, RQ 3.7). This was collected through an open-ended survey that asked them to detail the changes that they felt in their practice after attending the training. Analysis of the open-ended survey revealed that changes have been obtained at three different levels – Student, Teacher and Institution. Participants observed that, after incorporating strategies learnt during the training, there is a positive attitude among their students towards teaching-learning. Individually they were experiencing a positive shift to student-centered learning among themselves. A few participants were creating similar changes within their institution by training other faculty in the institution.

9.1.5 Sustainability of Training

We have evidences of medium term sustainability of training benefits. These results are summarized in Table 9.5 below.

Table 9.5: Summary of results related to RQ V

Training (Iteration)	Research Question	Result
ET4ET ₃	RQ 3.5: How pertinent is the ET4ET ₂ programme? RQ 3.6: How immersive is the ET4ET ₂ programme?	The training is highly pertinent and immersive. The high engagement and relevance in the training can be used as a substitute indicator of sustainability.
ET4ET ₄	RQ 4.1: What changes were observed in the ownership of problem from trainer to the teacher over the course of training?	Through action research, transfer of ownership shifts completely to the participant teacher Teachers involved in dissemination of results through publication of their classroom action research results in peer reviewed conferences.

.The training benefits were seen to be present even after a semester and training in classroom action research (in the investigate phase) provided a complete transfer of ownership of the problem of technology integration to the participating teacher.

In the next section, the detailed interpretations of these results have been provided.

9.2 Interpretation of Results

- Comparable participation and perception rates with other large-scale programmes

In many large-scale programmes such as MOOCs, it is seen that as the course progresses, the attrition increases and typical completion rates are around 13% (Jordan, 2014). Academicians have coined this as the funnel of participation (Clow, 2013) and have mentioned that funneling occurs right from stage of awareness about the program till its completion. Across Iterations 2 to 5, we have seen that the completion rates were either similar or higher. A possible reason for higher participation and completion rates can be the use of adaptation active learning strategies compared to the fully online delivery of MOOCs. Within the blended mode, the synchronous remote classrooms (SRC) facilitated the development of a sense of community among participants that is crucial not just for persistence but also for commitment towards group goals, cooperation and learner motivation (Rovai, 2002). Also the use of Active Learning strategies ensured that the participants are engaged in meaningful tasks that facilitate deeper learning (Meltzer & Thornton, 2012).

- Design feature of Immersivity significant contributor to perception of technology competence

The design principle of Immersivity has ensured that participants are engaged in meaningful learning activities with technology (Howland et. al, 2012) much before learning about the specifics of the technology. The results from Iteration 2 and 3 have shown that there is a high perception of technology competence among participants from mere knowledge of technology to use of . This perception was shown by both novices and familiar users of the technology equally. A major training need was the ability to cater to diverse audience. The results of perception of technology competence reported in Iteration 3 show that both novices and experienced users of the technology have found the training to be effective.

- Higher rates of pertinency of pedagogic practices

The results show that there is a higher pertinency for pedagogic practices compared to technology-based practices. Since the context of our intervention involves training in

resource constrained and instructor-mediated classrooms (Banerjee & Murthy, 2015), this is expected. However, the positive results to technology competency coupled with higher pertinency in student-centered pedagogic practices leads us to believe that participant teachers will be integrating technology with student-centered practices once they feel comfortable with the technology (Rienties et. al, 2012). Additionally, the use of supportive scaffolds like activity constructors during training forces participant teachers to think of student-centered strategies aiding this process further.

- Diffusion of effective technology integration practices at scale to aid sustainability

The diffusion of innovation model (Rogers, 2003) mentions four elements that influence spread and sustenance of new idea – innovation itself, communication channels, time, and a social system. The iterations of A2I2 over the past three years, along with development of four portals for dissemination has ensured that three of these elements are already in place for diffusion of effective technology integration practices among the teachers and its sustainability.

9.3 Implications of Results

These results have implications for 4 types of audiences:

Researchers

To the research community the following points from our results will be of great interest:

- a. Implementing Immersivity of learning environment through adaptation of active learning strategies. The adaptation of active learning in SRC mode and use of LeD Videos, LbD activities and Practice based discussion forum can further be explored by researchers to further formalize the characteristics of the design feature that aids learner engagement and positive training benefits.
- b. The discussion forum design in the TPD MOOC (Iteration 5) will be of interest to the researchers to understand the specific facilitators and inhibitors for engagement in massive open online setting.

Trainers and Administrators

Trainers and administrators are the set of people who are going to be benefitted more from the tangible aspects of the research. The implications of the results to them are:

- a. Trainers to design teacher-training programmes can use the validated A2I2 model.
- b. Trainers of technology integration programmes can make use of the training resources that have been developed in this research. Specifically the activity constructors can be used within their training programmes to scaffold the participants.
- c. Administrators can use the outputs specified at each phase of A2I2 to cross check the effectiveness of training.
- d. Administrators can also provide facilitating conditions for emergence of communities of practice both during and after implementation of training programmes. The use of A2I2 based training by an institution (Mistry et. al, 2016) is a good example for this.

Teachers

Teachers are the major beneficiaries of A2I2 based training programmes. The results summarized in 91 have the following implication for teachers:

- a. Attending A2I2 based training will help teachers in shifting their attitudes and beliefs towards learner-centeredness
- b. Teachers will benefit from the supportive scaffolds developed during the design of A2I2 model based training programmes.
- c. As seen in blended online and massive open online implementations, formation of groups becomes essential to reap lasting benefits from training programmes.

Technology Developers

The results have the following implications for classroom-based technology developers:

- a. Design online A2I2 based training modules for their technology dissemination at scale

- b. Devise supportive scaffolds for their technology that will assist teachers while using the new technology
- c. Technology developers should ensure Immersivity in the learning environment for effective training of teachers in integration of technology in classroom.

9.4 Claims and Evidence

The following are the claims made in this research:

- A2I2 is an effective model for designing training programmes for teacher technology integration

In order to improve effectiveness of technology integration, it is desirable to use the features of technology in a student-centered manner (Banerjee, Murthy & Iyer, 2015; Howland et. al, 2012). Results of perception survey across Iteration 1-5 indicate that participants undergoing A2I2 based training show significant attitude shift towards learner-centered practice. The perception of improvement in the competency of integrating technology tools was statistically significant in iteration 3. There is also evidence of learning exhibited by participants, as seen from lesson plan evaluation in Iteration1 (Mean score of 1.76 out of 3) and wiki plan evaluations in Iteration 3 (Mean 1.8 out of 3).

- A2I2 based training programmes are scalable

The training programmes designed based on A2I2 has been implemented in face-to-face (1 time), blended online (3 times) and pure online settings (1 time).

- Immersivity and Pertinency are essential for scaling training programmes

In iteration 3, where we made explicit design modifications based on design principles of Immersivity and Pertinency, we have seen that there is high engagement of participants in the learning environment (87.8% of active remote center participation in Iteration 3, 34.8% active participation in Iteration 5). Participants also showed high perceptions of relevance and intention to apply the various strategies learnt during the training. The persistence rates (20.8% in Iteration 2, 15.6% in

Iteration 3 and 36.6% in Iteration 5) of these training programmes were found to be higher than those seen in similar large-scale courses or programmes.

- Pertinency essential for medium-term sustainability while Transfer of ownership essential for longer term sustainability

The high pertinency of the training content had led an institution to form different professional learning communities based on strategies discussed in the training (Mistry et. al., 2016). After iterations 2 and 3, there have been two instances of a few participants conducting in-house training programmes for remaining faculty in the institution. These were shared with us through the open-ended feedback administered at the end of semester. Evidences of transfer of ownership were shown during iteration 4, as we saw 7 participants engaging in classroom action research and trying to disseminate the results through international conferences.

9.5 Generalizability

- Currently we have designed and developed training modules for content creation (screencast), content curation (wiki) and content facilitation (visualization) technologies. Based on the results from the five iterations, we argue that the model will be suitable for designing training programmes for technologies that fall under any of these three categories.
- The model has been implemented in three different modes (face-to-face, blended online and massive open online) that cover the spectrum of learning environments with synchronous trainer presence to asynchronous trainer presence. This helps us in arguing that A2I2 model is scalable model for design and implementation of teacher technology integration programmes.
- A2I2 model is based on the constructive alignment (Biggs, 1996) and utilizes active learning strategies in its implementation. Since both these are valid for learners at every level, we argue that A2I2 model will be suitable for designing teacher technology integration training programmes at every level, especially at school level.

9.6 Limitations

The following are the major limitations of the study:

- A major limitation of this study is that the content mastery of the participants has been assumed and this has not been verified at the start of training. The content mastery of the participant is required for identifying various learner misconceptions about the topic being dealt in the class and designing effective pedagogic strategies to overcome them. Thus by assuming content mastery, we expect the participating teachers to have targeted their lesson designs to cater to the student misconceptions. In future one way of removing this limitation is by keeping domain specific technology integration training where participants are required to complete a pre-test on the domain concepts.
- Another limitation is that we have used participants' self-reported data on perception and practice. Research shows that espoused beliefs and actual practice can have wide variations due to contextual constraints (Lim and Chai, 2008). One way of overcoming this limitation in future work would be to use more of learning data to supplement the perception and practice.
- Researchers have not observed actual implementation of the strategy in classroom; hence the quality of actual practice (of people who have not disseminated via action research) is unknown. The implementation fidelity of active learning strategies, resulting in teachers going back to instructor-led practices after training is a known issue. One possible way of overcoming this in future work is to sample the participants and conduct in-class observations of the technology integration practices.
- There have been only a few secondary implementations that made use of the model (Mavinkurve, Patil & Narayana, 2016). To increase the secondary implementations, wider dissemination of the model has to take place among teacher trainers and pre-service school administrators.

9.7 Recommendations

- While A2I2 can be used to create purely face-to-face programmes (such as our pilot implementation), we found that a blended approach worked better in large scale. The blended mode, especially interspersing the asynchronous

sessions with the synchronous mode, made sure that participants had enough time to reflect on their learning and practice it (via SRC activities, Moodle assignments and feedback) as well as had sufficient face-to-face interaction with their peers to keep up motivation and build a community.

- Even though A2I2 is focusing about student-centered strategies and not domain content knowledge, it is necessary that participants be able to relate to the examples used for illustration. If participants are not familiar with a topic (domain content), they find it harder to think about teaching-learning aspects of that topic, and may stop being engaged. This is especially true when the topics are at the college-level and participants are remote. Hence, it is important that the examples in sessions and worksheets should be from the participants' domain. Additionally, if participants are from diverse domains, it is difficult to find examples from these domains. So it is desirable to conduct A2I2 based training for a single domain or related domains.
- In all our training programmes, participants not only have to learn new instructional strategies but also have to come up with plans to implement these strategies in their own class. So, it is important for them to be in 'student' 'role' before they move to a 'teacher' role. For effective learning in 'student' role, the use of active learning strategies in the training program is a must. In order to adopt a strategy from the training into their own courses, it is not sufficient for participants to listen about the strategy or see it being implemented. They need to do hands-on activities required of the strategy in 'student' role, only then create instruction based on that strategy in a 'teacher' role. Moreover, such hands-on activities cannot be relegated to later lab sessions but need to be incorporated in a timely manner during discussion of a strategy. For each activity, it is useful to explicitly indicate to participants whether they are to be in 'student' role or in 'teacher' role. Not indicating the role explicitly causes mismatch of expectations.
- For each instructional strategy, it is necessary to first implement the strategy as an activity that the participants perform, before discussing the detailed explanation of the strategy. For example, before discussing Peer-Instruction as an instructional strategy, the participants are involved in Peer-Instruction activities in some previous sessions. This provides them a first-hand

experience and time to reflect on the activity itself, before going on to thinking about incorporating it in their own class.

- For each technology being introduced, it is necessary to equip participants not only with the skills to use the technology but also with the pedagogical affordances of the technology. For example, participants first learn about wiki from a student perspective by doing an assignment, followed by skills training on use and setup of wiki, as well as pedagogical affordances of wiki. This culminates in participants moving to teacher role and designing wiki assignments and evaluation rubrics for their own students.
- Sessions in the program that had a mix of individual and collaborative activities worked better than those that had only one or the other. For any activity being carried out by participants, it is useful to have a participant driven collaborative activity following an individual activity. This ensures that group work occurs and individual participants learn more.
- It is important to go beyond automated multiple-choice questions for effective learning, especially for ‘applied’ topics such as ICT integration in teaching practice. To do so when there are large numbers, it is beneficial to have rubrics for peers to evaluate each other’s work. Peer- and self-assessment using such rubrics, ensures formative assessment for participants even for large-scale programmes. What was missing, due to the scale, was individual expert feedback on participants’ work. But we found that a well-designed rubric combined with structured peer-review and closure (such as a session reviewing common mistakes) compensated for it to a large extent. The same can be implemented in an online setting through reflection spots in LeD videos along with reflective LbD activities.

Chapter 10

Thesis Contributions and Future Work

The broad problem statement that is being investigated in this thesis is: “How to improve the design and delivery of training programs to the in-service faculty in engineering education within India to enable them in effectively integrating Information and Communication Technology (ICT) tools within their teaching-learning context?” I have used the Design Based Implementation Research (DBIR) methodology to develop the Attain-Align-Integrate-Investigate (A2I2) model that has been used to design and implement large-scale technology integration training programmes. The model was used to design five training programmes and implemented in three different modes – face-to-face, synchronous remote centre mode and massive open online mode. Evaluations were done across the levels of Reaction, Learning and Behaviour as per the Kirkpatrick’s model and also along the dimension of engagement rates to ensure effectiveness of the training and hence the model. I have also observed instances of medium-term sustainability where the best practices were being diffused to a larger teaching community associated with the trained teachers.

In this chapter I will be detailing the contributions that this thesis has made to both the theory (Section 10.1.1) and practice (Section 10.1.2) of teacher professional development. The chapter will also look at three possible future directions (Section 10.2) that can be taken up to expand the knowledge based in this research area.

10.1 Contributions of the Research

10.1.1 Contributions to theory

- *A2I2 Model for design and implementation of teacher technology integration training programmes*

The A2I2 model enables training programme designers to create and implement effective technology integration training programmes for teachers. By effectiveness we refer to the measures of Reaction, Learning and Behaviour along the Kirkpatrick's levels of evaluation and additionally to the measure of Persistence rates while scaling up the programme. The detailed model is available in Chapter 5, where I explain the various elements of the model - phases, focus, content, format of activities, application of design principles. In chapters 6,7 and 8, I show how the model has been used to design training in three different modes, with detailed examples showing how the model was used in training teachers in the specific technology of wiki.

- *Design principles of Pertinency, Immersivity and Transfer of Ownership*

The design principles help in the curation of training content, organizing training environment and orienting the training practices. The design principle of Pertinency helps a training designer to select suitable examples and activities that will be immediately useful for the participant. The design principle of Immersivity ensures that the training environment provides sufficient immersion of the technology so that participating teachers can experience it as a learner first. These design principles are reusable and provide orientation towards creating scalable and sustainable training designs

- *A model for adaptation of active learning strategies in synchronous-remote mode*

The synchronous online mode, similar to web-conferencing, is a major mode used to scale training programmes in our research. The work provides a model for adapting

active learning strategies utilized in a face-to-face setting to synchronous online mode without reducing their perceived effectiveness. This model has been explained in Chapters 4 and Chapter 7.

10.1.2 Contributions to Practice

- *Activity constructors for assisting teachers in technology integration*

Activity constructors are essentially scaffolds that help teachers prepare student-centered activities and lesson designs, even after the completion of training. We (Thesis supervisors Dr. Sahana Murthy and Dr. Sridhar Iyer and I) have developed the activity constructors for Peer Instruction, Think-Pair-Share, Flipped Classrooms (using screencasts), wiki based activity design and a general Lesson Planning template for technology integration. Activity constructors were provided to the participants as training resource and is also disseminated through the training website.

- *Training resources for other trainers*

The training schedules and resources (like slides and activities) are kept in creative commons, so that other trainers can make use of them. The resources website has been widely disseminated through the various outreach channels available (facebook, twitter, mailing lists etc.)

- *Portals for building Communities of Practice*

The research has also helped in creating three portals in Wikispaces, Wordpress and Facebook platforms for engaging the community of practice. Communities of Practice are essential to target long-term sustainability of the training benefits. These platforms will be ideal for college administrators and teachers who are trying to build similar communities.

10.2 Directions for Future Work

10.2.1 Extending A2I2 for synchronous collaboration tools

The thesis has focused on training participants in asynchronous collaboration (wiki, Padlet). I suspect that the affordances provided by synchronous collaboration tools, like Realtimeboard or A-VIEW etc., would require further refinement in the model to give directions for training designers. One possible future direction for extending

A2I2 would be design of a training programme for a synchronous collaboration tool (A-VIEW as participants are more familiar). Working within the DBIR space, this extension work can develop a training module for A-VIEW using the existing A2I2 model and then use implement-evaluate-refine cycles to come up with design recommendations to improve the model

10.2.2 Exploring the application of A2I2 based training programs to extend sustainability of training benefits

The current thesis has shown medium-term sustainability of training benefits through trainings based on A2I2. However, the current results are not sufficient to inform us about the preferred duration of such training, the frequencies and the quality of follow-up efforts and the type of evaluations required to confirm sustainability. Two clear research studies can be thought of in this direction using DBIR methodology itself.

- Exploring the design decisions taken up and supports needed for A2I2 trained teachers in integrating technology in the classroom. This study can be conceived of as a collaborative RPP in which there is co-design followed by guided reflections on classroom implementation. The study would require more of classroom observations, and documentation of RPP practices.
- Extending the ‘Investigate’ phase to create large-scale training of teachers in classroom action research, similar to exploratory study 4.2.

10.2.3 Extending A2I2 model to incorporate content knowledge for developing training for novice teachers

At present, the A2I2 model assumes content expertise for the participating teachers. However this may not be always valid, particularly in the case of freshly inducted teachers. Thus one more direction of future work is about identifying the effectiveness of the model to train only novice teachers. This study can use a similar methodology as the thesis and identify possible design principles that emerge from it.

PUBLICATIONS FROM THESIS

Warriem, J, Murthy, S., & Iyer, S. (2013). *A model for active learning in synchronous remote classrooms: Evidence from a large-scale implementation*. In Proceedings of 21st International Conference on Computers in Education (ICCE 2013), Bali, Indonesia, Nov 18-22.

Warriem, J, Murthy, S., & Iyer, S. (2013) *Training in-service teachers to do action research in educational technology*. In IEEE Fifth International Conference on Technology for Education (T4E 2013), Kharagpur, Dec. 18-20.

Warriem, J, Murthy, S., & Iyer, S. (2013). *A2I: A Model for Teacher Training in Constructive Alignment for Use of ICT in Engineering Education*. In Proceedings of 22nd International Conference on Computers in Education (ICCE 2014), Nara, Japan, Nov 30- Dec 4.

Murthy, S., Iyer, S., & Warriem, J. (2015). ET4ET: A Large-Scale Faculty Professional Development Program on Effective Integration of Educational Technology. *Journal of Educational Technology & Society*, 18(3), 16-28.

Warriem, J, Murthy, S., & Iyer, S. (2015). Sustainability at Scale: Evidence from a Large Scale Teacher Professional Development Program. In Proceedings of 23rd International Conference on Computers in Education (ICCE 2015), Hangzhou, China, pp. 651-660.

Warriem, J, Murthy, S., & Iyer, S. (2016). Shifting the focus from Learner Completion to Learner Perseverance: Evidences from a Teacher Professional Development MOOC. In Proceedings of 24th International Conference on Computers in Education (ICCE 2016), Mumbai, India.

Murthy, S., Warriem, J., & Iyer, S. (2017). *Technology Integration for Student-Centered Learning: A Model for Teacher Professional Development Programs*. in Kong, S.C., Wong, T.L., Yang, M., Chow, C.F., Tse, K.H. (Eds.) *Emerging Practices in Scholarship of Learning and Teaching in a Digital Era*, 55-74.

REFERENCES

- AICTE. (2016). AICTE - Dashboard. Retrieved August 30, 2016, from All India Council for Technical Education: <http://www.aicte-india.org/dashboard/pages/dashboardaicte.php>
- Amundsen, C., & Wilson, M. (2012). Are we asking the right questions? A conceptual review of the educational development literature in higher education. *Review of Educational Research*, 82(1), 90-126.
- Anand, S., Jayahari, K. R., Bijlani, K., Vijayan, V., & Chatterjee, S. (2014, December). Pedagogy-Based Design of Live Virtual Classroom for Large-Scale Training. In Technology for Education (T4E), 2014 IEEE Sixth International Conference on (pp. 195-201). IEEE
- Angeli, C., & Valanides, N. (2009). Epistemological and methodological issues for the conceptualization, development, and assessment of ICT–TPCK: Advances in technological pedagogical content knowledge (TPCK). *Computers & Education*, 52(1), 154-168.
- Atrey, M., Parmar, M., Shiriskar, R., & Dhebar, K. (2016). T10KT: Scaling up Professional Development of Teachers - Evidences and Recommendations from Large Scale Implementation. *Learning and Teaching in Computing and Engineering*. Mumbai: IEEE.
- Avalos, B. (2011). Teacher professional development in Teaching and Teacher Education over ten years. *Teaching and Teacher Education*, 27 (1), 10-20.
- Banerjee, G., Murthy, S. and Iyer, S. (2015). Effect of Active Learning using Program Visualization in Technology Constrained College Classrooms. *Research and Practice in Technology Enhanced Learning*. (in press)
- Banilower, E. R., Heck, D., & Weiss, I. (2007). Can professional development make the vision of standards a reality? The impact of the National Science Foundation's Local Systemic Change Through Teacher Enhancement Initiative. *Journal of Research in Science Teaching*, 44(3), 375-395.
- Barab, S., & Squire, K. (2004). Design-based research: Putting a stake in the ground. *The journal of the learning sciences*, 13(1), 1-14.
- Bernard, R. M., Abrami, P. C., Borokhovski, E., Wade, A. C., Rana, T. M., Surkes, M. A., & Bethe, E. C. (2009). A Meta- Analysis of Three Types of Interaction Treatments in Distance Education. *Review of Educational Research*, 1243-1289.
- Biggs, J. (1996). Enhancing Teaching through Constructive Alignment. *Higher Education*, 32, 347-264.
- Birman, B. F., Desimone, L., Porter, A. C., & Garet, M. S. (2000). Designing professional development that works. *Educational leadership*, 57(8), 28-33.

- Borko, H. (2004). Professional development and teacher learning: Mapping the terrain. *Educational Researcher*, 33(8), 3-15.
- Boschee, J., & McClurg, J. (2003). Social Enterprise Alliance. Retrieved May 12, 2012, from http://www.se-alliance.org/better_understanding.pdf.
- Bradshaw, Pete; Gallastegi, Lore; Shohel, Mahruf and Younie, Sarah (2014). Formalised action research as an emergent form of teacher professional development. In: Conference Programme Book, p. 21.
- Braun, V., & Clarke, V. (2006). Using thematic analysis in psychology. *Qualitative research in psychology*, 3(2), 77-101
- Breault, R. A. (2010). Distilling wisdom from practice: finding meaning in PDS stories. *Teaching and Teacher Education* , 26 (3), 399-407.
- Brent, R., & Felder, R. (2003). A Model for Engineering Faculty Development. *International Journal for Engineering Education* , 19 (2), 234-240.
- Bruner, J. (1960). *The Process of Education*. Cambridge, USA: Harvard University Press.
- Bull, G., Hammond, T., & Ferster, B. (2008). Developing Web 2.0 tools for support of historical inquiry in social studies. *Computers in the Schools*, 25(3-4), 275-287.
- Calleja, G. (2007). Digital Game Involvement: A Conceptual Model. *Games and culture*, 2(3), 236-260.
- Chambers, R. (2007). *Ideas For Development*. London, UK: Earthscan Publishers.
- Cho, M.-H., & Rathbun, G. (2013). Implementing Teacher-centred Online Teacher Professional Development (oTPD) Programme in Higher Education: A Case Study . *Innovations in Education and Teaching International*, 50(2), 144-156.
- Clow, D. (2013). MOOCs and the funnel of participation. *Third International Conference on Learning Analytics and Knowledge* (pp. 185-189). ACM.
- Coburn, C. E. (2003). Rethinking Scale: Moving beyond Numbers to Deep and Lasting Change. *Educational Researcher*, 32(6), 3-12.
- Coburn, C. E., Penuel, W. R., & Geil, K. E. (2013). *Research-practice partnerships. A Strategy for Leveraging Research for Educational Improvement in School Districts*. New York: William T Grant Foundation.
- Conole, G., Dyke, M., Oliver, M., & Seale, J. (2004). Mapping pedagogy and tools for effective learning design. *Computers & Education*, 43(1), 17-33.
- Desimone, L. M. (2009). Improving impact studies of teachers' professional development: Toward better conceptualizations and measures. *Educational researcher*, 38(3), 181-199.

- DEZA—Direktion für Entwicklungshilfe und Zusammenarbeit. (2002). Glossar deutsch (German glossary). Bern: DEZA
- DuFour, R. (2004). Schools as Learning Communities. *Educational Leadership*, 61 (8), 6-11.
- Ebert-May, D., Derting, T. L., Hodder, J., Momsen, J. L., Long, T. M., & Jardeleza, S. E. (2011). What we say is not what we do: effective evaluation of faculty professional development programs. *BioScience*, 61(7), 550-558.
- Emerson, J. D., & Mosteller, F. (2000). Development programs for college faculty: Preparing for the twenty-first century. In R. Branch, & M. A. Fitzgerald, *Educational media and technology yearbook 2000* (Vol. 25, pp. 26-42). Englewood, CO: Libraries Unlimited Inc.
- Ertmer, P. A. (1999). Addressing first- and second-order barriers to change: strategies for technology integration. *Educational Technology Research and Development*, 47(4), 47-61.
- Ertmer, P. A. (2005). Teacher pedagogical beliefs: The final frontier in our quest for technology integration? *Educational Technology Research and Development*, 53(4), 25-39.
- Ertmer, P. A., Ottenbreit-Leftwich, A. T., Sadik, O., Sendurur, E., & Sendurur, P. (2012). Teacher beliefs and technology integration practices: A critical relationship. *Computers & Education*, 59(2), 423-435.
- Eseryel, D. (2002). Approaches to evaluation of training: Theory & practice. *Educational Technology & Society*, 5(2), 93-98.
- Evans, L. (2002). What is Teacher Development. *Oxford Review of Education*, 28(1), 123-137.
- Fishman, B. J., Penuel, W. R., Allen, A.-R., Cheng, B. H., & Sabelli, N. O. (2013). Design-Based Implementation Research: An emerging model for transforming the relationship of research and practice. *National Society for the Study of Education*, 112(2), 136-156.
- Fox, R., & Henri, J. (2005). Understanding teacher mindsets: IT and change in Hong Kong schools. *Educational Technology & Society*, 8(2), 161-169.
- Friedman, A., & Kajder, S. (2006). Perceptions of beginning teacher education students regarding educational technology. *Journal of Computing in Teacher Education*, 22(4), 147-151.
- Garet, M. S., Porter, A. C., Desimone, L., Birman, B. F., & Yoon, K. S. (2001). What makes professional development effective? Results from a national sample of teachers. *American educational research journal*, 38(4), 915-945.
- Gibbs, G. (1988). *Learning by doing: a guide to teaching and learning method*. Oxford: Further Education Unit, Oxford Press.
- Gibbs, G., & Coffey, M. (2004). The impact of training of university teachers on their teaching skills, their approach to teaching and the approach to learning of their students. *Active*

Learning in Higher Education, 5(1), 87–100

- Greenhow, C., Robelia, B., & Hughes, J. E. (2009). Learning, teaching, and scholarship in a digital age Web 2.0 and classroom research: What path should we take now? *Educational Researcher*, 38(4), 246-259.
- Guskey, T. R., & Yoon, K. S. (2009). What works in professional development?. *Phi delta kappan*, 90(7), 495-500.
- Harden, R. M. (1999). What is a spiral curriculum?. *Medical teacher*, 21(2), 141-143.
- Harris, J.B., & Hofer, M.J. (2009). Instructional planning activity types as vehicles for curriculum-based TPACK development. In C. D. Maddux (Ed.), *Research highlights in technology and teacher education*. 2009 (pp. 99–108). Chesapeake, VA: AACE.
- Harris, J. B., & Hofer, M. J. (2011). Technological pedagogical content knowledge (TPACK) in action: A descriptive study of secondary teachers' curriculum-based, technology-related instructional planning. *Journal of Research on Technology in Education*, 43 (3), 211–229.
- Hayes, N. (2000). *Doing psychological research*. Taylor & Francis Group.
- Henderson, C., Beach, A., & Finkelstein, N. (2011). Facilitating change in undergraduate STEM instructional practices: An analytic review of the literature. *Journal of research in science teaching*, 48(8), 952-984.
- Hennessy, S., Ruthven, K., & Brindley, S. (2005). Teacher perspectives on integrating ICT into subject teaching: Commitment, constraints, caution, and change. *Journal of Curriculum Studies*, 37(2).
- Herman, J. H. (2012). Faculty Development Programs: The frequency and variety of professional programs available to online instructors. *Journal of Asynchronous Learning Networks*, 16(5), 87-106.
- Hew, K. F., & Brush, T. (2007). Integrating technology into K-12 teaching and learning: Current knowledge gaps and recommendations for future research. *Educational Technology Research and Development*, 55(3), 223-252.
- Howland, J. L., Jonassen, D. H., & Marra, R. M. (2012). *Meaningful learning with technology*. Upper Saddle River, NJ: Pearson.
- Hutchings, P., & Schulman, L. S. (1999). The Scholarship of Teaching: New elaborations, new developments. *Change: The Magazine of Higher Learning*, 31(5), 10-15.
- IITBombayX. (2016). IITBombayX. Retrieved May 06, 2017, from <https://www.iitbombayx.in/>
- IT@School. (2001). Home: IT@School. Retrieved December 21, 2016, from IT@School: <https://www.itschool.gov.in/>

- Jaffee, D. (1997). Asynchronous Learning: Technology and Pedagogical Strategy in a Distance Learning Course. *Teaching Sociology*, 262-277.
- Jobe, W., Östlund, C., & Svensson, L. (2014). MOOCs for professional teacher development. In *Society for Information Technology & Teacher Education International Conference*, Mar 17, 2014 in Jacksonville, Florida, United States (pp. 1580-1586). AACE
- Johns, C. (2006). *Engaging Reflection in Practice: A narrative approach*. Oxford, UK: Blackwell Publishing.
- Jonassen, D., Howland, J., Marra, R., & Crismond, D. (2008). *Meaningful learning with technology*. Upper Saddle River, New Jersey, USA: Pearson Education, INc.
- Jonassen, D., Strobel, J., & Lee, C. B. (2006). Everyday problem solving in engineering: Lessons for engineering educators. *Journal of Engineering Education*, 95(2), 139-151.
- Jordan, K. (2001). MOOC Project. Retrieved May 5, 2013, from www.katyjordan.com/MOOCProject.html
- Joyce, S. (2014). *Supervising the reflective practitioner: An essential guide to theory and practice*. New York: Routledge.
- Kannan, K., & Narayanan, K. (2010). ICT enabled teacher training for Human capital formation: A study of IIT Bombay initiative. *International conference on Science, Technology and Economy: Human capital development* (pp. 11-12). Mumbai: IASSI.
- Kannan, K., & Narayanan, K. (2011). Model and Learner Feedback for a Large Scale Technology Enabled Teacher Training Program. *Technology for Education (T4E), IEEE International Conference on* (pp. 250-253). Mumbai: IEEE.
- Kirkpatrick, D. L. (1998). *Evaluating training programs: the four levels*. Philadelphia: Berrett-Koehler
- Koehler, M., & Mishra, P. (2009). What is technological pedagogical content knowledge (TPACK)?. *Contemporary issues in technology and teacher education* , 6 (1), 60-70.
- Koehler, M. J., Shin, T. S., & Mishra, P. (2012). How do we measure TPACK? Let me count the ways. In *Educational technology, teacher knowledge, and classroom impact: A research handbook on frameworks and approaches* (pp. 16-31). IGI Global.
- Koehler, M. J., Mishra, P., Kereluik, K., Shin, T. S., & Graham, C. R. (2014). The technological pedagogical content knowledge framework. In *Handbook of research on educational communications and technology* (pp. 101-111). Springer New York.
- Kolb, D. A. (1984). *Experiential learning: Experience as the source of learning and development*. Englewood Cliffs: Prentice Hall.
- Kozma, R. B., & Vota, W. S. (2014). ICT in developing countries: Policies, implementation, and impact. In *Handbook of research on educational communications and technology*(pp.

- 885-894). Springer, New York, NY.
- Laakso, M. J., Myller, N., & Korhonen, A. (2009). Comparing Learning Performance of Students Using Algorithm Visualizations Collaboratively on Different Engagement Levels. *Educational Technology & Society*, 12(2), 267-282.
- Laakso, M.-J., Myller, N., & Korhonen, A. (2009). Comparing Learning Performance of Students Using Algorithm Visualizations Collaboratively on Different Engagement Levels. *Educational Technology & Society*, 12(2), 267-282.
- Laurillard, D. (2014). Anatomy of a MOOC for Teacher CPD. Technical report. UCL Institute of Education.
- Lawless, K. A., & Pellegrino, J. W. (2007). Professional development in integrating technology into teaching and learning: Knowns, unknowns, and ways to pursue better questions and answers. *Review of Educational Research*, 77(4), 575-614.
- Levy, Y. (2007). Comparing dropouts and persistence in e-learning courses. *Computers & Education*, 48(2), 185-204.
- Lim, C. P., & Khine, M. (2006). Managing teachers' barriers to ICT integration in Singapore schools. *Journal of Technology and Teacher Education*, 14(1), 97-125.
- Lim, C. P., & Chai, C. S. (2008). Teachers' pedagogical beliefs and their planning and conduct of computer-mediated classroom lessons. *British Journal of Educational Technology*, 39(5), 807-828
- Lim, C. P., Chai, C. S., & Churchill, D. (2011). A framework for developing pre-service teachers' competencies in using technologies to enhance teaching and learning. *Educational Media International*, 48(2), 69-83.
- Loucks-Horsley, S., Stiles, K. E., Mundry, S., & Hewson, P. W. (Eds.). (1996). *Designing professional development for teachers of science and mathematics*. Corwin Press.
- Lyman, F. "The Responsive Class Discussion." In A. S. Anderson (ed.), *Mainstreaming Digest*. College Park: College of Education, University of Maryland, 1981
- Margaryan, A., Bianco, M., & Littlejohn, A. (2015). Instructional quality of massive open online courses (MOOCs). *Computers & Education*, 80, 77-83.
- Mavinkurve, M., Narayana, S., & Patil, M. (2016). Exploring effects of immersivity across three dimensions in training design. In Proceedings of 24th International Conference on Computers in Education (ICCE2016), Mumbai, India.
- McShannon, J., & Hynes, P. (2005). Student achievement and retention: Can professional development programs help faculty GRASP it? *Journal of Faculty Development*, 20(2), 87-94.
- Mehta, G., Pawar, R. S., Kincha, H. P., Gautam, V., & Bandyopadhyay, D. K. (2012). Report

- of the Evaluation Committee on NMEICT. Retrieved February 15, 2017, from Sakshat: http://www.sakshat.ac.in/Document/NMEICT_Evaluation_Report.pdf
- Meltzer, D. E., & Thornton, R. K. (2012). Resource letter ALIP-1: active-learning instruction in physics. *American journal of physics*, 80(6), 478-496.
- Mettetal, G. (2012). The what, why and how of classroom action research. *Journal of the Scholarship of Teaching and Learning*, 2(1), 6-13.
- MHRD. (2009). NMEICT Mission Document. Retrieved October 3, 2016, from Saakshaat: <http://www.sakshat.ac.in/document/Missiondocument.pdf>
- MHRD. (2014, June 13). NMEICT Achievements. Retrieved August 20, 2015, from Sakshat: <http://www.sakshat.ac.in/Document/Achievements.pdf>
- Mills, G. E. (2000). *Action Research: A Guide to Teacher Researcher*. New Jersey: Prentice-Hall.
- Milman, N. B., Kortecamp, K., & Peters, M. (2007). Assessing teacher candidates' perceptions and attributions of their technology competencies. *International Journal of Technology in Teaching and Learning*, 3(3), 15-35.
- Mishra, P., Koehler, M. J., & Kereluik, K. (2009). Looking back to the future of educational technology. *TechTrends*, 53(5), 49.
- Moore, M. G. (2007). The Theory of Transactional Distance. In M. G. Moore, *The Handbook of Distance Education*. Second Edition (pp. 89-108). Mahwah, N.J: Lawrence Erlbaum Associates.
- Mouza, C. (2009). Does research-based professional development make a difference? A longitudinal investigation of teacher learning in technology integration. *Teachers College Record*, 111(5), 1195-1241.
- Murphy, C., & Martin, S. N. (2015). Coteaching in Teacher Education: Research and Practice. *Asia-Pacific Journal of Teacher Education*, 43 (4), 277-280.
- Murthy, S., & Iyer, S. (2013). *Guidelines and Templates for Planning, Conducting and Reporting Educational Technology Research*. Technical Report, Indian Institute of Technology Bombay, IDP in Educational Technology, Mumbai.
- National Knowledge Commission. (2009). *Report to the Nation 2006-2009*. Government of India. New Delhi: National Knowledge Commission.
- National Knowledge Commission. (2015). *NKC Reports*. Retrieved October 3, 2016, from NKC: <http://knowledgecommissionarchive.nic.in/downloads/report2009/eng/report09.pdf>
- NITTRC. (2013). NITTRC. Retrieved May 6, 2017, from Home: <http://www.nitttrc.ac.in/>
- NMEICT. (2013). NMEICT. Retrieved May 6, 2017, from Home page:

<http://www.it.iitb.ac.in/nmeict/home.html>

- Norton, L. S. (2009). Action research in teaching and learning: A practical guide to conducting pedagogical research in universities. Routledge.
- Pal, Y. (1993). Report of "The Committee to Advise on Renovation and Rejuvenation of Higher Education". Government of India. New Delhi: AICTE.
- Penuel, W. R., Fishman, B. J., Cheng, B. H., & Sabelli, N. (2011). Organizing research and development at the intersection of learning, implementation, and design. *Educational Researcher*, 40 (7), 331-337.
- Phatak, D. B. (2015). Adopting MOOCs for quality engineering education in India. *Proceedings of the International Conference on Transformations in Engineering Education* (pp. 11-23). Springer India.
- Plomp, T. (2013). Educational Design Research: An Introduction. In T. Plomp, & N. Nieveen (Eds.), *Educational Design Research - Part A: An Introduction* (pp. 10-51). Enschede, the Netherlands: SLO.
- Prince, M. (2004). Does active learning work? A review of the research. *Journal of Engineering Education*, 93(3), 223-231.
- Prince, M. (2004). Does active learning work? A review of the research. *Journal of Engineering Education*, 93(3), 223-231.
- Prince, M. J., & Felder, R. M. (2006). Inductive Teaching and Learning Methods: Definitions, Comparisons, and Research Bases. *Journal for Engineering Education*, 95(2), 123-138.
- Rienties, B., Brouwer, N., & Lygo-Baker, S. (2013). The effects of online professional development on higher education teachers' beliefs and intentions towards learning facilitation and technology. *Teaching and Teacher Education*, 29, 122-131.
- Riess, W., & Mischo, C. (2010). Promoting systems thinking through biology lessons. *International Journal of Science Education*, 32(6), 705-725.
- Riess, W., & Mischo, C. (2010). Promoting systems thinking through biology lessons. *International Journal of Science Education*, 32(6), 705-725.
- Robins, C. (2003). *Curious lessons in the museum: the pedagogic potential of artists' interventions*. Ashgate Publishing, Ltd..
- Rock, T. C., & Levin, B. B. (2002). Collaborative Action Research Projects: Enhancing Preservice Teacher Development in Professional Development Schools. *Teacher Education Quarterly*, 29 (1), 7-21.
- Runhaar, P., Sanders, K., & Yang, H. (2010). Stimulating teachers' reflection and feedback asking: an interplay of self-efficacy, learning goal orientation, and transformational

- leadership. *Teaching and Teacher Education*, 26 (5), 1154-1161.
- Sagor, R. (2000). *Guiding School Improvement with Action Research*. Alexandria, VA: ASCD.
- Saroyan, A., & Amundsen, C. (2004). *Rethinking teaching in higher education: From a course design workshop to a faculty development framework*. Stylus Publishing, LLC..
- Saroyan, A., Amundsen, C., McAlpine, L., Weston, C., Winer, L., & Gandell, T. (2004). Assumptions underlying workshop activities. *Rethinking teaching in higher education*, 15-32.
- Schaefer, D., & Utschig, T. (2008). *A Review of Professional Qualification, Development, and Recognition of Faculty Teaching in Higher Education around the World*. 2008 American Society for Engineering Education (ASEE) Annual Conference and Exposition. Washington: ASEE.
- Schaefer, D., & Utschig, T. (2008). *A Review of Professional Qualification, Development, and Recognition of Faculty Teaching in Higher Education around the World*. 2008 American Society for Engineering Education (ASEE) Annual Conference and Exposition. Washington: ASEE.
- Schagler, M. S., Fusco, J., & Schank, P. (2004). Evolution of an Online Education Community of Practice. In K. A. Renninger, & W. Shumar, *Building Virtual Communities: Learning and Change in Cyberspace* (pp. 129-158). Cambridge, UK: Cambridge University Press.
- Schoen, D. (1987). *Educating the Reflective Practitioner*. SanFrancisco: Josey-Bass Publishers.
- Selwyn, N. (2007). The use of computer technology in university teaching and learning: a critical perspective. *Journal of Computer Assisted Learning*, 23(2), 83-94.
- Shaffer, C. A., Akbar, M., Alon, A. J. D., Stewart, M., & Edwards, S. H. (2011, March). Getting algorithm visualizations into the classroom. In *Proceedings of the 42nd ACM technical symposium on Computer science education* (pp. 129-134). ACM.
- Sherman, W. R., & Craig, A. B. (2002). *Understanding virtual reality: Interface, application, and design*. Elsevier
- Shuman, L. J., Besterfield-Sacre, M., & McGourty, J. (2015). The ABET “Professional Skills” – Can They Be Taught? Can They Be Assessed? *Journal of Engineering Education*, 94(1), 41-55.
- Smith, A. J. (1990). The task of the referee. *IEEE computer*, 23(4), 65-71.
- Spiezia, V. (2011). Does computer use increase educational achievements? Student-level evidence from PISA. *OECD Journal: Economic Studies*, 2010(1), 1-22.
- Steinert, Y., Mann, K., Centeno, A., Dolmans, D., Spencer, J., Gelula, M., et al. (2006). A systematic review of faculty development initiatives designed to improve teaching

- effectiveness in medical education: BEME Guide No. *Medical Teacher*, 28(8), 497–526
- Stes, A., Min-Leliveld, M., Gijbels, D., & Van Petegem, P. (2010). The impact of instructional development in higher education: The state-of-the-art of the research. *Educational research review*, 5(1), 25-49.
- Streveler, R., Smith, K. A., & Pilotte, M. (2012). Aligning course content, assessment, and delivery: Creating a context for outcome-based education. In K. M. Yusof, S. Mohammad, N. A. Azli, M. N. Hassan, A. Kosnin, & S. Y. S. K., *Outcome-Based Education and Engineering Curriculum: Evaluation, Assessment and Accreditation*. Hershey, Pennsylvania, USA: IGI Global.
- Supovitz, J. A., & Turner, H. M. (2000). The effects of professional development on science teaching practices and classroom culture. *Journal of Research in Science Teaching*, 37(2), 963-980.
- T10kT. (2012). About T10kT. Retrieved December 20, 2016, from T10kT: http://www.it.iitb.ac.in/nmeict/About_T10kT.html
- Trentin, G. (2006). The Xanadu project: training faculty in the use of information and communication technology for university teaching. *Journal of computer assisted learning*, 22(3), 182-196.
- Triggs, P., & John, P. (2004). From transaction to transformation: information and communication technology, professional development and the formation of communities of practice. *Journal of computer assisted learning*, 20(6), 426-439.
- Trigwell, K., & Posser, M. (2014). Qualitative variation in constructive alignment in curriculum design. *Higher Education*, 67 (2), 141-154.
- Tsai, C.-C., & Chai, C. S. (2012). The “third”-order barrier for technology-integration instruction: Implications for teacher education. *Australasian Journal of Educational Technology*, 28(6), 1057-1060.
- Tseng, F. C., & Kuo, F. Y. (2014). A study of social participation and knowledge sharing in the teachers' online professional community of practice. *Computers & Education*, 72, 37-47.
- University Grants Commission. (2007). Guidelines for ASC. Retrieved June 17, 2016, from UGC: <http://www.ugc.ac.in/oldpdf/xiplanpdf/academicstaff.pdf>
- University Grants Commission. (2010, June 30). UGC Reports. Retrieved August 28, 2016, from UGC: http://www.ugc.ac.in/oldpdf/regulations/revised_finalugcregulationfinal10.pdf
- Uysal, H. H. (2012). Evaluation of an In-Service Training Program for Primary-School Language Teachers in Turkey. *Australian journal of teacher education*, 37(7), n7
- Van den Akker, J., Gravemeijer, K., McKenney, S., & Nieveen, N. (2006). *Educational Design*

- Research. Routledge. Kopcha, T. J., Schmidt, M. M., & McKenney, S. (2015). "Editorial" special issue on educational design research (EDR) in post-secondary learning environments. *Australasian Journal of Educational Technology*, 31(5), I-IX.
- Venkatesh, V., & Davis, F. D. (2000). A theoretical extension of the technology acceptance model: Four longitudinal field studies. *Management science*, 46(2), 186-204.
- Vescio, V., Ross, D., & Adams, A. (2008). A review of research on the impact of professional learning communities on teaching practice and student learning. *Teaching and Teacher Education*, 24(1), 80-91.
- Wang, X., Su, Y., Cheung, S., Wong, E., & Kwong, T. (2013). An exploration of Biggs' constructive alignment in course design and its impact on students' learning approaches. *Assessment and Evaluation in Higher Education*, 38(4), 477-491.
- Wankat, P., Felder, R., Smith, K., & Oreovicz, F. (2002). The scholarship of teaching and learning in engineering. In *Disciplinary styles in the scholarship of teaching and learning: Exploring common ground*. Washington, D.C: American Association for Higher Education and the Carnegie Foundation for the Advancement of Teaching.
- Wastiau, P., Blamire, R., Kearney, C., Quittre, V., Gaer, E. V., & Monseur, C. (2013). The use of ICT in education: a survey of schools in Europe. *European Journal of Education*, 48(1), 11-27.
- Wenger, E. (1998). *Communities of Practice: Learning, meaning and identity*. Cambridge, UK: Cambridge University Press.
- Williams, D., Coles, L., Wilson, K., Richardson, A., & Tuson, J. (2000). Teachers and ICT: current use and future needs. *British Journal of Educational Technology*, 31(4), 307-320.
- Windschitl, M., & Sahl, K. (2002). Tracing teachers' use of technology in a laptop computer school: The interplay of teacher beliefs, social dynamics, and institutional culture. *American Educational Research Journal*, 39(1), 165-205.
- Wohlin, C. (2014). Guidelines for Snowballing in Systematic Literature Studies and a Replication in Software Engineering. *International Conference on Evaluation and Assessment in Software Engineering 2014* (pp. 38-47). London: ACM.
- Yang, D., Sinha, T., Adamson, D., & Rose, C. (2013). Turn on, tune in, drop out: Anticipating student dropouts in massive open online courses. *2013 NIPS Data-Driven Education Workshop*.
- Yang, S. (2009). Using blogs to enhance critical reflection and community of practice. *Journal of Educational Technology & Society*, 12 (2), 11-21.
- Zhao, Y., Pugh, K., Sheldon, S., & Byers, J. (2002). Conditions for classroom technology innovation. *Teachers College Record*, 104(3), 482-515.

APPENDICES

APPENDIX A – Worksheets for Iteration 1_{f2f}

WORKSHEET 1.B.1

INSTRUCTIONS

1. *Please write your name in the space provided*
2. *Make sure that your answers are concise to fill the space provided.*
3. *The first three columns should be filled as part of Activity 1 and the last column has to be filled as part of Activity 4*
4. *In case of queries please take help of Workshop TA's*

<i>Topic</i>	<i>Lecture Plan</i>	<i>Your Objective</i>	<i>Learning Objective</i>

WORKSHEET 1.B.2

INSTRUCTIONS

1. *Please write your name in the space provided*
2. *Make sure that your answers are concise to fill the space provided.*
3. Initially fill up against the topic provided before moving onto your choice of topic
4. *In case of queries please take help of Workshop TA's*

Topic	Chunks within Topic	What will Student be Able To DO?	Expected Outcome	Learning Objective
Combinational CIRCUITS OR ARRAYS OR <hr/>				

WORKSHEET 1.B.3

Learning Objective	How will you Structure Content and What is the Plan of Execution?	Assessment Question

WORKSHEET 1.C.1

INSTRUCTIONS

1. *Please write your name in the space provided*
2. *Make sure that your answers are concise to fill the space provided.*
3. *In case of queries please take help of Workshop TA's*

Details of Teaching Task	Factors considered	Teaching strategy proposed
<p><u>Third year CS</u> students need to understand Dijkstra algorithm, which is often used in routing as a subroutine in other graph algorithms, or in GPS technology. Dijkstra's algorithm, is a graph search algorithm that solves the single-source <u>shortest path problem</u>.</p>	From teacher's perspective	
	From students' perspective	

Details of Teaching Task	Factors considered	Teaching strategy proposed
<p>One of the topics from a course on ‘Integrated Circuits’ for Second year engineering students of Electrical Engineering is 555 Timer IC. 555, being a versatile IC, as an instructor you want students to <u>develop expertise in designing circuits for different applications using IC 555.</u></p> <p>The course has a lab component wherein students will be assessed on the basis of a ‘mini-project’; Students should design and develop any application/ small product that uses IC 555.</p>	From teacher's perspective	
	From students' perspective	
	Any other issue considered	

Details of Teaching Task	Factors considered	Teaching strategy proposed
<p>You are a mathematics teacher and are teaching to <u>second year students</u> the topic “<u>Fourier Transform</u>”. You expect students to do numerical calculations and find out Fourier transform for a given function. You want students to understand how to apply Fourier Transform properties to solve numerical.</p>	<p>From teacher's perspective</p>	
	<p>From students' perspective</p>	
	<p>Any other issue considered</p>	

Details of Teaching Task	Factors considered	Teaching strategy proposed
<p>Scenario of Your Choice:</p>	<p>From teacher's perspective</p>	
	<p>From students' perspective</p>	
	<p>Any other issue considered</p>	

WORKSHEET 1.D.2

INSTRUCTIONS

1. *Please write your name in the space provided*
2. *Make sure that your answers are concise to fill the space provided.*
3. *In case of queries please take help of Workshop TA's*

Sl No	Scenario	Purpose	Assessment Method
1	Students are required to write an abstract of a research paper/article within a specified word limit e.g. 300–500 words		
2	Students are required to make or design something, e.g. radio broadcast, video clip, web page etc as a group work exercise		
3	Before introducing a new course in the computer department, the HOD wants to know the students perception about the new course.		
4	Students are told to give a proof of their competency in java programming		
5	Students are required to perform and write a report for all practicals in a single lab book.		
6	Students are assessed on the basis of their contributions to an online discussion for example, with their peers, hosted on a virtual learning environment		
7	A faculty is interested to explore students' understanding of a wide range of topics in his course		
8	A company is interested in selecting candidates and want a deep insight into candidates perception, attitudes and skills		
9	Students are required to organize, synthesize, and clearly describe their achievements and effectively communicate what they have learned.		
10	Students are told to analyze the reasons for a poor placement record of their college and come out with various solution to improve the current situation		
11	At the end of semester students have to demonstrate the mastery and skills of applying the concepts they have studied in their course on a real world problem		

WORKSHEET 2.B.1

INSTRUCTIONS

- 1. Please write your name in the space provided*
- 2. Make sure that your answers are concise to fill the space provided.*
- 3. In case of queries please take help of Workshop TA's*

Bloom's Level	Learning Objective	Expected Outcome
RECALL		
UNDERSTAND		
APPLY		

WORKSHEET 2.C.1

INSTRUCTIONS

1. *Please write your name in the space provided*
2. *Make sure that your answers are concise to fill the space provided.*
3. *In case of queries please take help of Workshop TA's*

Sl No	Assessment Question	Blooms Level
1	Write a program to calculate standard deviation of a list of N numbers, where N and all numbers are input. Use arrays to do this.	
2	Certain memory has a capacity of 4K*8. a. How many data input lines and output lines does it have? b. How many address lines does it have? c. What is its capacity in bytes?	
3	State the DE-MORGAN's theorem for $A+B = A .B$. a. It states that the complement of a sum is equal to the product of the complements of the inputs. b. It states that the complement of a product is equal to the sum of the complements if the inputs. c. It states that the complement of a sum is equal to the product of the inputs. d. It states that the sum of the inputs is equal to the product of the complements if the inputs.	
4	How will you declare an array of integer type in C?	
5	Declare an array that can store 10 names.	
6	If the 3rd element of a 10 element array is stored at a memory location 1024 (each memory location stores 1 byte), at which location is the 6th element stored?	
7	Draw a 4-bit ring counter	
8	What is the output of the following expression? $A B + A B + A B$ 1. $A + B$ 2. $A + B$ 3. $A + B$ 4. $A + B$	

WORKSHEET 2.C.2

INSTRUCTIONS

- 1. Please write your name in the space provided*
- 2. Make sure that your answers are concise to fill the space provided.*
- 3. In case of queries please take help of Workshop TA's*

Bloom's Level	Assessment Question
RECALL	
UNDERSTAND	
APPLY	

WORKSHEET 3.A.1

INSTRUCTIONS

1. *Please write your name in the space provided*
2. *Make sure that your answers are concise to fill the space provided.*
3. *In case of queries please take help of Workshop TA's*

Bloom's Level	Learning Objective	Expected Outcome
Analyze		
Evaluate		
Create		

WORKSHEET 3.B.1

INSTRUCTIONS

1. *Please write your name in the space provided*
2. *Make sure that your answers are concise to fill the space provided.*
3. *In case of queries please take help of Workshop TA's*

Sl No	Assessment Question	Blooms Level
1	Predict the output of this code? <pre>int I,j; int count = 1; for (i =0; i<=4; i++) {printf("\n");for(j = 0; j<=I; j++){ Print("%dt", count);count++;}}</pre>	
2	Which gate can be used to get output equal to that given by following equation? $A + A.\bar{B} + \bar{A}.B$ <p>1. NOT Gate 2. OR Gate 3. AND Gate 4. NOR Gate 5. NAND Gate</p>	
3	What is the following code fragment accomplishing? Explain how. <pre>char a [] = "Goodbye"; char b [] = "Hello"; for(int i=0; ;i++){ if(a[i]=='\0' && b[i]=='\0') return '='; if(a[i]=='\0') return '<';if(b[i]=='\0') return '>'; if(a[i] < b[i]) return '<'; if(a[i] > b[i]) return '>'; }</pre>	
4	Design a system that will tell whether a particular die is "fair". Use an array of 6 integers intended to store the cumulative results of rolling a standard 6-sided die. Store the counts of how many times each number comes up.	
5	In Quicksort algorithm, prove that “randomly select an item as a pivot would make it <i>extremely</i> unlikely that worst-case behavior would occur	
6	A firm wishes to have their safe protected by an alarm at night. It must be possible to switch the alarm on and off. When ‘on’ the alarm should ring if the safe door opens and it is dark. Design a circuit for an electronics system which would operate the alarm under the conditions specified by the firm	
7	Write a program to calculate standard deviation of a list of N numbers, where N and all numbers are input. Use arrays to do this.	
8	Compare the recursive and non recursive program for finding the factorial of number in terms of lines of code, time and space complexity, ease of understanding, etc.	

WORKSHEET 3.B.2

INSTRUCTIONS

1. *Please write your name in the space provided*
2. *Make sure that your answers are concise to fill the space provided.*
3. *In case of queries please take help of Workshop TA's*

Bloom's Level	Assessment Question
ANALYZE	
EVALUATE	
CREATE	

WORKSHEET 3.C.1

INSTRUCTIONS

- 1. Please write your name in the space provided*
- 2. Make sure that your answers are concise to fill the space provided.*
- 3. In case of queries please take help of Workshop TA's*

Topic	Visualization Details/ URL	Learning Objective	How will you integrate visualization in your lecture plan

APPENDIX B – Activity Constructors developed for Iteration 2_{bo} onwards

LEARNING DESIGN TEMPLATE



Lesson Design Template is licensed under a [Creative Commons Attribution-NonCommercial-ShareAlike 4.0 International License](https://creativecommons.org/licenses/by-nc-sa/4.0/). Based on a work at [John Hopkins University](https://www.jhu.edu/).

The purpose of the Lesson Design Template (LDT) is to establish foundation for the lesson that you are planning to take within your course. This document will guide the planning, design, and development of your lesson. The LDT should be ideally updated through the course development to reflect any revisions to the course design.

1. Lesson Information

Course Number/Name: <i>Example: 605.741 Distributed Database Systems</i>	Domain: <i>Example: Computer Science Engineering</i>	Topic being dealt in the Lesson: <i>Example:</i>
Audience: <i>Example: 5th Semester CSE students</i>	Course Instructor:	Instructor Email:

2. Lesson Description

In the space below, provide the description of your course.

Example: Through this lesson, an introduction to the concept of distributed database systems is provided. The exercises included in the lesson allow students to create an example homogenous distributed database system and perform operations of read and write.

3. Lesson Learning Objectives

In the space below, provide the course learning objectives. Course learning objectives are specific and measurable statements that describe what the students will be able to do after completing this course.

Example:

By the end of this lesson, students will be able to:

- Explain theoretical principles and practical approaches to create and maintain distributed database systems.*
- Write SQL statements to perform read/write operations within a distributed database system.*
- Design a distributed database system for a company having 5 branches located at different regions in a state.*

4. Lesson Design

In the table below, replace the given example and provide the details of your lesson plan design. Make sure that you replace the example solution with your lesson plan.

<u>Lesson Learning Objectives</u>	Instructional Strategies Aligned to LO		Assessment Strategies aligned to LO	Technology Tools used along with their Purpose
	Teaching Strategies with Technology (mapped to LO)	Learning Activities with Technology (mapped to LO)		
By the end of this module, you will be able to: 1.1 – Discuss... 1.2 – Explain... 1.3 – Calculate... 1.4 – Apply...	1A: Introduction to [Topic] (1.1, 1.2) – voiceover PowerPoint presentation (Screencast)	<ul style="list-style-type: none"> The presentation is paused at __ points to allow students to discuss... (1.1) 		Screencast – Information Transmission
	1B: Calculating the... (1.3) –White board demo + Moodle Assignment	In a short TPS assignment, students are required to <ul style="list-style-type: none"> Think individually about the initial part of the calculation Pair with neighbor and refine the solution Share on the white board the various ways of arriving at initial solution (1.2) Later submit their complete solutions via Moodle(1.2) 	TPS as an assignment strategy	Whiteboard - For demonstration of calculation Moodle – Assignment Submission
	1C: Applying the		Students complete a project that	Wiki – For collaborative problem

	[Topic] to [Type of Problem] (1.4) – designing a wiki activity for collaborative problem solving		requires them to calculate...and apply [topic] to solving a scenario problem. (1.3, 1.4)	solving
--	--	--	--	---------

FLIPPED CLASSROOM ACTIVITY CONSTRUCTOR

Resource – <i>Flipped Classroom Activity constructor</i>	Version 1.0, Jul 2014
Download from: www.et.iitb.ac.in/TeachingStrategies.html	Released under: Creative Commons-Attribution 4.0 license

The resource contains guidelines for developing and implementing a flipped classroom within your course. The resource also contains an example Flipped Classroom Design which will help you to design your own flipped classrooms better. We have provided you with a sample rubric that will help you to self-assess the created out-of-class activity.

1. Identify the course and topic where you will use the flipped classroom.

Course: [Write down your course here](#)

Topic: [Write down your topic here](#)

PART 1- OUT-OF-CLASS ACTIVITIES

The following questions will help you to design the out-of-class segment within the Flipped Classroom Activity. The out-of-class segment is meant mainly for information transmission to the student. As a teacher, you can use this segment to provide the necessary knowledge to the students that will help them to achieve Lower Order Cognitive levels (within the Revised Blooms Taxonomy) without wasting valuable in-class time.

2. Identify and list learning objectives at Lower Order Thinking Skills (Recall-Understand – Apply) for this topic.

Learning Objectives

[Write Lower Order Learning Objectives here](#)

3. Resources:

a) Create/Locate video resources for achieving this Lower Order thinking skills.

[URL for video Resource](#)

(If you have created a video resource, upload them in youtube and provide the link)

Some of the popular repositories that you might want to search are:

<https://www.youtube.com/channel/UCzG3hrquhYMSevy-o-U50Bg/channels>

<http://ocw.mit.edu/courses/audio-video-courses/>

<http://nptel.ac.in/>

b) Mention Textbook/Slides or other resources that you will provide along with the video

4. Identify assessment questions to check whether the Learning Objectives have been achieved. If there are more than one video(s), then indicate when each assessment question has to be attempted

Assessment Questions

Write Lower Order Assessment Questions here

PART 2 – IN-CLASS ACTIVITY

The following questions will help you to design in-class activities that can now be focused on students assimilating the knowledge on the topic. This means that you can employ active learning strategies within your classroom that will target at improving higher order thinking skills of your students. Thus the valuable class time will be effectively used for both you and your students.

5. Instructions to the students for watching the video resource and attempting the assignment questions. As the students are watching the video outside classroom, it will always benefit them if you provide them specific instructions on how to use the video and assessment.

Write your instructions to students on how to use the video and out-of-class assessment

6. Identify and list Higher Order Thinking skills (Analyze-Evaluate-Create) that you are going to target within the in-class segment.

Write Higher Order Learning Objectives here

7. Identify a suitable Active Learning Strategy that you will use for achieving this objective. Recall that, for an activity to be truly active, the instructor should carefully design the strategy and engage students beyond mere copying of notes or following instructions.

AL Strategy:

8. If your strategy involves:

- a. PI or TPS, use the activity constructors (downloadable from www.et.iitb.ac.in/TeachingStrategies.html) to develop appropriate in-class activities.
- b. Visualization, use the QEEE workshop Online Week 3 activity constructors (ppt's) to elaborate it.
- c. Others, explain your activity by mentioning what you plan to do as instructor and what your students will do (and what technology resources will do, if any is used) at each point within the activity

9. The Assessment strategy for your in-class segment to ensure that higher order objectives are achieved.

10. Once you have completed the planning process, do a self-assessment using the rubric provided below and write down your scores.

Criteria 1 –

Criteria 2 –

Criteria 3 –

Criteria 4 –

Example Flipped Classroom Activity

1. Course – Digital Electronic Circuits
Topic – Boolean Expressions

PART 1 – OUT-OF-CLASS SEGMENT

2. Learning Objectives:

After watching the video, students will be able to:

- a) Explain the DeMorgan's theorem using Truth Tables (Understand Level)
- b) Derive basic identities from other identities (Apply Level)
- c) Simplify Logic Circuits, with at most 3 inputs, using identities. (Apply Level)

3. Resource

a) Main Video resource

<https://www.youtube.com/watch?v=33IZkusUW0E&list=PLDFF5A99731ECFC6C&index=6>

Segment	Time Duration
Segment 1 – Basic Identities Part I	0:00 – 13:25
Segment 2 – Basic Identities Part II	13:27 – 19:46
Segment 3 – Proving and Deriving Identities	19:47 – 25:56
Segment 4 – Simplifying Circuits using identities	25:57 – 31: 42

b) Slides shown in the video and Reference Text book chapter are provided as additional reference resources

4. Assessment Questions

1. Simplify the expressions

a. $(A+A').B$

b. $A.((B+C').(A+B+C))$

c. $((A+B)'.B).((A'+B')+(A+B)')$

d. $((A+(A+B)').(B+A)')+B$

2. Using Proof by Perfect Induction, prove DeMorgan's Theorem for 3 inputs.

3. Explain using DeMorgan's theorem, how we can convert AND-OR Logic to NAND only or NOR only Logic?

4. Simplify the given Logic Circuit:

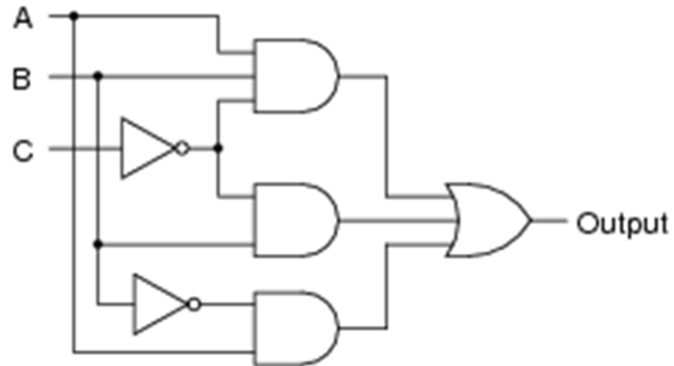

5. Instructions to Students

You will be provided with a video link, slides and an assignment for the class on 15-Jul-2014. You will have to watch the video, perform the activities and submit the assignment by 11:55 AM on 14-Jul-2014. If you do not submit this assignment you will not be given attendance for lecture on 15-Jul-2014. The assignment carries 20 marks out of which 4 marks are provided for timely submission. The assignment carries 5% weightage in your internal assessment. Detailed instructions are provided within the document ReadMeFirst.txt on how to perform the activities and submit the assignment.

Content of ReadMeFirst.txt

1. Watch the video segment 1 (pause the video at 13:25, immediately after order of operations)
2. The corresponding slides are 1-14 within Resource 1 provided, and the textbook chapter is “Chapter 2: Boolean expressions”, in which these are listed under Boolean Identities.
3. Now do questions 1 a) and 1 b) in the assignment
4. Now watch Video Segment 2 (pause video at 19:46). The corresponding slides are 15-18
5. Do questions 1 c) and 1 d)
6. Watch segment 3 and pause video at 25:56
7. Now do the assignment questions 3 and 4
8. Watch segment 4 and pause video at 31:42
9. Now do question 4 and complete the assignment.
10. Submit the assignments in my room by 11:55 AM by 14-Jul-2014. I will not consider them for marking. Submission of assignment is essential for sitting in the class on 15-Jul-2014

PART 2 –IN-CLASS SEGMENT

6. Learning Objectives

At the end of the class, students will be able to

- a) Solve real-life scenario problems involving simplification of Boolean expressions
- b) Implement logical expressions using Universal gates (NAND or NOR)

7. Choice of AL Strategy

Peer Instruction and Think-Pair-Share

8. My Classroom strategy

Before the class starts I would have obtained feedback about their learning based on the out-of-class assignment. And the in-class strategy will depend on how students have attempted this assignment.

- a) If it is a positive feedback, i.e, more than 80% of the class are able to do 80% of assignment, then I will just proceed with two sets of PI questions which will take note more than 5 minutes.

Type III PI question (Predict an outcome).

Q1: What will happen to the output if one of the input to the logical AND gate is 1

- a. Output is always 1
- b. Output is always 0
- c. Output will be same as second input
- d. Output will be complement of second input.

During the discussion after the re-poll I will ask the students why they chose a particular answer. The entire activity will be concluded in 2 minutes. (30 seconds for posing the question and initial poll, 1-minute discussion and another 30 second for re-poll)

Type I PI questions (Conceptual – One right Answer)

Q2: Which of the Boolean expressions correctly represent a 3-input OR $(A+B+C)$?

- a. $(A.B)'. C'$
- b. $A'. B'. C'$
- c. $(A.B.C)'$
- d. $(A'. B'. C')'$

In the initial poll if there are many wrong answers I will ask them to discuss among themselves and then go for a re-poll. The entire activity will take 3 minutes (1 minute posing question and initial poll, 1 minute discussion and 1 minute for re-poll)

b) If it is a negative feedback, i.e. only 20% of the class are able to do 80% of assignment, then I will do 2~3 Type I (Conceptual - One right answer) questions from each of the four types of questions given in the out-of-class assignment. This will take an entire class and hence I will not target higher learning objectives in this scenario.

c) For any other combination I will spend near to 15 minutes on PI activities with more focus on the type of problems that maximum students made mistake in.

TPS for implementing real-life scenarios using NAND and NOR only circuits.

Instructional Goal – Detailing or Making use of Boolean identities to solve problems that involve real-life scenarios.

Original Question:

Four sensor circuits S1, S2, S3 and S4, located at four different directions of an agricultural land, are used to communicate weather information about excess Humidity and temperature to a central station located at a distant agricultural university. The circuits give a high output if the value of temperature and humidity exceeds prescribed limit in a 4 second cycle – i.e. first S1, then S3, then S2 and finally S4. The central station needs to know which area gave high output.

Assuming that each information is passed as digital signals through one digital circuit kept in the farm, develop a boolean expression for implementing the selection of signal using minimum number of universal gates.

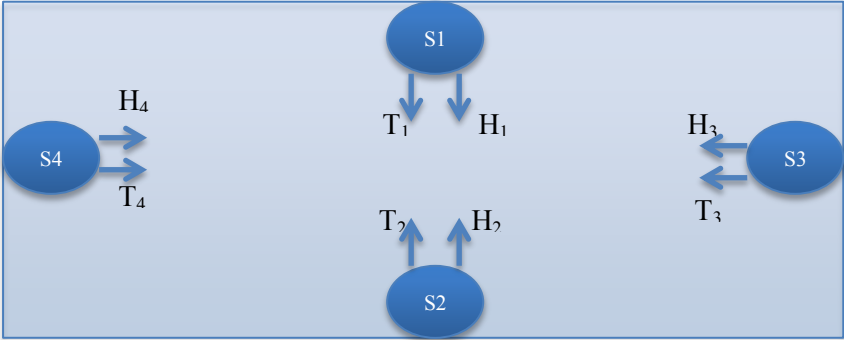

Think (~2 minutes)

Instruction: Assuming that Temperature and Humidity of a station are two Boolean variables T_n and H_n (where n is the station number) as given in the fig, Think individually and identify the scenario (boolean expression) in which a high output will occur from an area.

Pair (~3 minutes)

Instruction: Now pair up and compare your answers. Agree on one final answer.

While students are pairing and discussing, instructor goes to 2~3 sections to see what they are doing.

Now assuming that two variables A and B, as shown in table, are used to select sensor output based on time, develop a Boolean expression to combine time selection and output selection.

i.e. A,B and output (T+H)

A	B	Sensor
0	0	S1
0	1	S2
1	0	S3
1	1	S4

Share (~5 minutes)

Instructor asks a group to share their answer with class and see whether there are different answers. After sharing is done, instructor gives feedback on the correct solution and how minimizations using Boolean expressions play a major role in real life applications, like Multiplexer.

In the next iteration of TPS, in the Think Phase we ask students to convert the Boolean expression in the form of NAND only logic using DeMorgan's Theorem and identities.

In the pair phase we ask students to compare the answers

In the share phase again the different answers are sought.

9. Assessment strategy

The PI and TPS Questions will act as first set of assessment. In the final 10 minutes of the class, I will ask them other assessment questions:

- How many 3-Input NAND gates are required for realizing a 3-Input OR gate?
- Simplify $(A+(A.C'+B.(A'+C')))+(A'.(B+B.C+B'.C'))$
- What will be the logical expression for realizing a 2-Way switch, assuming A and B are two switches?

10. Self-evaluation

Criteria 1 – Exemplary (3)

- Criteria 2 – Adequate (2)
- Criteria 3 – Exemplary (3)
- Criteria 4 – Adequate (2)

RUBRIC FOR ASSESSING OUT-OF-CLASS ACTIVITY

Criteria for judging the created assignment and the corresponding scores are given below. We have used the example of Digital Logic circuits in explaining this marking scheme so that you will be able to connect to what you mention in

Criteria/Scale	Missing (0)	Inadequate (1)	Adequate (2)	Exemplary (3)
1. Learning Objectives for Out-of-class activity	Learning Objectives are missing.	<p>Learning Objectives have been stated, however they are not properly constructed or are addressing higher order thinking skills.</p> <p>For e.g. Students will be able to understand DeMorgan's theorem Or Students will be able to design circuits using NAND and NOR gates.</p>	<p>Learning Objectives have been stated using specific and measurable action verbs at Lower Cognitive levels.</p> <p>For e.g. Students will be able to <u>explain</u> DeMorgan's Theorem</p>	<p>Learning objectives have been stated using specific and measurable action verbs with needed qualifiers to increase the clarity.</p> <p>For e.g. Students will be able to <u>explain</u> DeMorgan's Theorem <u>using Truthtables</u>.</p>
2. Length of the Video	No video link is present.	<p>The video is shorter than 3 minutes or longer than 20 minutes.</p> <p>For e.g. providing links to an hour-long NPTEL lecture on Digital Logic Circuits.</p>	<p>The video length is between 5~15 minutes. If the total video is more than this time duration, then it has been split-up into multiple parts to satisfy the 5~15 minutes criterion.</p>	<p>The video length is around 10 minutes. If the original video was having more length then it has been split into separate parts to satisfy 10minute criterion using editing</p>

			For e.g see Appendix 1. There are four segments, each of which is less than 15 minutes	softwares like MovieMaker. For e.g. the same four segments in Appendix 1 are created as four separate videos using MovieMaker.
3. Instructions to students for doing out of class activity	No instructions are present	The instructions just merely suggest them to watch video and perform the activity. For e.g. the instruction will be to watch the lecture and answer assessment questions	The instructions go beyond mere suggestions, and specifically provide instructions like when to pause the video or when to attempt an activity. For e.g. the instruction says Pause the video at 23:56 and attempt assessment question 3 and 4	The instructions go beyond suggestions on how to perform the activity and specify the incentives for doing the out-of-class activity For e.g. as seen in appendix 1, Instructor specifies 4 marks for submitting assignment on time and linking assessment submission to attendance.
4. Out-of-class Assessment	No assessment questions have been mentioned.	Assessment questions have been mentioned, however they are not matching the level of the learning objective set. For e.g. for Understand level learning objectives listed above in Row 1, the assessment question is Design circuits using NAND or NOR?	The Assessment questions mentioned are appropriate to the levels of learning objective. For e.g. for the understand level learning objective, the assessment question is Prove DeMorgan's Theorem.	The Assessment questions have clarity in assessing the learning objectives set and are linked to the video. For e.g. the assessment for Learning Objective discussed in row 1 is: Based on the description provided in the video, prove DeMorgan's theorem using Proof by Perfect Induction

APPENDIX C – Samples of wiki activity during Iteration 2

Landing page for wiki users in the training ET4ET₁ (Iteration 2)

☆ QEEE Repoistory

Edit 0 33 ...

view 33 revisions

About QEEE Course

This repository contains the resources created by participants within the QEEE Pedagogy workshop conducted from June 14 - Aug 2, 2014. The course was a blended course, in the sense that there were both synchronous and asynchronous sessions, spread over 8 weeks and conducted in 4 phases. The first and third phases were Synchronous Remote sessions conducted through A-View and the other two sessions were asynchronous conducted through Moodle. There were a total of 1193 participants spread over 38 Remote Centres (Colleges).

Grading the wiki

The Wiki Grading Rubric for the QEEE Repository will have the following major elements:

- Content - Quantity and Quality of Resources
- Appearance - Organization of wiki pages and ease of navigation
- Collaboration - How are participants, within and across remote-centres, to achieve the overall purpose of the Wiki (i.e. creation of content repository for Peer Instruction and Think-Pair-Share activities)

The actual rubric is available in the [Grading page](#).

IMPORTANT - REGARDING FILE UPLOADS

As this is a normal wiki, there is a limit to file upload size. So do not upload any files to this wiki, unless specifically asked

Project Pages

The QEEE Repository project is an activity aimed at creating a content repository of PI and TPS questions. The table contains the details of the institutions who participated in this workshop and the number of registered participants from each institution. By clicking on the institution you can view more details about the institution and their participants. The project space of each institution can be seen by clicking on the Project button on the right hand column next to this page (Below Wiki Home). Select the institution from the list under the QEEE Repository project in it.

Sl. No	Institution Name	Organizer	No: of registered participants
1.	IDP-ET, IIT Bombay	Rset_iitb	11
2.	GCT, Coimbatore	ilamathi	10
3.	UIET, Chandigarh	Quiet_sakshi	
4.	MIT, Manipal University	Qmit_shaillesh.kr	14
5.	BSAbdur Rahman University	Venkat_se	15
6.	Heritage Institute of Technology	Heritage_sudipta	29
7.	BMS College of Engineering		
8.	GEC Modasa	hnraval	08

ory/QEEE+Repoistory

A typical landing page for each remote centre

☆ home Edit 0

Welcome to the GCTCoimbatore home page.

To get started, just click Edit and start typing. If you have any questions about working in a Wikispaces project, check out our Project help page. We are the participants of Pedagogy Workshop organized by IIT Bombay from Government College of Technology, Coimbatore.

This page is the space where we have created our own PI and TPS activities on various domain.

Instructions on how to populate the page

1. Indicate the domain in which you would be contributing the PI and TPS resource under the section Domains by replacing the "Enter Domain" text with name of the domain
2. Each domain will be a separate page where you will list the topic and then the PI and TPS resource. For creation of new page you only have to select the text and click on the link present at the top of the edit area.
3. You are free to create separate pages for your PI and TPS activities or include them under the domain page itself.
4. Use the PI Activity Constructor and TPS activity constructor (available under [Resources page](#)) for creating PI and TPS activities.
5. Participant do not need to create any project page. This is the Home Page of the Project. They only have to create domain page which they will populate with some PI and TPS activities on several topics of that domain.

[Project help page.](#)

Courses

The various domains for which resources have been created are :

- [Production Engineering](#)
- [Mechanical Engineering](#)
- [Finite Element Analysis](#)
- [Design of Machine Element](#)
- [Design of Shaft](#)
- [Electronics and Instrumentation Engineering](#)

Example pages created by participants from mechanical engineering for the assignment to design Peer Instruction activity in their own topic.

☆ Manufacturing Process

✎ Edit 1 2 ...

Manufacturing process is nothing but making the component based on customer requirement
There are two types of manufacturing process
1) Primary manufacturing Process (Casting, Powder Metallurgy)
2) Secondary manufacturing process (Machining i.e. Lathe, Drilling, Milling etc)

Peer instruction for this
A. Goal: Conceptual reasoning "one right answer" questions.

The process of making circular holes on a solid piece
a) Drilling
b) Knurling
c) Facing

B. Goal: Discussion "no one right answer" questions

Process of making conical surfaces on work piece
a) Thread cutting
b) Plain turning
c) Step turning
d) None of the above

C. Goal: Predict an outcome (e.g., of an experiment, or a program)

Can a milling machine be used for a drilling purpose
a) Drilling is performed smoothly
b) Drilling cannot be performed
c) Drilling is partially performed

Think Pair share

Write your Think phase question here:
How can a drilling operation be performed on a lathe machine? Justify.

Write your Pair phase question here:
How are drilling operations performed on a lathe machine? Justify your answer by pairing with your neighbor.

 Add Discussion

 **PI Qs**
ilamathi Aug 5, 2014

This page does not contain all the types of PI questions

 Comment

Subject: Dynamics of Machines

Topic: Balancing of rotating and reciprocating masses

Peer Instruction

A. Goal: Conceptual reasoning "one right answer" questions.

Q 1. Rotating Wheel, if it is not completely round and if it does not rotate evenly about its central axis, what would happen to wheel.

1. The wheel would vibrate causing damage to itself.
2. The wheel would rotate smoothly because of centrifugal forces.
3. The wheel would rotate smoothly because of uneven mass distribution.

Q 2. The unbalanced vertical force due to balancing of the reciprocating parts in a locomotive varies

1. directly with the speed
2. directly with the square of the speed
3. inversely with the speed
4. inversely with the square of the speed

B. Goal: Discussion "no one right answer" questions

Q.1 If a weight equal to the weights of reciprocating parts is attached diametrically opposite to the crank at crank radius, then

1. primary disturbing force is completely balanced
2. engine is completely balanced
3. an unbalanced vertical force is introduced

C. Goal: Predict an outcome

1. A rotor supported at A and B, carries two masses as shown in the given figure. Where mass m_a is half of m_b and radius R_a is double of R_b . The rotor is

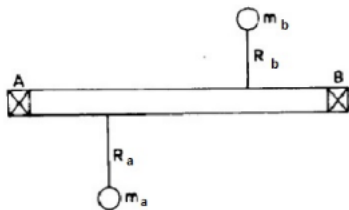

- (A) dynamically balanced
- (B) statically balanced
- (C) statically and dynamically balanced
- (D) not balanced.

D. Goal: Embed reasoning in answers

1. In locomotive, with two cylinders, the cranks of two cylinders are placed at right angle to each other **in order to**

- (A) start the locomotive in any position
- (B) reduce the effect of secondary forces
- (C) reduce the effect of primary forces
- (D) all of the above

1. In a locomotive

- (A) The unbalanced vertical force due to balancing of the reciprocating parts causes tractive forces
- (B) The unbalanced vertical force due to balancing of the reciprocating parts causes Swaying Couple
- (C) The unbalanced vertical force due to balancing of the reciprocating parts causes hammer blow
- (D) all of the above

E. Goal: Reason using representations

Q.1 Which rotor arrangement is statically balanced:

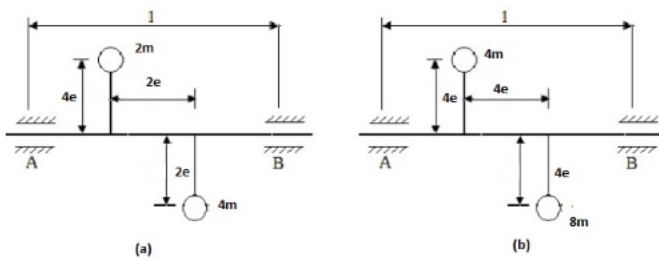

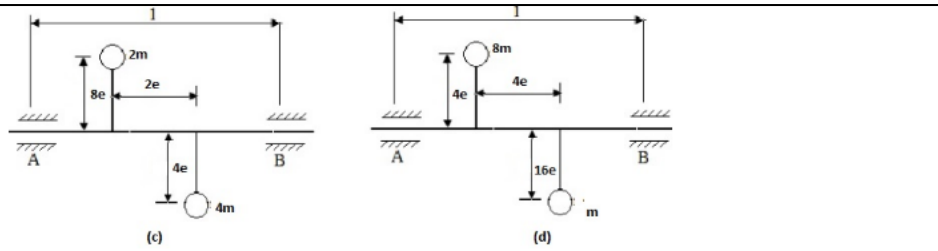

F. Goal: As a stepping stone to problem-solving

Q. Two Cylinder uncoupled locomotive has 280 kg rotating mass per cylinder, 300kg reciprocating mass per cylinder, distance between wheels is 1400mm, distance between cylinder centers is 600mm, crank radius is 300mm, diameter of driving wheels is 1800mm, balance mass center radius is 620mm, locomotive speed is 50km/hr, Angle between cylinder cranks is 90° and dead load on each wheel is 3.5 tonne. If whole of the revolving and two third of reciprocating mass are to be balanced,

1. which equation you would follow to determine the required balancing mass in the planes of driving wheel
 - (a) force equation
 - (b) couple equation
 - (c) both force and couple equation
1. Minimum number of balancing masses are required
 - (a) One
 - (b) Two
 - (c) Four
1. What would be the magnitude and direction of balancing mass/masses
 - (a) 178.7kg, 2480
 - (b) 178.7kg, 2480 and 178.7 kg, 201.80
 - (c) 178.7kg, 2480, 173.7 kg, 21.80 and 150kg, 2450
1. What would be the effect of partial balancing in locomotives
 - (a) Hammer blow
 - (b) Variation of tractive force
 - (c) Swaying couple
1. In this problem, Swaying couple is
 - (a) 3030.3 Nm
 - (b) 1000 Nm
 - (c) 0
1. The variation in the tractive force
 - (a) 10100 N
 - (b) 20100 N
 - (c) 0

1. The variation in the tractive force

- (a) 10100 N
- (b) 20100 N
- (c) 0

1. The effect of hammer blow is

- (a) Produce constant pressure on rails
- (b) Produce variable pressure on rails
- (c) Produce zero pressure on rails

1. Value of pressure on rails

- (a) Max. 45326 N and min 23344 N
- (b) 23344 N constant
- (c) 0 N

1. Maximum speed of locomotive without lifting the wheels from the rails would be when

- (a) Dead load equal to hammer blow
- (b) Dead load greater than hammer blow
- (c) Dead load lesser than hammer blow

1. Maximum Speed is

- (a) 88.36 km/hr
- (b) 100.56 km/hr
- (c) 115km/hr

G. Goal: Recall point from previous lecture

1. For complete dynamic balance, at least mass/masses are necessary.

- (A) two
- (B) three
- (C) four
- (D) one

1. Dynamic balancing involves balancing of

- (A) forces
- (B) couples
- (C) force as well as couples
- (D) masses

Example pages created by participants from mechanical engineering for the assignment to design Think Pair Share activity in their own topic

(D) masses

1. The frequency of the secondary force as compared to primary force is

(A) one-half

(B) double

(C) one-third

(D) one-fourth

H. Goal: Survey questions / personal opinion

1. How to balance Single and multiple plane unbalance forces?

(a) Using Static force equilibrium equation only

(b) Using Couple equation only

(c) Both (a) and (b) is required

2. How to balance primary and secondary forces in locomotive engines?

Think-Pair-Share Activity

Q. How we can balance the system of rotating masses If

- Combined mass centre of the system lies on the axis of rotation (Several rotating masses rotates in the same plane)
- Several rotating masses rotate in the different planes.

Write down the methodology.

Discuss your answer with your neighbor, Discuss different types of solution (analytical and graphical) of this problem Do pros and cons analysis of your solution.

Share

Q. Recall different types of method for balancing of reciprocating masses that we discussed in the class, solve this following problem:

An In-line two cylinder engine. Consider a two cylinder engine, cranks of which are 180° apart and has equal reciprocating masses (m). Taking reference plane as a plane through the centre line.

Student, you and your neighbor have to now solve this problem. One of you has to find the primary unbalance force and couple, while other secondary unbalanced force and couple. (-5 min)

Along with their neighbor, each student write, what is the total unbalanced force and couple exist in the in-line two cylinder engine. Also find the location.

Now if we introduce one counter mass with crank (2 times of the reciprocating mass m) at the centerline, 90° apart. What would be the effect on unbalanced primary and secondary forces and couples? (-10 min)

Example pages created by participants from computer science and allied engineering domain for the assignment to design Peer Instruction activity in their own topic

☆ Information Technology

Edit 0 6 ...

PI Instruction
Subject: Computer Organization
Topic: ALU
Contributor : Rituparna Sinha(Samaddar),Heritage Institute Of Technology

A. Goal: Conceptual reasoning "one right answer" questions

Using a ripple carry adder and recollecting that a xor gate can be used to complement an input, apply number A directly as an input to ripple carry adder and apply number B through the xor gate into the other input of the adder. If you apply a 1 to carry in port of the least significant bit handling Full Adder of the ripple carry adder, the output will give

1. Sum of A and B
2. Sum of A and B'
3. Sum of A,B and 1
4. Difference of A and B in 2's complement

Peer Review Table

Peer1 Sudipta Bhadra : Peer2 username: [Laxmi Hegde](#)

Peer3 username: Peer4 username:

Peer review activity done inside the wiki for evaluating Peer Instruction activity.

Peer Review Table

Peer1 Sudipta Bhadra : Peer2 username: [Laxmi Hegde](#)

Peer3 username: Peer4 username:

Pedagogical Goal of Question	Peer 1 Eval Score	Peer 2 Eval Score	Peer 3 Eval Score	Peer 4 Eval Score	Average Peer Eval Score
<i>This PI question tests if students have understood the core concept at an appropriate level</i> 1 – question does not match intended objective 2 - question matches intended objective to some extent 3 - question matches intended objective well	3	3			
The PI question is likely to stimulate discussions between students. 1 - unlikely 2 - to some extent 3 - definitely	2	3			
The choices in this question are plausible student responses and are likely to elicit their misconceptions 1 - Only one obvious correct answer 2 - Two plausible answers 3 - Multiple plausible choices	1	1			
The challenge level of this PI question is 1 - easy 2 - just-right 3 – difficult	2	2			
This PI question matches its stated pedagogical goal (on the column heading) 1 - Does not match 2 - Partial matches 3 - Matches well	3	3			

B. Goal: Discussion “no one right answer” questions

What can be the building blocks – basic electronic combinational circuits that can be used to implementing Arithmetic Unit and data path?

1 Full adders

2 Full adders and shift registers

3 Multiplexers

4 Multiplexers and full adders

Peer Review Table

Peer1username: Sudipta Bhadra Peer2 username:[Laxmi Hegde](#)

Peer3 username: Peer4 username:

Pedagogical Goal of Question	Peer 1 Eval Score	Peer 2 Eval Score	Peer 3 Eval Score	Peer 4 Eval Score	Average Peer Eval Score
<p><i>This PI question tests if students have understood the core concept at an appropriate level</i></p> <p><i>1 – question does not match intended objective</i></p> <p><i>2 - question matches intended objective to some extent</i></p> <p><i>3 - question matches intended objective well</i></p>	2	3			
<p>The PI question is likely to stimulate discussions between students.</p> <p><i>1 - unlikely</i></p> <p><i>2 - to some extent</i></p> <p><i>3 - definitely</i></p>	2	3			
<p>The choices in this question are plausible student responses and are likely to elicit their misconceptions</p> <p><i>1 - Only one obvious correct answer</i></p> <p><i>2 - Two plausible answers</i></p> <p><i>3 - Multiple plausible choices</i></p>	2	3			
<p>The challenge level of this PI question is</p> <p><i>1 - easy</i></p> <p><i>2 - just-right</i></p> <p><i>3 – difficult</i></p>	2	2			
<p>This PI question matches its stated pedagogical goal (on the column heading)</p> <p><i>1 - Does not match</i></p> <p><i>2 - Partial matches</i></p>	2	3			

Discussion and peer review of Think-Pair-Share activity designed by participant

Pair Phase:

If there is any disagreement among neighbors ask them to discuss their ideas.

Again ask all to commit to an option.
Guide a discussion of the class over all types of registers visible in the animation.

What value will be loaded into register BL ?

- 1) 10
- 2) 6
- 3) 7
- 4) 12

Get students to commit to one option.
If any disagreement exists ask neighbor to discuss their ideas to come to an agreement.
Guide discussion on address of memory location.

What will be the value stored in location 8 at the end of the program ?

- 1) 6
- 2) 7
- 3) 22
- 4) 10

Get students to commit to one option.
Ask neighbors to discuss any difference of opinion.
Show the remaining steps.
At each step ask different group members to explain which part of the instruction cycle is happening and what all sequence of micro-operations are shown in the step.

At end give a summary of the various phases of the instruction cycle.

 Add Discussion

 **CSE DBMS**
alkajindal Aug 19, 2014

regarding TPS activity on DBMS Normalization by Sumana Barman,Heritage Institute Of Technology. I found that this Conceptual Understanding question can be given after the explanation of the concept and will be able to help students to think in terms of FD's.

 Comment

☆ Data Structure

THINK PAIR SHARE ACTIVITY FOR LINKED LIST

Course: Data Structure

Topic: Linked List

Broad Topic:- Inserting nodes in Linked List

Think phase: Initial Seed Question is :-

After introducing students to the concept of linked list:- Students shall write steps to insert a node between two arbitrary nodes.

Time allowed: 5-7 minutes

Pair phase: Students shall pair up with his/her peers :-

Answer following:-

1. Find out whether there are certain special cases? If yes work out a mechanism to reach nodes between which new node is to be inserted?
2. While inserting a new node, from where memory allocation will be done and who will be responsible for managing this memory allocation?
3. If user is going to manage this allocation, what will be the mechanism and how various pointers will be manipulated?

Time allowed: 15-20 minutes

Share phase: See this diagram and correct your answer:-

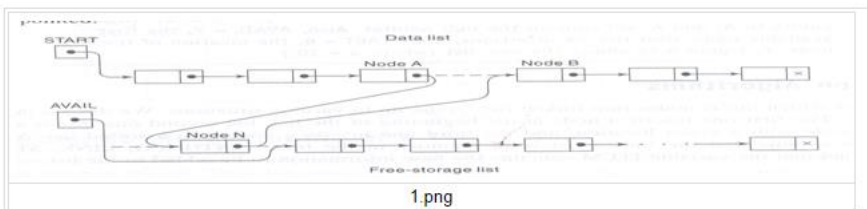

1.png

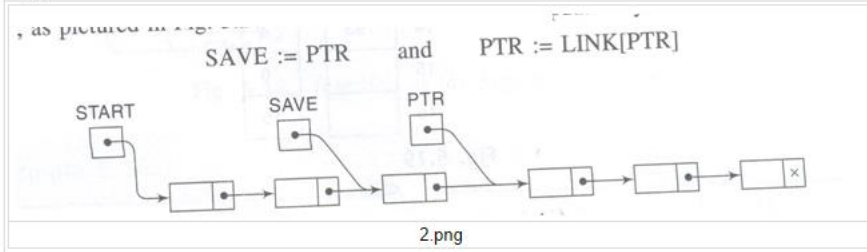

2.png

Time allowed: 5-10 minutes

 Add Discussion



TPS activity

[Padmavati](#) Aug 17, 2014

We can give many TPS activity questionnaires to students based on linked list such as sort the given linked list, search an element in a linked list, delete a node from the list, merge two lists etc.



Comment

APPENDIX D – Samples of Wiki activity during Iteration 3

Landing page for wiki users in the training ET4ET₂ (Iteration 3)

T10KT Repository

This repository contains the resources created by teachers within the T10KT Pedagogy workshop going to be conducted from Jan 5 - Jan 31, 2015. The course is a blended course, in the sense that there are both synchronous and asynchronous sessions, spread over 4 weeks and conducted in 4 phases. The first and third phases are Synchronous Remote sessions conducted through A-View and the other two sessions are asynchronous conducted through Moodle. There were a total of .

IMPORTANT - REGARDING FILE UPLOADS
As this is a normal wiki, there is a limit to file upload size. **So do not upload any files to this wiki, unless specifically asked**

HELPFUL PAGES AND RESOURCES FOR BASIC WIKI EDITING
Here are a list of helpful pages and videos which will help you complete the initial set of tasks that were given.
a. Basic Wiki Editing - [Wikispaces Help Page](#)
b. We have created a set of short videos for doing various tasks in one of our team member's [home page](#). You need to have flash plugins enabled to watch the videos in browser. Alternately you can watch related videos in youtube by regular search.

Project Pages
The [T10KT Repository project](#) is an activity aimed at creating a content repository of workshop activity. The table contains the details of the institutions who participated in this workshop and the number of registered participants from each institution. By clicking on the institution you can view more details about the institution and their participants. The project space of each institution can be seen by clicking on the Project button on the right hand column next to this page (Below Wiki Home). Select the institution from the list under the QEEE Repository project in it.

Sl. No	Institution	Coordinator	Number of Participants
1	IDP-ET, IIT Bombay	Rset_iitb	18
2	Don Bosco College of Engineering & Technolog. Guwahati, Assam	Bikash Agarwal	11
3	U V Patel College of Engineering, Gujarat	Kirit J Modi	27
4	Regional Centre of Anna University, Tirunelveli	K.Saravanan	19
5	Muffakham Jah College of Engineering and Technology, Hyderabad	Mohammed Arifuddin Sohel	
6	Walchand Institute of Technology, Solapur, Maharashtra	Manisha Nirgude	48
7	Vels University, Pallavaram, Chennai	C. Dhanasekaran	40
8	Dronacharya College of Engineering, Greater Noida, Uttar Pradesh	Ashwani Kumar	29
9	Shri Shankaracharya Institute of Professional Management & Technology, Raipur, C. G	Mr. J P PATRA	20
10	AGNI COLLEGE OF TECHNOLOGY, Chennai	Dr.P.S.K.Patra	31
11	Dr.J.J. Magdum College of Engineering, Jaysingpur.	Prof.Mrs.Deepali Nikam	60
12	Kongu Engineering College, Perundurai, Erode, Tamilnadu	D.Sivabalaselvamani	43
13	Selvam College Of Technology, Namakkal, Tamilnadu	N.Prasannan	50
14	EBET Group of Institutions , Tirupur , Tamilnadu	S.R.Karthikeyan	21
15	Vignan Institute of Technology & Science, Deshmukhi, Nalgonda Dist, Telangana State	N Dinesh Kumar	7
16	Vidyaa Vikas College of Engineering and Technology, Tiruchengode, Namakkal, Tamilnadu	M.Jayaprakash	44
17	C-DAC Noida	Vijay Kumar Sharma	32
18	Techno India	Soumitra Sasmal	24
19	Regency Institute of Technology, Yanam	M.N.M.Prasad	23
20	Nirma University, Institute of Technology, Ahmedabad	Vipul Chudasama	10
21	Jawaharlal Institute of Technology Borawan	Sanjay Chouhan	01
22	Sharad Institute of Technology, College of Engineering, Yadav.	Umar Mulani	18

23	Sitarambhai Naranji Patel Institute of Technology And Research Centre, UmraKh, Surat,Gujarat.	Himani Bhatt	30
24	Medi-Caps Institute of Technology and Management, Indore	Vaishali Chourey	
25	GITAM University, Hyderabad Campus, Medak District, Telangana	S. Phani Kumar	60
26	SIES Graduate School Of Technology,Nerul,Navi Mumbai .MS	Aparna Bannore	28
27.	Dr.Mahalingam College of Engineering and Technology.Pollachi,TamilNadu	K.Thirukumar	20
28	Sagar Institute of Research & Technology - Excellence, Bhopal	Megha Kamble	30
29.	LDRP INSTITUTE OF TECHNOLOGY AND RESEARCH, Gandhinagar Gujarat	Dushyant Patel	
30.	School of Management Sciences Technical Campus Lucknow	Rajiv Kumar	22
31	Sasurie College of Engineering . Tirupur	Sathishkumar J	39
32	Techno India NJR Institute of Technology, Udaipur	Piyush Javeria	38
33	Dronacharya College of Engineering, Gurgaon, Haryana	Dr. Jitender Kumar	40
34	Mukesh Patel School of Technology Management & Engineering, Mumbai	Swarnalata Bollavarapu	12
35	Raj Kumar Goel Institute of Technology for Women,Ghaziabad	Dr.Nitin Pratap Singh	33
36	Jaipur Engineering College	Dr Sunita Rawat	40
37	Rajarambapu Institute of Technology, Islampur, Sangli	Mrs. Savita Prashant Patil	24
38	O.P. Jindal Institute of Technology, Raigarh	Mr.Pradeep S Chauhan	21
39	Bhagwan Parshuram Institute of Technology	Dr. Deepali Virmani	60
40	SSM College of Engineering, Komarapalayam, TamilNadu	A.T.Ravi	60
41	Sir Padampat Singhania University (SPSU)	Mr. Subhrendu Guha Neogi	10
42	S.D.M. Institute of Technology Ujire, Karnataka	Mr. Manjunatha	
43	Sri Eshwar College of Engineering,Coimbatore	Mr.P.John Augustine	14
44	Mepco Schlenk Engineering College, Sivakasi	T.Revathi	33
45	Jawaharlal Nehru National college of Engineering, Shimoga, Karnataka.	Dr.Ushadevi M.B	30
46	SASTRA University, Thanjavur-613401, Tamil Nadu	Dr. N. Sairam	42
47	Technology Education and Research Integrated Intitutions, Kurukshetra, Haryana	Mr. Kapil Saini	14

43	Sri Eshwar College of Engineering,Coimbatore	Mr.P.John Augustine	14
44	Mepco Schlenk Engineering College, Sivakasi	T.Revathi	33
45	Jawaharlal Nehru National college of Engineering, Shimoga, Karnataka.	Dr.Ushadevi M.B	30
46	SASTRA University, Thanjavur-613401, Tamil Nadu	Dr. N. Sairam	42
47	Technology Education and Research Integrated Intitutions, Kurukshetra, Haryana	Mr. Kapil Saini	14
48	Oriental College of Technology, Bhopal	Mr. Jitendra S. Rathore	48
49	SAINTGITS College of Engineering	Dr. M. C. Philipose	22
50	Shri Vaishnav Institute of Technology and Science,Indore (MP)	Prof.Namit Gupta	37
51	IPS ACADEMY ,INDORE (MP)	NAZIYA HUSSAIN	23
52	Shri Sant Gajanan Maharaj College of Engineering,Shegaon(MS)	Ms.Priti V. Kale	22
53	Madhuben And Bhanubhai Patel Women's Institute of Engineering, Anand, Gujarat	Mr.Nikunj Shingala	18
54	Tatyasaheb Kore Institute of Engineering & Technology, Warananagar	Mr. Nandkishor B Jadhav	32
55	Electronic Science Department Kurukshetra University Kurukshetra	Mr. Sumit Choudhary	17
56	St Francis Institute of Technology (Engineering College), Borivali, Mumbai	Dr. Uday Pandit Khot	19
57	Symbiosis Institute of Computer Studies and Research, Pune	Harshad Gune	15

[SAINTGITS College of Engineering](#)

[Electronic Science Department Kurukshetra University](#)

 Add Discussion

 How participants will enroll in the WIKI
[Ped_1290rcc](#) Dec 24, 2014

Sir,
Please suggest how the participants of our organization will enroll inside wiki and collaborate to each other through wiki.

 [Rset_iitb](#) Dec 30, 2014
We will be giving instructions on participant registration this week.

 [Ped_1235rcc](#) Jan 2, 2015
Is there any wiki activity for the registered participants. Only they are given moodle login.

 [Rset_iitb](#) Jan 2, 2015
At this moment there are no activity for participants, but during the course of workshop participants will be given specific tasks.

 [Ped_1060rcc](#) Jan 2, 2015
How to Remove Duplicate Page RC 1060 ? i have checked in More Options in the Page.

 [Rset_iitb](#) Jan 2, 2015
In more options, choose the delete button..

Landing page for remote centres where the remote centre coordinator is supposed to provide details of the centre.

☆ 1235-Dr.Mahalingam College of Technology

Edit 0 10 ...

About RCC
Dr. Mahalingam College of Engineering and Technology (MCET)

is an autonomous, self financing, co-educational institution in Pollachi. MCET is part of Sakthi Group of Companies with a strong commitment to technical education in South India with their impeccable credentials of an educational lineage dating back to sixty years with an enlightened management under the visionary guidance of Arutchelvar Dr. N. Mahalingam as Chairman Emeritus and Dr. M. Manickam as Chairman.

RC Strength
Dr.MCET has 9 UG Programmes such as CSE , CIVIL, EEE , EIE , IT , ECE , MECH , Automobile , ICE and PG Programmes in Computer Science, Mechanical, ECE, EEE, Civil and Computer Applications.The campus has all necessary facilities & well established laboratories as per the norms of AICTE & UGC. Also it offers Research Programme (Ph.D) in Mechanical and EEE departments.

The campus imparts not only the state-of-the-art technical knowledge, but also integrates value education, Centre of Excellence,Industry collaboration, communication skills into its curriculum to mould the students as responsible citizens.

Our main strength lies in world class infrastructural facilities, dedicated and experienced faculty having Industrial, Research and Teaching experience at National and International level. The rich experience of our faculty provides quality teaching and research guidance to our students.

Unique Facilities in the Campus

1800+ computers * Single mode fiber optic cable connecting all 1800+ computers * **100 Mbps internet connectivity** * Computerized Library Functioning all 365 days * Modernized Boys & Girls Hostel with Internet Facilities * Multipurpose Indoor Sports Auditorium with 4000 seating capacity * World class Internet Data Center * Presence of various clubs viz Rotarct, Consumer, ECO, Renewable Energy, Fine Arts, Tamil Mandram etc., * Video Conferencing facilities. * Tele education facilities through Edusat * Yoga & Meditation Hall * Language Learning Centre * Driving School.

MoUs with International Universities

* Edith Cowan University, Australia * University of Cape Breton, Canada * University of Manitoba, Canada * Cambrain college of Applied Arts and Technology, Canada * Northumbria University, UK

MoUs with Corporate World

* Infosys-Campus Connect Programme * Caritor - Adept * Hexaware - Foundation Training Programme * Oracle - Workforce Development Programme.

[Official websit](#)

Nirma University Institute of Technology, Ahmedabad, Gujarat

Institute of Technology, Nirma University, earlier known as Nirma Institute of Technology, started in 1995 by Nirma Education and Research Foundation (NERF), was the first self-financed engineering college in Gujarat. Within 18 years of inception, Institute of Technology is a leading hub of education, offering multidisciplinary undergraduate, postgraduate and Ph.D. programmes in engineering.

The institute is ranked within top 25 self-financed engineering colleges of India in the survey conducted by various rating agencies. The faculty members and students of the Institute have won many prestigious awards and bring laurels to the institute.

The Institute is located in peaceful and sylvan surroundings of Ahmedabad city in the heart of Gujarat. The Institute provides disciplined, serene and conducive environ for reflection, repose and research. The Campus is overwhelmed with lush green sceneries masking the concrete beneath.

The Institute is embarking on an ambitious plan focused on "Growth in Excellence" and creating the "Societal Engineer". The Institute is now aiming to emphasize on Outcome Based Education (OBE), Experiential Education (through Project Based Learning), research in thrust areas with translational impact, and the creation of engineers as leaders in society.

The Institute gives ample opportunities to its students and strives to equip our students in terms of providing the skills, ability and knowledge for life-long learning and accolades. Some of the major strengths of the Institute include:

- Excellent local and regional reputation with well-established national recognition
- Young, dynamic and dedicated faculty and staff members aligned with institutional goals
- Learner centric approach along with personalized attention to the students
- Focus on synergy between teaching and all-round development of the students
- Meritorious students with geographical diversity in undergraduate programmes
- Well placed closed-loop feedback system for curriculum development encompassing all the stake holders
- Globally compatible academic credit system with emphasis on continuous evaluation
- Transparent management policies with well-defined procedures
- Well-disciplined conducive academic environment and ambience
- ICT usage for enhancing various academic accomplishments
- Active linkages with nearby industries and research organizations
- Continuous emphasis on faculty and staff development
- Strong commitment and dedicated efforts towards continuing education and pedagogy

[source: <http://www.nirmauni.ac.in/ITNU/About>]

RC Strength

Faculty strength:179

B. Tech.

Programme	Intake
Chemical Engineering	60
Civil Engineering	120
Computer Engineering	120
Information Technology	60
Electrical Engineering	120
Mechanical Engineering	120
Electronics and Communication Engineering	120
Instrumentation and Control Engineering	60

M. Tech.

Programme	Intake
Chemical Engineering - Environmental Process Design- EPD	18
Chemical Engineering - Energy System	6
Civil Engineering - Computer Aided Structural Analysis and Design-CASAD	30
Computer Engineering - Information and Network Security	30
Computer Engineering - Computer Science and Engineering	30
Computer Engineering - Networking Technologies	30
Electrical Engineering - Power Electronics, Machines & Drives	30
Electrical Engineering - Electrical Power Systems	30
Electrical Engineering - Energy System	6
Mechanical Engineering - CAD/CAM	30
Mechanical Engineering - Computer Integrated Manufacturing	18
Mechanical Engineering - Design Engineering	18
Mechanical Engineering - Thermal Engineering	30
Mechanical Engineering - Energy System	10
Electronics and Communication Engineering - Communication Engineering	30
Electronics and Communication Engineering - VLSI Design	30
Electronics and Communication Engineering - Embedded Systems	30
Instrumentation and Control Engineering - Control and Automation	30

Identification of best resource created within the remote centre

Best TPS						
Sr.no	Domain	Course	Topic	T-phase	P-phase	S-phase
1	Electronics	Industrial Electronics	Controlled Rectifiers	What is the difference between the two converters? Give two points of distinction based on i) conduction period of SCRs ii) effect on average load voltage	If the converters are to be operated for controlled rectification only, is there a limitation on firing angle for the two configurations?	If the converters are to be operated for controlled rectification only, is there a limitation on firing angle for the two configurations?
2.	Mechanical(Printing and Packaging Tech.)	Paper based Packaging Materials	Paper manufacturing	What are the effects of Grain Direction on the properties of Paper? Note down the points in your notebook.	How does Grain Direction affect the physical/mechanical properties of the paper? Together, think of 4 applications in printing and packaging industry where physical/mechanical properties of paper play an important role.	Share with the class, the implication of Grain Direction affecting the physical/mechanical properties of paper in Printing & Packaging Industry with an example.
3.	Computer	Analysis of Algorithm	Searching	Write a pseudo-code and program to search given input integer in array using Binary search method.	Discuss the logic to write pseudocode among your group member to search the given number using binary search. Identify the correct solution. Write a program to implement the solution.	Compare the correct answer with listed on board.

An example of best TPS activity created within the domain in a remote centre

☆ RC_1286Civil ✎ Edit 0 👁 1 ...

Civil Engineering

S.No	Course	Topic	T-Phase	P-Phase	S-Phase
1	Urban mass transport system	Transit mode classification	Write the different transit modes that can be adopted for urban transportation	Among the modes you have written choose the best transit mode/s that can be used to Bangalore city	Compare your choice with other pair and defend your choice stating the positive and negative points of each mode
2	Transportation Engineering	Geometric design of Highways	If you are driving at 40 kmph and see a cat on the road 50 m ahead, Will you stop in time to avoid hitting the cat ?	Discuss and identify the factors that affect the stopping of the vehicle without hitting the cat/object when you are travelling at a particular speed.	Identification and list the factors that depend on stopping sight distance. Defining stopping sight distance. Derivation of the formula with reaction distance and braking distance.
3	Civil Engineering	Draw an architectural plan of a residential building for a given floor area.	Consider a given floor area of 650 sqft for residential purpose. Draw an architectural pan for this given area consisting of two bedrooms, one toilet, one kitchen and one dining. Show the North direction and centre line distances on the diagram.	Compare your diagram with the neighbors' diagram. Discuss how effectively the given floor area is utilized.	Each pair of student should show his/her diagram to the class using projector and share the advantages of the proposed architectural plan. Other students try to judge that how effectively that architectural plan utilizes the given floor area and the possible adjustments required to be carried out to improve the utilization.

🗨 Add Discussion

APPENDIX E – Idea Planning by participants during Iteration 4

IDEA - PROPOSAL

LEARNING OBJECTIVES

With the above Vision and Mission, the designers of MEET-2k15 have devised the following learning objectives for the programme.

At the end of MEET-2k15 sessions, the attending participants will be able to:

- a) Identify and articulate a teaching-learning problem within their own teaching-learning activity.
- b) Design a technology enabled innovative solution to solve the identified teaching-learning problem.

In order to achieve the objectives given above, answer the following question:

Q1. Identify the topic in which you have the problem

1.a Break down the course that you are teaching to modules-topics and concepts

1.b Identify which of the following aspect of teaching-learning is relevant to your problem : Student learning, Student engagement and Student collaboration

Q2. Frame your teaching-learning problem

My problem is that ...

Q3. What is the solution to solve the problem

Q4. Why do you think that this problem is going to work?

Q1. Identify the topic in which you have the problem

Assembly language programming in the course Microprocessors and Microcontrollers

1.a Break down the course that you are teaching to modules-topics and concepts

Topic-Assembly Language Programming

1. Data Move instructions with MOV mnemonic
2. Arithmetic Logic instructions
3. Other data MOV instructions
4. Conditional and unconditional instructions

b Identify which of the following aspect of teaching-learning is relevant to your problem : Student learning, Student engagement and Student collaboration

1. Student Engagement
2. Student Learning
3. Student collaboration
4. Student collaboration

Q2. Frame your teaching-learning problem

To improve the conceptual understanding of assembly language programming

Q3. What is the solution to solve the problem

If you idea is on instructional strategies, briefly describe:

a) What will you do during the execution of the idea?

Explain the instruction with the help of simulator and give some code snippets to students to solve

b) What your students will do during the execution of the idea?

Listens to the lecture and solve the given problem sometimes individually and sometimes in group

c) What do you expect to improve due to your idea?

The conceptual understanding of the internals of execution of each instructions

Use 8051 simulator to explain the concepts (tool is going to be developed however)

a) What will the tool do?

The simulator will help the students

- to understand the concepts in the theory
- to understand the internals of execution of each and every instruction.

b) What inputs does the tool require?

Inputs in the form of assembly code snippets

c) What outputs will the tool produce?

The tool itself will not give any intermediate results, only the final execution

results. The students need to play around by using the same as a debugger in order to understand what happens inbetween

d) What is a user of the tool expected to do?

Students are expected to solve the problem using the simulator by

- Entering the code snippets given by the teacher
- Check the register values and memory values before and after the execution of each instruction
- Write in theory what happened after the execution of each instructions
- Check their answers with the book content

Q4. Why do you think that this problem is going to work?

It is a kind of reverse and practical learning. Instead of just listening to the theory and/or understands from the book this method makes the student to do something practically and to infer from what they did. This idea will work out with current generation students who do not have reading habit. Though the same thing should happen in the lab, the students never take interest themselves to learn the concept. Also in laboratory experiments the interest lays in the final outcome not the intermediate results.

 Add Discussion



Feedback

[pkarthikeyantce](#) Oct 24, 2015

In your idea execution steps, collaboration among the students is missing.



Comment



Diplai

[dipaliawasekar](#) Oct 24, 2015

I think solution need to framed properly as visulization are used to teach the concepts.
novelty of the solution needs to be worked.



[thangavelmuruganme](#) Oct 24, 2015

Dear Prof,

I hope for the question " Identify which of the following aspect of teaching-learning is relevant to your problem"...
Our facilitator advised to identify Maximum 2 and Minimum 1 aspect only...



Comment

IDEA - PROPOSAL

LEARNING OBJECTIVES

With the above Vision and Mission, the designers of MEET-2k15 have devised the following learning objectives for the programme.

At the end of MEET-2k15 sessions, the attending participants will be able to:

- a) Identify and articulate a teaching-learning problem within their own teaching-learning activity.
- b) Design a technology enabled innovative solution to solve the identified teaching-learning problem.

In order to achieve the objectives given above, answer the following question:

Q1. Identify the topic in which you have the problem

Design and manufacture of a theme based Automobile within a given time frame.

1.a Break down the course that you are teaching to modules-topics and concepts

1. Brakes
2. Suspension
3. Chasis
4. Electrical
5. Power train
6. Safety

1.b Identify which of the following aspect of teaching-learning is relevant to your problem :

1. Student learning
2. Student engagement
3. Student collaboration

Q2. Frame your teaching-learning problem

My problem is that..

1. Students lack design decision skills required for design manufacture and development t of real time automobile in a given timeframe
2. Student s are not able to decide the design of a theme based automobile

Q3. What is the solution to solve the problem

In order to assemble and manufacture the automobile

1. Divide group of students to work on a subsystem (eg. Brakes)
2. Integrate PjBL with flipped classroom

Q4. Why do you think that this problem is going to work?

1. Students will learn, understand the concepts by watching the videos
2. Instructor will facilitate to make design decision decisions
3. Discussion will be involved.

LEARNING OBJECTIVES

With the above Vision and Mission, the designers of MEET-2k15 have devised the following learning objectives for the programme.

At the end of MEET-2k15 sessions, the attending participants will be able to:

- a) Identify and articulate a teaching-learning problem within their own teaching-learning activity.
- b) Design a technology enabled innovative solution to solve the identified teaching-learning problem.

In order to achieve the objectives given above, answer the following question:

1. Identify the topic in which you have the problem -

- 1.a) Break down the course that you are teaching to modules-topics and concepts
- 1.b) Identify which of the following aspect of teaching-learning is relevant to your problem : Student learning, Student engagement and Student collaboration

Q.1 Majority of the students faces difficulty in learning of conceptual topics in computer architecture.

1.a) My problem is that some of the students are not able to comprehend the concept of dealing with deadlock in CPU scheduling.

1.b) Students Learning

Q.2 Frame your teaching-learning problem,

Idea is on instructional strategies, briefly describe:

- a) *What will you do during the execution of the idea?*
- b) *What your students will do during the execution of the idea?*
- c) *What do you expect to improve due to your idea?*

Active learning strategy will be deployed by flipping the classroom on topic for outside-class activity and TPS technique will be used in classroom for higher order cognitive thinking and discussion.

- a) I will post video clip and other reading material for the students on dealing with deadlock in CPU scheduling on padlet for students.
- b) My students will do the lower level learning at home by viewing the video clip, power point slide screen-cast and posted on padlet/ reading the material on CPU scheduling. In class activity will be targeted towards TPS and PI assignments.
- c) Students' learning shall improve.

Q.3. What is the solution to solve the problem?

By engaging students in active learning, using the tools/ technique such as padlet for information transmission as an outside class activity and TPS for class discussion and brainstorming on dealing with CPU scheduling

Q.4 Why do you think that this problem is going to work?

Because by using formative assessment approach on individual response by making the "moderate" option check in real time, I will evaluate the response of every student, before its approval. If more than one response found matching, students will be awarded no marks. I will be able to know what students have learned and what they have not.

After my approval, every response will be visible to all the students and they can match their response with their peers.

As a teacher, I will match learning outcome of the students' with their reflection. If happened to be a mismatch between the learning objective and outcome, I will re-align or modify the instructional strategy to reduce the gap.

 Add Discussion



Masoodhu Banu-Feedback
[banumobeen](#) Oct 24, 2015

In addition to using padlet for discussion small code segments also can be posted in the padlet and ask the students to execute and infer



Comment

IDEA - PROPOSAL

LEARNING OBJECTIVES

With the above Vision and Mission, the designers of MEET-2k15 have devised the following learning objectives for the programme.

At the end of MEET-2k15 sessions, the attending participants will be able to:

- a) Identify and articulate a teaching-learning problem within their own teaching-learning activity.
- b) Design a technology enabled innovative solution to solve the identified teaching-learning problem.

In order to achieve the objectives given above, answer the following question:

Q1. Identify the topic in which you have the problem

1.a Break down the course that you are teaching to modules-topics and concepts

Software engineering-SDLC-Analysis

1.b Identify which of the following aspect of teaching-learning is relevant to your problem : Student learning, Student engagement and Student collaboration

Students learning and students collaboration

Q2. Frame your teaching-learning problem

My problem is how to improve the students learning and students collaboration while learning the term analysis.

Q3. What is the solution to solve the problem

I can carry out the activities like giving a case study in a group of students and ask them to analyse the case study and jot down the problems they have identified in the case study. To make this solution novel we can conduct the case studies on padlets or by carrying out students collaboration i.e, conducting self and peer assessment for evaluation. Also I can ask students to start analysis based on simple real life problems.

Q4. Why do you think that this problem is going to work?

I think this solution should work out because it would be easy for me and students to understand the term analysis. Also the teaching strategies that I am going to use can be measured.

 Add Discussion

 regarding evaluation
[namratapatel](#) Oct 24, 2015

novel in evaluation

 Comment

IDEA - PROPOSAL

LEARNING OBJECTIVES

With the above Vision and Mission, the designers of MEET-2k15 have devised the following learning objectives for the programme.

At the end of MEET-2k15 sessions, the attending participants will be able to:

- a) Identify and articulate a teaching-learning problem within their own teaching-learning activity.
- b) Design a technology enabled innovative solution to solve the identified teaching-learning problem.

In order to achieve the objectives given above, answer the following question:

Q1. Identify the topic in which you have the problem

Object Oriented Concepts

1.a Break down the course that you are teaching to modules-topics and concepts

Inheritance - Class hierarchy

1.b Identify which of the following aspect of teaching-learning is relevant to your problem : Student learning, Student engagement and Student collaboration

- Student Learning
- Student Collaboration

Q2. Frame your teaching-learning problem

My problem is that to make the students to think the class hierarchy for implementing inheritance properly for the given problem

Q3. What is the solution to solve the problem?

The idea is on instructional strategy. That is Think-Pair-Share activity

My part during idea execution,

- Give problem to each team and make everyone to think about the class hierarchy and its operations

Students part during execution,

- During pair phase, insist the students to discuss their thoughts through wiki and comment others thoughts
- During share phase, discussion across the team for different problems

Expected improvement,

- Thinking of a problem with object oriented approach to implement the inheritance for the given problem

Q4. Why do you think that this problem is going to work?

The following steps will be considered during idea execution:

- Traditional chalk and talk with real-time examples (Lecture mode) and conduct a pre-test
- Think-Pair-Share Activity for a set of problems among the group of students through wiki and conduct a post-test
- Analysis based on the results from both tests to prove that this strategy is helpful in approach the problem for implementing the inheritance.

Outcome: To make everyone to participate in this collaborative activity based on their thoughts for the given problem

 Add Discussion

IDEA - PROPOSAL

LEARNING OBJECTIVES

With the above Vision and Mission, the designers of MEET-2k15 have devised the following learning objectives for the programme.

At the end of MEET-2k15 sessions, the attending participants will be able to:

- Identify and articulate a teaching-learning problem within their own teaching-learning activity.
- Design a technology enabled innovative solution to solve the identified teaching-learning problem.

In order to achieve the objectives given above, answer the following question:

Q1. Identify the topic in which you have the problem

Object Oriented Concepts

1.a Break down the course that you are teaching to modules-topics and concepts

Inheritance - Class hierarchy

1.b Identify which of the following aspect of teaching-learning is relevant to your problem : Student learning, Student engagement and Student collaboration

- Student Learning
- Student Collaboration

Q2. Frame your teaching-learning problem

My problem is that to make the students to think the class hierarchy for implementing inheritance properly for the given problem

Q3. What is the solution to solve the problem?

The idea is on instructional strategy. That is Think-Pair-Share activity

My part during idea execution,

- Give problem to each team and make everyone to think about the class hierarchy and its operations

Students part during execution,

- During pair phase, insist the students to discuss their thoughts through wiki and comment others thoughts
- During share phase, discussion across the team for different problems

Expected improvement,

- Thinking of a problem with object oriented approach to implement the inheritance for the given problem

Q4. Why do you think that this problem is going to work?

The following steps will be considered during idea execution:

- Traditional chalk and talk with real-time examples (Lecture mode) and conduct a pre-test
- Think-Pair-Share Activity for a set of problems among the group of students through wiki and conduct a post-test
- Analysis based on the results from both tests to prove that this strategy is helpful in approach the problem for implementing the inheritance.

Outcome: To make everyone to participate in this collaborative activity based on their thoughts for the given problem

 Add Discussion



Feedback

thangavelmuruganme Oct 24, 2015

Dear Prof,

During Think Phase, You may insist the students to post their ideas in Wiki and then you may ask the team to address remaining all teams problem statements. The above logic may create the ability of a team to gain the knowledge of different set of problems given in the class.

And During Share Phase, we may ask one team to share the problem solution of other team, which may create the responsibility and interest during pair phase.

In order to improve the novelty, You may ask students to use tools to draw the class diagram alone...



Comment

Indian Institute of Technology Bombay

IDP in Educational Technology

Idea Proposal

Q1. What teaching-learning problem are you trying to solve?

The problem is to find the effectiveness of course-tied bilingual discussion forum during the pre-semester exam break.

1.a Break down the course that you are teaching to modules-topics and concepts

Course name: Principles of Programming Languages(PPL)

Modules: Four modules as prescribed in the University syllabus in the subject of PPL.

1.b Identify which of the following aspect of teaching-learning is relevant to your problem :

Student learning: Asynchronous course-tied discussions encourage the students to discuss about they have not understood or they have a difficulty in or they find it important from the examination point of view. Effective learning takes place as the discussions happen with peers and with the instructor as well.

Student engagement: Since it is the asynchronous mode of interaction and used at the prime time during semester exam preparation break , active engagement is expected.

Student collaboration: Peer learning and instructor facilitated sets a good quality collaborative model

Q2. What is your idea to solve the problem?

a) What will the tool do?

The tool is a asynchronous bilingual course-tied discussion forum encouraging discussions during pre semester exam break.

b) What inputs does the tool require?

Unstructured text discussions

c) What outputs will the tool produce?

Characteristics from the discussions

d) What is a user of the tool expected to do?

Participate actively in the discussions.

Q3. How do you know if your idea is likely to work?

Describe the educational study that you can do to test your idea. Indicate what you will measure to gather scientific evidence, and how you will measure it.

I plan to conduct a test based on the syllabus of the PPL paper before I open the discussion forum for use to the students. I then let them actively interact on the forum in English and Konkani language. I plan to then conduct the same test paper and do the comparative analysis.

 Add Discussion

 pre exam break
[Roopal_Mamtora](#) Oct 24, 2015

would the tool be of good help during the crucial exam break when intense self study is required?

 Comment

IDEA - PROPOSAL

LEARNING OBJECTIVES

With the above Vision and Mission, the designers of MEET-2k15 have devised the following learning objectives for the programme.

At the end of MEET-2k15 sessions, the attending participants will be able to:

- a) Identify and articulate a teaching-learning problem within their own teaching-learning activity.
- b) Design a technology enabled innovative solution to solve the identified teaching-learning problem.

Inorder to achieve the objectives given above, answer the following question:

Q1. Identify the topic in which you have the problem

1.a Break down the course that you are teaching to modules-topics and concepts

Course: Information Retrieval

Topic: Information Retrieval Models

1.b Identify which of the following aspect of teaching-learning is relevant to your problem : Student learning, Student engagement and Student collaboration

Aspect : Student learning

Q2. Frame your teaching-learning problem

My problem is that Students are not able to implement information retrieval models.

Q3. What is the solution to solve the problem

Flipped classroom and peer instruction method.

i will create videos using screencast for information retrieval models.

1. Teacher will teach the topic information retrieval models.
2. Teacher will conduct peer instruction based on that topic.
3. Students will watch the video for the topic information retrieval models.
4. More Discussions on that topic.
5. Students will implement assignment in laboratory.

Above experiment can be conducted for two topics: Boolean model and vector model

Q4. Why do you think that this problem is going to work?

1. From the results of peer instruction, we can identify how many students have understood the concept
2. In discussion, we can find out how many students are taking part in the discussion?
3. How many students were able to complete the assignment?

 Add Discussion



Dipali

[dipaliwasekar](#) Oct 24, 2015

Is it only student learning that will be addressed.
how will the tracking of assignment be done.



Comment

IDEA - PROPOSAL

LEARNING OBJECTIVES

With the above Vision and Mission, the designers of MEET-2k15 have devised the following learning objectives for the programme.

At the end of MEET-2k15 sessions, the attending participants will be able to:

- a) Identify and articulate a teaching-learning problem within their own teaching-learning activity.
- b) Design a technology enabled innovative solution to solve the identified teaching-learning problem.

In order to achieve the objectives given above, answer the following question:

Q1. Identify the topic in which you have the problem

1.a Break down the course that you are teaching to modules-topics and concepts

1.b Identify which of the following aspect of teaching-learning is relevant to your problem : Student learning, Student engagement and Student collaboration

In Electronic Commerce, I have taken a topic Strategies for E-Business.

Q2. Frame your teaching-learning problem

Problem is that students find it boring and not getting engaged to learn the concept.

Q3. What is the solution to solve the problem

To use videos, Multiple choice questions, simulations to teaching them. After class discussions on Padlet, wikispaces

Q4. Why do you think that this problem is going to work?

If students get engaged via after lecture and discussions. They will have better understanding. They will get lot of material to study before exams and better understanding.

Add Discussion



Flipped Classroom
bthangagiri Oct 24, 2015



Dear Mr.mudit Kapoor,
Can you try for flipped classroom activity for your class. I think it is better because the student will come with pre-idea of your classroom topics. Then they will take more interaction with you in class.
Regards,
B.Thangagiri



Comment



Feedback

thangavelmuruganme Oct 24, 2015



Dear Prof,
I hope usage of Videos, and simulations to teach is an obvious solution.
How to consider the solution to be Novel?

For the question "What is your idea to solve the problem? "
The answer must be describe whether your solution belongs to instructional strategies or developing a tool.

And for the question "Why do you think that this problem is going to work?"
It is advised by our facilitator to highlight the measurement and evidence collection towards ET Research.



vinitakhatri Oct 24, 2015

Dear Sir,

If the students are finding the topic boring you can explain the theory part by taking the experimental part alongwith it. To get the evidence within the class you can tell them to do any task which carries marks step by step.
In this way u will get the evidence, but to check is it unique or not, literature survey should be there.

Regards
Vinita



er.mudit Kapoor Oct 24, 2015

@Thangagiri

Sir, I have used that video, simulation. I am trying to use it with tool that is not used by others , searched literature.

@Vinita

Ma'am, I have checked Padlet on IEEE, nobody used it for that type of work.



er.mudit Kapoor Oct 24, 2015

@thangavelmuruganme

Sir, I will measure this with the help of the discussions with valid reasons and collaborations.



Comment

IDEA - PROPOSAL

LEARNING OBJECTIVES

With the above Vision and Mission, the designers of MEET-2k15 have devised the following learning objectives for the programme.

At the end of MEET-2k15 sessions, the attending participants will be able to:

- a) Identify and articulate a teaching-learning problem within their own teaching-learning activity.
- b) Design a technology enabled innovative solution to solve the identified teaching-learning problem.

In order to achieve the objectives given above, answer the following question:

Q1. Identify the topic in which you have the problem

Ans: Structured object oriented analysis and design-analysis phase for use-case approach.

Q2. Frame your teaching-learning problem

Ans: My problem is to improve, that the student should be able to apply the different relationships in the use-cases for given real-time problem

Q3. What is the solution to solve the problem

Sol1: Taking variety of problems that would cover the three types of relationships

Sol2: TPS

Q4. Why do you think that this problem is going to work?

Sol: As because of emphasizing more upon real-time problem and tps students would be able apply the different relationship .

 Add Discussion



Problem domain

kalyaninp Oct 24, 2015

I think my peer need to be rethink on very specific problem domain.



Comment

With the above Vision and Mission, the designers of MEET-2k15 have devised the following learning objectives for the programme.

At the end of MEET-2k15 sessions, the attending participants will be able to:

- a) Identify and articulate a teaching-learning problem within their own teaching-learning activity.
- b) Design a technology enabled innovative solution to solve the identified teaching-learning problem.

In order to achieve the objectives given above, answer the following question:

Q1. Identify the topic in which you have the problem

Geometric Modeling

1.a Break down the course that you are teaching to modules-topics and concepts

Course: Geometric Modeling	
Modules	Concepts
Coordinate system	Geometrical based
	Display based
Synthetic Curves	Hermite
	Bezier
	B spline
Transformation	3D Translation
	3D Scaling
	3D Rotation
	3D Mirror
	Multiple transformation

1.b Identify which of the following aspect of teaching-learning is relevant to your problem : Student learning, Student engagement and Student collaboration

Topic	Students learning	Students engagement	Students collaboration
Coordinate system			
Geometrical based	X	X	
Synthetic Curves			
Hermite or Bezier	X	X	X
Transformation			
3D Transformation	X		
Multiple transformation	X	X	X

Q2. Frame your teaching-learning problem

My problem is that Students cannot understand mathematical relation with geometrical shapes and its transformations.

Q3. What is the solution to solve the problem

Bridge course in basic Mathematics

Student are advised to draw the 2D shapes using graph sheet.

Generate the curve shape by implementing the mathematical equations and change the input (parameter) in order to view the change of resultant curve shape by visualization (e.g) using computer software, Excel.

Q4. Why do you think that this problem is going to work?

Lecture class - students can understand the theory part of concept.

Activity - Think Pair share

Think phase - students need to think the need of importance of geometrical relation with mathematical modeling.

Pair - Students are grouped and solve the problem in traditional graph sheet and programming in Microsoft Excel

Share - Group need to explain the characteristics of geometrical modeling

Through visualization students can understand the characteristics of geometrical shape.

Outcome: Students can relate with mathematical description with geometrical shapes and transformation of geometry.

 Add Discussion



Idea execution feedback
pkarthikeyantce Oct 24, 2015

Dear Prakash, The term understand is very vague. How will you measure it? Again you have mentioned about the visualization techniques to support your problem through traditional way. Obviously yes. But I think this is not an innovative solution. May be you can add little bit more on this.



pkarthikeyantce Oct 24, 2015
You have mentioned the TPS activity. Its a collaborative work also. You can also map your problem with students collaboration.



Comment

Outcome: Students can relate with mathematical description with geometrical shapes and transformation of geometry.

 Add Discussion



Idea execution feedback
pkarhikeyantce Oct 24, 2015

Dear Prakash, The term understand is very vague. How will you measure it? Again you have mentioned about the visualization techniques to support your problem through traditional way. Obviously yes. But I think this is not an innovative solution. May be you can add little bit more on this.



pkarhikeyantce Oct 24, 2015
You have mentioned the TPS activity. Its a collaborative work also. You can also map your problem with students collaboration.



Comment



Making rel models of the simple object
bthangagiri Oct 24, 2015

Dear Mr.Prakask,
Ask the students to build the basic real models of the 3D objects and bring them into your class which helps to understanding of the synthetic curves and their equation still clear.
Regards,
B.Thangagiri



Comment

IDEA - PROPOSAL

LEARNING OBJECTIVES

With the above Vision and Mission, the designers of MEET-2k15 have devised the following learning objectives for the programme.

At the end of MEET-2k15 sessions, the attending participants will be able to:

- Identify and articulate a teaching-learning problem within their own teaching-learning activity.
- Design a technology enabled innovative solution to solve the identified teaching-learning problem.

In order to achieve the objectives given above, answer the following question:

Q1. Identify the topic in which you have the problem

ANS: Software Engineering

1.a Break down the course that you are teaching to modules-topics and concepts

1.b Identify which of the following aspect of teaching-learning is relevant to your problem : Student learning, Student engagement and Student collaboration

ANS 1a)

Module:SDLC

Topic: type of model

Concept:RAD

ANS 1b)

Student learning

Q2. Frame your teaching-learning problem

My problem is that ...

ANS:students should be able to identify which SDLC model should be applicable to a given real world problem

Q3. What is the solution to solve the problem

ANS :

- asking the students to take the commonest example from their area of interest
- try to apply the concept to it and make them understand.
- ask students to collaborate using wikispaces.

Q4. Why do you think that this problem is going to work?

ANS:

- since students come out with their area of interest , they will have complete knowledge of the same and show interest in terms of giving response
- will give a quick understanding .

IDEA - PROPOSAL**LEARNING OBJECTIVES:**

With the above Vision and Mission, the designers of MEET-2k15 have devised the following learning objectives for the programme.

At the end of MEET-2k15 sessions, the attending participants will be able to:

- Identify and articulate a teaching-learning problem within their own teaching-learning activity.
- Design a technology enabled innovative solution to solve the identified teaching-learning problem.

In order to achieve the objectives given above, answer the following question:

Q1. Identify the topic in which you have the problem

The better understanding of Engineering Chemistry theory as well as Engineering Chemistry laboratory experiments of first year undergraduate engineering students

1.a Break down the course that you are teaching to modules-topics and concepts

Course name: Engineering Chemistry and Engineering Chemistry Laboratory

Modules: Analysis of water content like hardness, alkalinity and chemical oxygen demand,

Construction and measurement of EMF of different electro-chemical cells

1.b Identify which of the following aspect of teaching-learning is relevant to your problem : Student learning, Student engagement and Student collaboration

Student learning, Student engagement and Student collaboration.

	Student learning	Student engagement	Student collaboration
Analysis of water content			
1. Hardness	X	X	
1. Alkalinity	X	X	
Construction and measurement of EMF			
1. Electrochemical cell	X	X	X
1. Electrolytic cell	X	X	X



Q2. Frame your teaching-learning problem

My problem is that to make the first year undergraduate student to make better understanding of Engineering Chemistry laboratory courses in connection with Engineering Chemistry theory course.

Q3. What is the solution to solve the problem

I am going to use the virtual chemistry laboratory for the better understanding of concept of Engineering Chemistry course with Engineering Chemistry laboratory course.

Q4. Why do you think that this problem is going to work?

The virtual Chemistry laboratory makes better understanding of Engineering Chemistry laboratory experiments. This is because these virtual chemistry laboratory experiments can be do without Teaching faculty and lab assistant by students, with many times without need of chemicals, glassware and environmental hazards and costly equipments in engineering chemistry laboratory.

 Add Discussion



MuditKapoor_IPA

[er.muditkapoor](#) Oct 24, 2015

Your solution looks good. You can include some sort of real time example with the help of small act in collaboration with students, if you like.
Increase collaboration by using some tool like wikis, etc in lecture.



Comment



Prakash
tprakshtce Oct 24, 2015



Dear Sir

main Problem is that students cannot understand the chemical reaction. How you measure the students understanding



bthangagiri Oct 24, 2015

Dear Mr.Prakask,
I will measure the level of understanding by scores from the pre-test and post-test for the students.



thangavelmuruganme Oct 24, 2015

Dear Prof,
How will you measure the term "Understanding"?
How will you create evidence for ET Research using Virtual Chemistry Laboratory?
Using the Existing Virtual Chemistry Laboratory may be the Obvious solution! So, What is the Novelty in your solution?
How will make the students engaged in the topic using Virtual Chemistry Lab?! How will you measure it?!



bthangagiri Oct 24, 2015

Dear prof.,
I am going to use unique tool which is developed by Amirtha University.
I will measure the level of understanding by pre-test and post-test.
Regards,
B.Thangagiri



Comment

IDEA - PROPOSAL

LEARNING OBJECTIVES

With the above Vision and Mission, the designers of MEET-2k15 have devised the following learning objectives for the programme.

At the end of MEET-2k15 sessions, the attending participants will be able to:

- a) Identify and articulate a teaching-learning problem within their own teaching-learning activity.
- b) Design a technology enabled innovative solution to solve the identified teaching-learning problem.

In order to achieve the objectives given above, answer the following question:

Q1. Identify the topic in which you have the problem

Cryptography Course

1.a Break down the course that you are teaching to modules-topics and concepts

AES Cryptosystem

1.b Identify which of the following aspect of teaching-learning is relevant to your problem : Student learning, Student engagement and Student collaboration

Student Learning

Student Engagement

Q2. Frame your teaching-learning problem

My problem is that ...

I want my different types of learner's to understand and solve AES Cryptosystem.

Q3. What is the solution to solve the problem

Developing a Cryptology Educational tool for solving AES Cryptosystem.

a) What will the tool do?

Tool will help the students

- to understand the flow and also
- to solve each and every step and round involved in AES Cryptosystem.

b) What inputs does the tool require?

Inputs of AES Cryptosystem

- Key Expansion - i/p will be Key of 128 bit size.
- Encryption - i/p will be Plaintext of 128 bit size.
- Decryption - i/p will be Ciphertext of 128 bit size.

User i/p is required to move from one step to another step in the AES Cryptosystem.

c) What outputs will the tool produce?

Input, input processing step, Intermediate result, and Final result.

AES Cryptosystem (Key Expansion, Encryption and Decryption) is divided into 10 Blocks each. And Each block has been subdivided to sub-blocks.

Key Expansion - 3 Sub-Blocks

Encryption & Decryption - 4 Sub-Blocks

In the Output, Each sub-blocks Input, input processing step, Intermediate result, and Final result will be projected.

d) What is a user of the tool expected to do?

Students are expected to solve the problem using tool by.

1. Giving the necessary i/p's
2. learn the flow of the cryptosystem
3. learn the solution steps involved in each and every step in the cryptosystem
4. Manually solve the problem
5. Verify the results with the tool.

IDEA - PROPOSAL

LEARNING OBJECTIVES

With the above Vision and Mission, the designers of MEET-2k15 have devised the following learning objectives for the programme.

At the end of MEET-2k15 sessions, the attending participants will be able to:

- a) Identify and articulate a teaching-learning problem within their own teaching-learning activity.
- b) Design a technology enabled innovative solution to solve the identified teaching-learning problem.

In order to achieve the objectives given above, answer the following question:

Q1. Identify the topic in which you have the problem

Ans. Optics

Q2. Frame your teaching-learning problem

Ans. My problem is less engagement of students in lectures for basic science subjects.

Q3. What is the solution to solve the problem?

Ans. Along with the traditional technique of teaching, any tool or simulation can be incorporated so that students can practically get the same solution by themselves, and a survey can be done to get the evidence. Enough literature survey has to be done to get a unique solution

Q4. Why do you think that this problem is going to work?

Ans. The problem is not unique, but if the solution is novel it will be the best one to get solved, as in every lecture these problems are common. Students will also get benefit.

 Add Discussion



MuditKapoor_IPA
er.muditkapoor Oct 24, 2015

This idea looks good. I think if you use some simple tools like wikis or etc in class, so that students get engage in that activity.

You can also perform some sort of act to visualize the concept with the help of 4-5 students, if possible.



vinitakhatri Oct 24, 2015

dear sir,
thanks, the technologies that i will use includes wiki, padlet etc.



Flipped class room concept
bthangagiri Oct 24, 2015

Dear Ms.Vinita,

Can you tried for flipped classroom activity for your class. I think it is better because the student will come with pre-idea of your classroom topics. Then they will take more interaction with you in class.

Regards,

B.Thangagiri



Comment

APPENDIX F – Study Planning by participants during Iteration 4

[Banu.N.M-SPA-2](#)

Planning your Research Study

The research study plan has three parts: Setting up the Problem, Explanation of Intervention/Solution and Description of the study

Setting up the Problem

Setting up of the problem starts from the teaching-learning goal and then tries to provide characteristics of the problem in terms of related work.

1. What problem are you addressing?

Describe the details of a teaching-learning scenario

Students from state board in school do mere rote learning.

1. Conceptual understanding for such students is very less
2. Find difficulty to relate mathematics they learnt with engineering courses they study
3. Though some students come to conceptual understanding, higher order learning skill is below average

2. Why is your problem important?

Show evidence (using data) that the problem exists for your target population or users.

- Students never able to answer modulation in their own sentence, if they do it never used to be correct.
- Though they use trigonometry formulas in deriving equation what is learnt in the class, they don't apply it if a new problem scenario is given.

3. Summarize gaps in prior work

Earlier works that I have seen is signals and systems and have not come across any paper related to analog communication.

Explanation of Intervention/Solution

What is your solution approach?

1. The development of instructional material and methods that support student learning
2. Carefully designed test questions in the higher cognitive level to assess the learning

Explain the relation of your solution to related prior work

You would need to show how your solution is different or better than existing work. Answer:

Multiple gaps have not been identified yet

The earlier work done with signals and systems is to map instructional strategies with visualizations to micro level instructional objectives to ensure the objective is successfully attained

4. What are the details of your learning materials or tool?

- **If your solution is related to instructional strategies:**

The learning materials are carefully designed instructional strategies for available/created visualizations or simulation to understand the concepts of each topic

Example: How changing the carrier frequency results in change in the amplitude modulation spectrum (more examples will be given later)

Instructional strategies to infuse higher order learning skill (Introducing problem within the FM receiver to identify the problem)

5. What are the boundaries of your solution?

State the boundaries of your solution

The boundaries could be related to:

1.The idea is to give lot of take home problems. However the group I am targeting never used to do. Creating interest is one part and the other one is resource for in class activities.

(One student with one desktop is a constraint), Number of available visualization

2. If the tests are part of internals fear of more attrition from the group. If separately done time restriction.

Description of the study

1. What is your Research Design?

•Single Group Pre-post test design. • Suitable because it evaluates the scores before and after treatment to identify if there is any change happened in the positive direction

2. What is your sample?

Detail the sample, who are the subjects in your study or users of your tool? How will you select the sample?

What is your sample, that is, who are the subjects in your study or users of your tool?

II year ECE students from SB syllabus

2)How will you select your sample?

3)Why is your sample and your sampling strategy suitable?

My sample is suitable here as all are from state board syllabus, where they never try to learn instead they try to score marks. The exam pattern also motivates this. This set of students when they are given an opportunity to learn with activities, their attention is improved.

3. What is the procedure for your study?

Give sufficient detail about the procedure conducted for your study so that your colleague can replicate it.

What will you do during the execution of the idea?

Explain every concept using visualizations with inquiries in-between

What your students will do during the execution of the idea?

Listens to the step to be followed and solve the given problem

sometimes individually and sometimes in group

What do you expect to improve due to your idea?

The conceptual understanding of each modulation

4. What is your research study question?

Recall the rules for framing Research Questions in the session

1. Does the use of visualizations/simulations enhances conceptual understanding in analog communication
2. Does it paves the way for higher order learning skills ?
3. Does the problem based learning improves higher order learning skills

5. What are your measurements?

You would have to answer the following questions:

- What will you measure in your study?
- How can you justify that these measurements are suitable to answer the problem you intend to solve?

The score range before and after treatment. Frequency distribution within each range before and after treatment

6. What are your instruments?

You would have to describe:

- What are the instruments (such as questionnaires, tests) you will use to collect the data?
- Why are the instruments suitable for your study?
- How robust are the instruments? That is, what kind of reliability and validity test can you show?

•Instruments Used•Pre test and post test•Class room observation

•Reliability:

Questions will be on what they learnt through simulations/visualizations but may be in a different form i.e. in higher blooms level like applying and analysis

7.How do you plan to analyze your data?

You will have to answer this question on the following lines:

Which descriptive statistics could you use to present the data in an organized manner? (such as means, histograms, correlations, etc.)

Mean of the pre and post test score

Will you show frequency distributions? % of students under each stratum before and after treatment.

Think about median here whether it really works.

What analysis could you do to draw inferences, that is, to establish that your idea works? Write which statistical tests you will apply, and what exactly you can infer from the test.

Probability density function of scores. If more lies on the right side of the average , it gives visual indication that the idea works out

8.What ethical guidelines will you follow for conducting research with human subjects?

Write what ethical guidelines you will consider (such as asking participants to give informed consent), since you are conducting research with human subjects.

It will be an informed session

 Add Discussion

 POGIL design
[banumobeen](#) Dec 15, 2015

Dear Jayakrishnan,

How about designing POGIL classes for analog communication course?
Banu

 [Jkiitb](#) Jan 21, 2016
It would be a good idea, however if its just an implementation of POGIL that may not have sufficient novelty.

 Comment

Planning your Research Study

This page helps you in articulating the plan for your educational research study. This follows the Idea Proposal Assignment and hence it is important that you complete IPA before attempting this.

The research study plan has three parts: Setting up the Problem, Explanation of Intervention/Solution and Description of the study

Setting up the Problem

Setting up of the problem starts from the teaching-learning goal and then tries to provide characteristics of the problem in terms of related work.

1. What problem are you addressing?

Describe the details of a teaching-learning scenario

Students from state board in school do mere rote learning. For them programming is a nightmare and assembly language programming is of more difficulty

2. Why is your problem important?

You should be able to argue (based on literature survey), or show evidence (using data) that the problem exists for your target population or users.

Have explained the function of PUSH and POP and solved ½ problem related to that in the class. However when similar question was asked in the internal test they did not attempt the question or answered wrongly. Same thing as a theoretical question most of the students got it right

3. Summarize gaps in prior work

Prior works are all about high level programming languages only, where the students/programmer don't have to consider the hardware.

Explanation of Intervention/Solution

1. What is your solution approach?

Describe the details of your solution approach

1. Experimental codes designed to play around in the simulators-will allow students to

- conduct experiments through operating the simulations
- collect experimental data,
- correct their assumptions through timely feedback from instructors and
- discuss with their group members.

2. Carefully designed test questions in the higher cognitive level to assess the learning

2. Explain the relation of your solution to related prior work

You would need to show how your solution is different or better than existing work. Answer:

- Which gap listed above is your solution attempting to address?
- Does your solution extend existing work?

(or)

- Does your work provide an alternative solution?

Need to do little more literature review on it

3. Why is your method likely to work?

Defend your solution approach (treatment/tool) using logical arguments. You would have to convince :

- Is your treatment strategy or tool solving the problem?

Treatment strategy

- Is this treatment even worth experimenting?

YES

Using interactive simulations in the inquiry process is believed to have the potential to make scientific concepts more intelligible and plausible -soundness

It is similar to kids learning to play games in the mobile phone just by playing around the keypad

4. What are the details of your learning materials or tool?

- **If your solution is related to instructional strategies: Describe what you will create as learning materials**

The learning materials are carefully designed code snippets to understand the concepts of each topic

Example: How a code written with improper PUSH and POP operations will affect the code flow

(Example code will be explained with the help of simulator)

- If you are developing a tool:

Describe detailed feature that are relevant to the user.

Describe the architecture/model used.

5. What are the boundaries of your solution?

State the boundaries of your solution

The boundaries could be related to:

Domain (for ex: is my strategy /tool applicable to a specific topic/subject)

Sample (for ex: is my strategy/tool targeting a specific group)

Environment or context (for ex: am I assuming that my learning materials are to be used without teacher being present)

...etc

1. The idea is to give lot of take home problems. However the group I am targeting never used to do. Creating interest is one part and the other one is resource for in class activities.

(One student with one desktop is a constraint)

2. If the tests are part of internal fear of more attrition from the group. If separately done time restriction.

Description of the study

1. What is your Research Design?

- Single Group Pre-post test design.
- Suitable because it evaluates the scores before and after treatment to identify if there is any change happened in the positive direction

2. What is your sample?

Detail the sample, who are the subjects in your study or users of your tool? How will you select the sample?

What is your sample, that is, who are the subjects in your study or users of your tool?

III year ECE students from SB syllabus

2)How will you select your sample?

3)Why is your sample and your sampling strategy suitable?

Generally kids of age 3/4 start playing games in mobile phones. They learn of their own by playing around the keys. Only thing needed initially is to switch on and off functions and menu choosing functions and either they learn from parents or by seeing them doing it.

Hence this can be applied to any groups

3. What is the procedure for your study?

Give sufficient detail about the procedure conducted for your study so that your colleague can replicate it.

What will you do during the execution of the idea?

Explain each instruction with the help of simulator and give some code

snippets to students to solve

What your students will do during the execution of the idea?

Listens to the step to be followed and solve the given problem

sometimes individually and sometimes in group

What do you expect to improve due to your idea?

The conceptual understanding of the internals of execution of each instructions

4. What is your research study question?

Recall the rules for framing Research Questions in the session

1. Does the use of simulator enhances the assembly language programming skill ?
2. What is the impact of this treatment on higher learners

5.What are your measurements?

You would have to answer the following questions:

- What will you measure in your study?
- How can you justify that these measurements are suitable to answer the problem you intend to solve?

The score range before and after treatment. Frequency distribution within each range before and after treatment

Planning your Research Study

This page helps you in articulating the plan for your educational research study. This follows the Idea Proposal Assignment and hence it is important that you complete IPA before attempting this.

The research study plan has three parts: Setting up the Problem, Explanation of Intervention/Solution and Description of the study

Note: The below line of text is only for demonstration of use of anchor in Wiki. You may delete it after you have understood the idea.

I am trying to link to a section at the bottom of this page which I have already anchored as "[instruments](#)"

Part - 1: Setting up the Problem

Setting up of the problem starts from the teaching-learning goal and then tries to provide characteristics of the problem in terms of related work.

1. What problem are you addressing?

Some of the students are not able to comprehend the concept of deadlock in CPU scheduling. After chalk-talk-show instructional strategy, students nodded that they have learnt the deadlock in CPU scheduling by operating system. But they are not able to answer the most basic question, slightly twisted, the real life resource deadlock when it is shared among contenders.

2. Why is your problem important?

Theoretical knowledge is important to understand the multi-tasking. Final year students should be able to think the same in similar real life scenario. The whole topic is based in dealing with resource management.

3. Summarize gaps in prior work <--- This is where the Anchor "Gaps" point to

There is established literature for improving conceptual understanding to most of the subjects. The problem of conceptual understanding is not addressed in computer science subject more often.

"ELEARNING AND ECONOMICS - DIGGING A LITTLE DEEPER" APPLE DISTINGUISHED EDUCATOR 2011

"Padlet fits very nicely with ideas around both collaboration and formative assessment. Especially the idea of setting a quick task to elicit evidence of understanding. Because Padlet requires no-student log in it is an unobtrusive activity in task that seldom breaks the learning routine." Andrew McCarthy

Part - 2: Explanation of Intervention/Solution

1. What is your solution approach?

My idea is to use Flipped classroom technique using padlet to improve their conceptual understanding and will be able to undertake formative assessment again using padlet

Process will be as follows:

As a teacher _

1. I have taught the deadlock concept using traditional teaching. Learnt low understanding of topic.
2. I will transfer the information in the form of video and other study material using padlet for an out-side class activity.
3. I will make the students to respond what they learnt after watch video/ reading notes on topic. I will instigate higher order thinking among the students by posing the question on padlet in in-side class.
4. I will conduct TPS quiz inside the class. Students shall do brainstorming and participate in discussion.

2. Explain the relation of your solution to related prior work

There are many solutions to make the students learn. But there is no formative assessment on learning outcome except summative assessment at the end of the course.

3. Why is your method likely to work?

Because by using formative assessment approach on individual response by making the "moderate" option check in real time, I will evaluate the response of every student, before its approval. If more than one response found matching, students will be awarded no marks. I will be able to know what students have learned and what they have not.

After my approval, every response will be visible to all the students and they can match their response with their peers. As a teacher, I will match learning outcome of the students' with their reflection. If happened to be a mismatch between the learning objective and outcome, I will re-align or modify the instructional strategy to reduce the gap.

4. What are the details of your learning materials or tool?

Video link, power point show screen-cast, reading material, Padlet, Quiz for TPS

5. What are the boundaries of your solution?

Strategy focuses on first year students having no prior knowledge.

Part - 3: Description of the study

1. What is your Research Design?

- Single class post-post year-on-year test design
- Suitable because it compares the scores between two different approaches for a change happened in the positive direction

2. What is your sample?

- Sample Size - 60
- Sample Selection - Stratified (First year CSE students)

3. What is the procedure for your study?

1. Chalk-Talk-Show as a part of Learning
2. Traditional Teaching inside the classroom
3. Watching video outside classroom
4. Doubt clearing, queries and discussion phase using TPS
5. Implementation phase

4. What is your research study question?

RQ - 1: Does collaborative learning platform of Padlet help in students' conceptual understanding?

RQ - 2: How effective is padlet for the purpose of formative assessment?

5. What are your measurements?

1. Formative Assessment outcome
2. Students' engagement with padlet
3. Survey questionnaire
4. Examination results

☆ Kavita_CTD_SPA

 Edit  1  2 ...

PFA my proposed SPA in the uploaded CTD_SPT.ppt file.



CTD_SPT.pptx

[Details](#) [Download](#) 290 KB

Looking forward to the remarks. I am continuing to work on the same and will report the progress.

 Add Discussion



Feedback Comments

[Jkiitb](#) Nov 4, 2015

You may have to define what you mean by "effective" in your research question. Effectiveness of the CTD can be measured through various metrics, like Frequency of interactions, Quality of Interactions etc. Putting this clearly in RQ helps you in aligning the measurement. Also, do not look for causal relations with learning initially. Students exam performance may be improved due to a variety of reasons. CTD's will be only one such variable.

Also since you are creating a tool to facilitate the discussion, not sure whether learning should be your primary target. Again here you may have to compare the tool with a standard LMS which provides most of these features. Your research design may have to be more qualitative (look into content or discourse analysis) as is common in online discussions. So you should analyze more works related to Asynchronous Online Discussions and see standard methods and research questions asked in them.

I didn't see any slides after the Research Design (slide 10). So I hope the next iteration will have the full details.



Comment

Planning your Research Study

This page helps you in articulating the plan for your educational research study. This follows the Idea Proposal Assignment and hence it is important that you complete IPA before attempting this.

The research study plan has three parts: Setting up the Problem, Explanation of Intervention/Solution and Description of the study

Setting up the Problem

Setting up of the problem starts from the teaching-learning goal and then tries to provide characteristics of the problem in terms of related work.

1. What problem are you addressing?

Students are expected to implement information retrieval models in lab session after learning in theory class.

But they are not able to implement information retrieval models even after they are saying that they have understood.

2. Why is your problem important?

- Program writing skills are important for IT engineer.
- Final year students should be in a position to write a program for taught concepts.
- Whole course is based on information retrieval models so it is necessary that students should be able to implement/ write program for information retrieval models.

3. Summarize gaps in prior work

There is established literature for improving programming skills, conceptual understanding of programming language.

It is not applied to course information Retrieval.

Explanation of Intervention/Solution

1. What is your solution approach?

My idea is to use Flipped classroom and peer instruction method to improve their conceptual understanding and will be able to implement information retrieval models.

Process will be as follows:

1. Teacher will teach concept using traditional teaching.
2. Teacher will give the video for the same topic.
3. In next lecture, more discussions will be on the students' doubts after watching videos.
3. Teacher will conduct peer instruction based on that topic.
4. After peer instruction, students will implement assignment in laboratory.

2.Explain the relation of your solution to related prior work

3.Why is your method likely to work?

- Using flipped classroom, students can go through the topic as per his/her liberty.
- Students will be able to clarify their doubts as more discussion is happening in the class on their doubts.
- Teacher will design peer instruction questions which will lead to clarify students' concept.
- Single group pre-post study.

How to measure: Answers in peer discussion, no of students attempted correct answer in first attempt, second attempt, wrong answers in both attempts.
At the end, how many students have implemented program correctly.

4. What are the details of your learning materials or tool?

Videos will be created by the teacher so that environment in which they learnt topic will be same in the video.

Questions designed for peer instruction will help students to clarify their doubts.

5. What are the boundaries of your solution?

Strategy is targeting final year students having programming knowledge.

Description of the study

1. What is your Research Design?

RQ:

- Does integration of flipped classroom and peer instruction strategy improve students' conceptual understanding of information retrieval models?
- Does this integration helps students in implementing information retrieval models?

2. What is your sample?

- The sample for this study are final year engineering undergraduate students from information Technology discipline.

•Sample size : 50

3. What is the procedure for your study?

1. Learning Phase

- Traditional Teaching inside the classroom
- Watching video outside classroom.

2. Discussion Phase

Discussion will be based on the students' doubts.

3. Peer instruction phase

4. Implementation phase

4. What is your research study question?

RQ:

- Does integration of flipped classroom and peer instruction strategy improve students' conceptual understanding of information retrieval models?
- Does this integration helps students in implementing information retrieval models?

5.What are your measurements?

- Results of peer instruction method
- Rubrics for assessing implementation of information retrieval models.
- Survey questionnaire
- Final university practical/oral examination results.

6. What are your instruments?

- 1.Peer instruction questions
- 2.Rubrics for assessment
3. survey questionnaire

7.How do you plan to analyze your data?

- Peer instruction:
 1. no of correct answers in both phases
 2. no of changed answers
 3. no of incorrect answers in both phases
- Implementation = Rubric
- Survey= Statistical feedback and descriptive feedback

8.What ethical guidelines will you follow for conducting research with human subjects?

Write what ethical guidelines you will consider (such as asking participants to give informed consent), since you are conducting research with human subjects.

- Consent form from students.

 Add Discussion

Planning your Research Study

This page helps you in articulating the plan for your educational research study. This follows the Idea Proposal Assignment and hence it is important that you complete IPA before attempting this.

The research study plan has three parts: Setting up the Problem, Explanation of Intervention/Solution and Description of the study

Setting up the Problem

Setting up of the problem starts from the teaching-learning goal and then tries to provide characteristics of the problem in terms of related work.

1. What problem are you addressing?

You would need to expand the answer by:

Describe the details of a teaching-learning scenario

2. Why is your problem important?

You should be able to argue(based on literature survey), or show evidence (using data) that the problem exists for your target population or users.

3. Summarize gaps in prior work

Explanation of Intervention/Solution

1. What is your solution approach?

Describe the details of your solution approach

2.Explain the relation of your solution to related prior work

You would need to show how your solution is different or better than existing work. Answer:

- Which gap listed above is your solution attempting to address?
- Does your solution extend existing work?

(or)

- Does your work provide an alternative solution?

3.Why is your method likely to work?

Defend your solution approach (treatment/tool) using logical arguments. You would have to convince :

- Is your treatment strategy or tool solving the problem?
- Is this treatment even worth experimenting?

4. What are the details of your learning materials or tool?

- If your solution is related to instructional strategies:

Describe what you will create as learning materials

- If you are developing a tool:

Describe detailed feature that are relevant to the user.

Describe the architecture/model used.

5. What are the boundaries of your solution?

State the boundaries of your solution

The boundaries could be related to:

Domain (for ex: is my strategy /tool applicable to a specific topic/subject)

Sample(for ex: is my strategy/tool targeting a specific group)

Environment or context (for ex: am I assuming that my learning materials are to be used without teacher being present)

...etc

Description of the study

1. What is your Research Design?

2. What is your sample?

Detail the sample, who are the subjects in your study or users of your tool? How will you select the sample?

3. What is the procedure for your study?

Give sufficient detail about the procedure conducted for your study so that your colleague can replicate it.

4. What is your research study question?

Recall the rules for framing Research Questions in the session

5. What are your measurements?

You would have to answer the following questions:

- What will you measure in your study?
- How can you justify that these measurements are suitable to answer the problem you intend to solve?

6. What are your instruments?

You would have to describe:

- What are the instruments (such as questionnaires, tests) you will use to collect the data?
- Why are the instruments suitable for your study?
- How robust are the instruments? That is, what kind of reliability and validity test can you show?

7. How do you plan to analyze your data?

You will have to answer this question on the following lines:

- Which descriptive statistics could you use to present the data in an organized manner? (such as means, histograms, correlations, etc)
- What analysis could you do to draw inferences, that is, to establish that your idea works? Write statistical tests you will apply, and what exactly you can infer from the test.

8. What ethical guidelines will you follow for conducting research with human subjects?

Write what ethical guidelines you will consider (such as asking participants to give informed consent), since you are conducting research with human subjects.

 Add Discussion

Explanation of Intervention/Solution**1. What is your solution approach?**

Describe the details of your solution approach

ANS:

- 1) I propose an idea of using "Peer Assessment of program" to be implemented in lab session using an IDE with Collaborative feature.
- 2) Each student will try to assess his/her peer students program and the possible outputted errors via Eclipse IDE.

2.Explain the relation of your solution to related prior work

You would need to show how your solution is different or better than existing work. Answer:

- Which gap listed above is your solution attempting to address?
- Does your solution extend existing work?

(or)

- Does your work provide an alternative solution?

ANS : Gap analysis in progress

3.Why is your method likely to work?

Defend your solution approach (treatment/tool) using logical arguments. You would have to convince :

- Is your treatment strategy or tool solving the problem?
- Is this treatment even worth experimenting?

ANS :

- 1) Real time evaluation of lab assignments.
- 2) Increase in students meta-cognitive ability thus gaining deeper understanding of the concepts and developing the skills of troubleshooting.
- 3)Peer assessment facilitates gain of feedback, new ideas and solution optimization.
- 4) Improve programming skills of a student.

4. What are the details of your learning materials or tool?

- If your solution is related to instructional strategies:

Describe what you will create as learning materials

- If you are developing a tool:

Describe detailed feature that are relevant to the user.

Describe the architecture/model used.

ANS : Learning material and the tool having collaborative features.

1)Peer Assessment

2) Eclipse IDE having collaborative features : solving programming issues in synchronous environment.

5. What are the boundaries of your solution?

State the boundaries of your solution

The boundaries could be related to:

Domain (for ex: is my strategy /tool applicable to a specific topic/subject)

Sample(for ex: is my strategy/tool targeting a specific group)

Environment or context (for ex: am I assuming that my learning materials are to be used without teacher being present)

...etc

ANS :

1) Domain: computer Science

- Concept : Programming Language(preferably JAVA)

- Tool : Eclipse IDE with collaborative features.

2) Sample : Second year undergraduate students.

3) Context : Experimental Lab Session.

Description of the study

1. What is your Research Design?

ANS :

1) Develop a tool : Update the Eclipse IDE by adding collaborative features to it.

2) Peer Assessment

3) Analysis of :

- How many students use the Collaborative feature of the IDE?

- How many students have got benefited from this tool?

4) Problem solving in a synchronous environment.

Test-cases :

1) Self-assessment of the tool developed:

- Checking the network connection of both the systems for sharing the resources.

- Check the working and integrity of the tool on the system.

- Check if the collaborative feature of tool actually helps in solving the programming issues.

2. What is your sample?

Detail the sample, who are the subjects in your study or users of your tool? How will you select the sample?

ANS :

1) Subject : Second year undergraduate students.

2) Class size :

- divide students in group of two if number of students exceeds 30 to avoid possible chaos.

- experiment on entire batch at one time if the number of students is in the manageable range of

20-30.

3. What is the procedure for your study?

Give sufficient detail about the procedure conducted for your study so that your colleague can replicate it.

ANS:

- 1) Pre test
- 2) Perform the experimental lab session
 - providing problem to students.
 - They have to come up with a solution and implement it individually.
 - After compilation, broadcast the code using the collaborative feature of IDE.
 - They should assess and provide feedback.
- 3) Post test : questionnaire format, exploring the questions related to concepts covered in experimental lab session.

4. What is your research study question?

Recall the rules for framing Research Questions in the session

ANS: Does the use of IDE having collaborative features help in improving the conceptual knowledge and programming skills of the students?

5. What are your measurements?

You would have to answer the following questions:

- What will you measure in your study?
- How can you justify that these measurements are suitable to answer the problem you intend to solve?

ANS :

Student Learning using the tool:

- Programming Skills
- Conceptual understanding of the programming language.

6. What are your instruments?

You would have to describe:

- What are the instruments (such as questionnaires, tests) you will use to collect the data?
- Why are the instruments suitable for your study?
- How robust are the instruments? That is, what kind of reliability and validity test can you show?

ANS :

- 1) Pre test
- 2) Post test
- 3) Questionnaire survey

7.How do you plan to analyze your data?

You will have to answer this question on the following lines:

- Which descriptive statistics could you use to present the data in an organized manner? (such as means, histograms, correlations, etc)
- What analysis could you do to draw inferences, that is, to establish that your idea works? Write statistical tests you will apply, and what exactly you can infer from the test.

ANS:

1) Provide a problem to the students.

2) Pre test

- Lab session using IDE without any collaboration features to solve the given problem.

- Questionnaire survey relating to the problems faced during this lab session.

3) Post test

- Lab session using IDE having collaboration feature to solve the same problem used in pre test.

- Questionnaire survey relating to the problems faced during both pre test and post test.

- A/B Testing for usability of the tool.

- compare both the test results using statistical analysis or t-test.

8.What ethical guidelines will you follow for conducting research with human subjects?

Write what ethical guidelines you will consider (such as asking participants to give informed consent), since you are conducting research with human subjects.

ANS : Taking consent from the students before conducting the experiment.

9. Threats to validity

1) Group/individual student equivalence

- There are chances that in spite of the theoretical concept being taught in class, the student tend to forget it after a certain duration.

2) Solution : the concept to be tested should be taught/revised again prior to the pre test and experiment.

Planning your Research Study

This page helps you in articulating the plan for your educational research study. This follows the Idea Proposal Assignment and hence it is important that you complete IPA before attempting this. The research study plan has three parts: Setting up the Problem, Explanation of Intervention/Solution and Description of the study

Learning Objectives for Object Oriented Programming (OOP) Course:

Students will be able to

- Draw the class diagram for the given problem.
- Apply the concept of inheritance for the given problem

Study Planning Activity:

 [StudyPlanningTemplate - TCE.pdf](#)
[Details](#) [Download](#) 168 KB

The above work is the collaborative work of

TCE Team

Representative : Karthikeyan,

Members : Thangavel, and Prakash.

 Add Discussion

 Add Discussion

 Review Comments
Jkiitb Nov 3, 2015

It would be a good idea for you to write the SPA in text form (as was given in the original page). This would help me in reviewing relevant changes and suggesting possible improvements/literature.

 Comment

 Feedback Comments - 28 Oct
Jkiitb Oct 28, 2015

The feedback comments given during the workshop still holds. Additionally, you may want to think about the following practical problem:

a) Will students discuss using the discussion forum effectively within the lab?

So as advised, you may want to try these out initially in lab sessions and then do the actual experiment. I feel that you will have to design a lot of collaboration instructions, like, In the first two minute Person 1 should read Person 2's post and then respond to it. The Person 2 then responds to build discussion.

If all goes well, you can do this as offline TP assignment also, which would make perfect sense as Wiki enables asynchronous discussions. The instructor can then Share the various results in class and discuss with students. Do check some more papers on various methodologies used for teaching Class and Objects. The SIGCSE conference might be a good source for this.

Also what would make it more unique is if Prakash can repeat this Wiki based TPS in his own course in the next semester. This would give generalizability for the solution and you will get enough data points (2 batch students) which will make the referee read the full paper.

 Comment

Study Planning Template

By

Dr.P.Karthikeyan, Assistant Professor

Mr.M.Thangavel, Assistant Professor

Mr.T.Prakash, Assistant Professor

**Thiagarajar College of Engineering
Madurai, Tamil Nadu**

Learning Objectives for Object Oriented Programming (OOP) Course

Students will be able to

- Draw the class diagram for the given problem.
- Apply the concept of inheritance for the given problem

Section 1

SETUP THE PROBLEM

What problem are you addressing?

①

2

3

4

5

6

7

8

9

10

11

12

13

14

15

16

17

- Students are expected to identify the class hierarchy for the given problem in implementing inheritance concept properly.
- In general, students don't think about the class hierarchy for the given problem while implementing inheritance in the lab classes.

Why is your problem important?

1
2
3
4
5
6
7
8
9
10
11
12
13
14
15
16
17

- Implementing an inheritance concept in a practical class is different from what the engineers do the same in the software industry
- Most of the industries input during recruitment is, to build the engineers industry ready

Summarize gaps in prior related work

1
2
3
4
5
6
7
8
9
10
11
12
13
14
15
16
17

- In the current scenario, students are implementing the inheritance without thinking about the problem and its hierarchical order
- Most of the students are writing inheritance programs even without knowing the relationships among the objects
- Most of the students are not writing the programs based on the proper class design for the given problem

Section 2

DETAIL YOUR SOLUTION

What is your solution approach?

1
2
3
4
5
6
7
8
9
10
11
12
13
14
15
16
17

- The idea is on an instructional strategy that will improve the thinking skills of students in solving the given problem.
- Think-Pair-share is the suitable strategy to address this problem.
- Wiki is the right tool to share the different phases of TPS activity among the large number of students in a class.

Explain the relation of your solution to related prior work

The prior works are,

- 1. Pair Programming (PP), and
- 2. Peer Instruction (PI).

PP is a collaborative technique in which two learner's work together in the lab to solve open programming problems like design, development and testing. It has been shown that PP improves student retention and confidence and quality of programs produced. In PI, learner's work on multiple choice questions aimed at improving conceptual understanding and qualitative reasoning. PI focuses on learner's' reasoning for various answers. TPS allows the posing of open-ended problems such as writing pseudocode, which is not possible with PI and PP. Traditionally, TPS activity will be done through Paper work and physical collaboration. Inorder to measure the performance of each and every team member, Wikispaces will be utilized for the scientific evidence collection.

1
2
3
4
5
6
7
8
9
10
11
12
13
14
15
16
17

Why is your method likely to work?

1 The study will be carried out in Object oriented programming
2 Course.

- 3 • It will be a same group pre-post study

4
5
6 What to measure:

- 7 • Programming using class hierarchy in inheritance (Learning),
8 • Student motivation/interest

9
10
11
12 How to measure:

- 13 • Pre-Post Test (for measuring Learning and motivation),
14 • Programming (Learning- will be measured using a rubric)
15
16
17

What are the details of your learning materials or tool?

1
2
3
4
5
6
7
8
9
10
11
12
13
14
15
16
17

- The intervention will be of discussion type.
- It will test students problem solving skills and concept adaptability analysis skills.
- The questions are structured in such a way that it maps to specific learning objectives across the three phases of the intervention.

What are the boundaries of your solution?

- This intervention is relevant to the courses that demands problem solving and programming skills.
- This strategy is targeting Second year IT students.

1
2
3
4
5
6
7
8
9
10
11
12
13
14
15
16
17

Section 3

PLAN YOUR STUDY

What is your research study question?

1
2
3
4
5
6
7
8
9
10
11
12
13
14
15
16
17

- Does TPS through wiki improve the programming skills using class hierarchy in inheritance?
- Does TPS through wiki motivate learners in writing programs using class hierarchy?

What is your research design?

- Pre test design
- Post test design

1
2
3
4
5
6
7
8
9
10
11
12
13
14
15
16
17

What is your sample?

- 60 students from second year IT programme - OOP course from TCE, Madurai.

1
2
3
4
5
6
7
8
9
10
11
12
13
14
15
16
17

What is the procedure for your study?

The whole class will be divided into groups of 5 students per group. The diversity of students in each group comply to following rule:

- 1 **Pre-test Performance:** 1 no. High + 2 no. Medium + 2 no. Low
- 2 The whole TPS intervention process can be broadly divided into three phases
- 3 after the problem is on the floor.
- 4 **Think Phase:**
- 5 Each Individual need to create a Wiki page to post the identified objects and its
- 6 associated data variables and methods individually.
- 7
- 8 **Pair Phase:**
- 9 Team Members need to utilize Wiki Discussion Forum for,
- 10 - finalizing the identified objects and its members
- 11 - creating the class design diagrams with relations for the given problem and
- 12 write the programs based on the design
- 13 **Share Phase:**
- 14
- 15 Team Members need to post their design and program in the Team home page
- 16 of the wiki.
- 17

What are your measurements?

- Group wise strategy sheet evaluation after each intervention (Score).
- Group wise Design and Program evaluation after each intervention (Score).
- Pre-post survey (Pre survey done)

1
2
3
4
5
6
7
8
9
10
11
12
13
14
15
16
17

What are your instruments?

The instruments used for this study are:

- Suitable problems for inheritance
- Evaluation rubrics for pre and post test
- Survey questionnaire

1
2
3
4
5
6
7
8
9
10
11
12
13
14
15
16
17

Planning your Research Study

This page helps you in articulating the plan for your educational research study. This follows the Idea Proposal Assignment and hence it is important that you complete IPA before attempting this.

The research study plan has three parts: Setting up the Problem, Explanation of Intervention/Solution and Description of the study

Setting up the Problem

Setting up of the problem starts from the teaching-learning goal and then tries to provide characteristics of the problem in terms of related work.

1. What problem are you addressing?

You would need to expand the answer by:

Describe the details of a teaching-learning scenario

In an effect to improve the learning experience of Engineering Chemistry theory course in first year engineering students of all Engineering College, the new innovative virtual chemistry laboratory experiments from Amrita Vishwa Vidyapeetham Virtual Lab designed by Amrita University utilized.

2. Why is your problem important?

You should be able to argue(based on literature survey), or show evidence (using data) that the problem exists for your target population or users.

The traditional Engineering Chemistry laboratory experiments use the chemicals, glassware and instruments to teach the fundamental concept of Engineering Chemistry. There are plenty of virtual chemistry laboratory experiments are available for chemistry students. But my innovative experimental method will introduce the measurement of emf of the unknown electrochemical cells, simple acid-base titrations for the analysis of water quality parameters. The usage of innovative virtual chemistry laboratory experiments were designed to enhance the conceptual understanding, ability to achieve the ABET outcomes, teaching-learning process using of computers and not in routine engineering chemistry laboratory.

3. Summarize gaps in prior work

The engineering chemistry laboratory components cover the traditional experiments realistic applications and are simply designed to reinforce the engineering chemistry theories. But, they may failed to capture the students interest, to exposure to real-world problems or to aid to understand engineering chemistry concepts in better manner.

Explanation of Intervention/Solution

1. What is your solution approach?

Describe the details of your solution approach

A summary of virtual chemistry experiments are given with their requirement as per the first year Mechanical engineering students' engineering chemistry laboratory experiments. Some of the experiments are traditional in nature, but their innovation can be attributed to develop and fill the modern requirements of engineering chemistry concepts in mechanical engineering field.

2. Explain the relation of your solution to related prior work

You would need to show how your solution is different or better than existing work. Answer:

- Which gap listed above is your solution attempting to address?
- Does your solution extend existing work?

(or)

- Does your work provide an alternative solution?

Some of the experiments are traditional in nature, but their innovation can be attributed to develop and fill the modern requirements of engineering chemistry concepts in mechanical engineering field. Hence, the virtual chemistry experiments provides an alternative solution to modern engineering chemistry laboratory because they no need chemicals, glassware, no fire accident and no need of high cost equipments. Finally, it saves laboratory working time in a considerable level.

Literature:

(1) Northrup, S.G.; Western New England Coll., MA, USA, Innovative lab experiences for introductory electrical engineering students, [Frontiers in Education Conference, 2009. FIE '09. 39th IEEE.](#) DOI: [10.1109/FIE.2009.5350545](#)

(2) <http://www.abet.org> "2007-2008 Criteria for Accrediting Engineering Programs", E001 07-08 Criteria 11-15-06.pdf

(3) Huettel, L., Brown, A., Collins, L., Coonley, K., Gustafson, M., Kim, J., and Ybarra, G, "A Novel Introductory Course for Teaching the Fundamentals of Electrical and Computer Engineering", *Proceedings of the 2006 American Society for Engineering Education Annual Conference & Exposition, June 19-21, Chicago, IL*

(4) Chi-Un Lei; So, H.K.-H.; Lam, E. Y.; Wong, K.K.; Kwok, R. Y.; Chan, C.K.Y. "Teaching introductory electrical engineering: Project-based learning experience", *Teaching, Assessment and Learning for Engineering (TALE)*, 2012 IEEE International Conference on, On page(s): H1B-1 - H1B-5

(5) Sivaramakrishnan, S.; Ganago, A. "Teaching strategy focused on sensory perception, students' interest and enjoyment: Successful application in Electrical Engineering (EE) lab for non-EE majors", *Frontiers in Education Conference, 2013 IEEE*, On page(s): 296 - 302

3. Why is your method likely to work?

Defend your solution approach (treatment/tool) using logical arguments. You would have to convince :

- Is your treatment strategy or tool solving the problem?
- Is this treatment even worth experimenting?

Some of the experiments are traditional in nature, but their innovation can be attributed to develop and fill the modern requirements of engineering chemistry concepts in mechanical engineering field. Hence, the virtual chemistry experiments provides an alternative solution to modern engineering chemistry laboratory because they no need chemicals, glassware, no fire accident and no need of high cost equipments. Finally, it saves laboratory working time in a considerable level.

4. What are the details of your learning materials or tool?

- If your solution is related to instructional strategies:

Describe what you will create as learning materials

- If you are developing a tool:

Describe detailed feature that are relevant to the user.

Describe the architecture/model used.

The virtual chemistry experimental tool was developed by Amerta University which describe the following for each virtual experiment:

Theory for the virtual laboratory experiments

1. The detailed experimental procedure
2. The animation video for the particular experiment
3. The simulator which will do the virtual experiment
4. The assignment questions for each virtual experiment
5. The feedback from the virtual experiment

5. What are the boundaries of your solution?

State the boundaries of your solution

The boundaries could be related to:

Domain (for ex: is my strategy /tool applicable to a specific topic/subject)

Sample(for ex: is my strategy/tool targeting a specific group)

Environment or context (for ex: am I assuming that my learning materials are to be used without teacher being present)

...etc

The virtual chemistry laboratory experiments are focused on engineering chemistry applications but it can be utilised for any undergraduate students who have chemistry laboratory in their curriculum. This virtual chemistry laboratory experiments can be taken by any students with some prior knowledge of classroom chemistry or even from a simple and fundamental chemistry text books.

Description of the study

1. What is your Research Design?

Does the virtual chemistry laboratory experiment developed by Amirtha University improve the engineering chemistry conceptual understanding of first year engineering students?

What are student perceptions about learning from virtual chemistry laboratory experiments?

What are the differences in conceptual understanding in students with virtual laboratory experience?

2. What is your sample?

Detail the sample, who are the subjects in your study or users of your tool? How will you select the sample?

The 72 first year Mechanical engineering and Civil engineering students are selected based on their computer proficiency. They are given the engineering chemistry related concepts in theory classes. The selection of the virtual chemistry laboratory experiments designed by Amirtha University selected because of its user-friendly nature to all students who study chemistry in their curriculum.

3. What is the procedure for your study?

Give sufficient detail about the procedure conducted for your study so that your colleague can replicate it.

The selected 72 first year students were classified into two groups and their performance of understanding can be tested and compared with pre-test and post-test values in the engineering chemistry concepts.

4. What is your research study question?

Recall the rules for framing Research Questions in the session

Does the virtual chemistry laboratory experiments really increasing the level of understanding?

How much the virtual laboratory experiments are easier to do and understand the engineering chemistry concepts?

Are they are Eco-friendly way to carry out laboratory experiments?

Are they save your time with better understanding?

Are you need any laboratory assistant to assist you when you do the virtual laboratory experiments?

5. What are your measurements?

You would have to answer the following questions:

- What will you measure in your study?
- How can you justify that these measurements are suitable to answer the problem you intend to solve?

Explanation of Intervention/Solution

1. What is your solution approach?

The idea is on an TPS instructional strategy that will improve the ability of learner's to solve real time problems using Structures they have already learned and also translate it to a Pseudocode.

The learner's are expected to collaborate.

The whole TPS intervention process can be broadly divided into three phases after the problem is on the floor through wikispaces are as follows,

- Think Phase (Individual Activity)
- Pair Phase: (Team Activity)
- Share Phase: (Group Activity)

All three phases are constantly supported by instructors prompt from instructor independently to each group

2. Explain the relation of your solution to related prior work

The prior works are,

1. Pair Programming (PP), and
2. Peer Instruction (PI).

PP is a collaborative technique in which two learner's work together in the lab to solve open programming problems like design, development and testing. It has been shown that PP improves student retention and confidence and quality of programs produced.

In PI, learner's work on multiple choice questions aimed at improving conceptual understanding and qualitative reasoning. PI focuses on learner's reasoning for various answers.

TPS allows the posing of open-ended problems such as writing pseudocode, which is not possible with PI and PP.

Traditionally, TPS activity will be done through Paper work and physical collaboration.

Inorder to measure the performance of each and every team member, Wikispaces will be utilized for the scientific evidence collection.

3. Why is your method likely to work?

Defend your solution approach (treatment/tool) using logical arguments. You would have to convince :

Is your treatment strategy or tool solving the problem?

Is this treatment even worth experimenting?

Question prompts from instructor in the intermediate phases develop interest among students and they don't lose track because of high complexity of the problem.

The study will be carried out in Second Semester C programming Course.

It will be a same group pre-post study

What to measure:

Problem Solving using Structures (Learning), Student motivation/interest

How to measure:

- Pre-Post Test (for measuring Learning and motivation).
- Pseudocode (Learning- will be measured using a rubric)

4. What are the details of your learning materials or tool?

If your solution is related to instructional strategies:

Describe what you will create as learning materials

If you are developing a tool:

Describe detailed feature that are relevant to the user.

Describe the architecture/model used.

The questions posed by the instructor through Wiki Discussion Forum, during the intervention will be of discussion type.

It will test students problem solving skills and concept adaptability analysis skills.

The questions are structured in such a way that it maps to specific learning objectives across the three phases of the intervention.

5. What are the boundaries of your solution?

State the boundaries of your solution

The boundaries could be related to:

Domain (for ex: is my strategy /tool applicable to a specific topic/subject)

Sample(for ex: is my strategy/tool targeting a specific group)

Environment or context (for ex: am I assuming that my learning materials are to be used without teacher being present) ...etc

This intervention is relevant to subjects that demands problem solving and programming skills to solve given real time scenario.

This strategy is targeting Second Semester - First Year engineering Students.

Description of the study

1. What is your Research Design?

Pre-Test Design

Post-Test Design

2. What is your sample?

Detail the sample, who are the subjects in your study or users of your tool? How will you select the sample?

The sample for this study are First Year - Second Semester engineering undergraduate students.

70 First Year - Second Semester undergraduate students of C Programming Course, Thiagarajar college of Engineering, Madurai.

3. What is the procedure for your study?

Give sufficient detail about the procedure conducted for your study so that your colleague can replicate it.

The study will be carried out in a C-Programming class of 70 students. The whole class will be divided into groups of 5 students per group. The diversity of students in each group comply to following rule:

Pre-test Performance:

1 no. High + 2 no. Medium + 2 no. Low

The whole TPS intervention process can be broadly divided into three phases after the problem is on the floor.

Think Phase:

Each Individual need to create a Wiki page to post the identified structures and variables individually.

Pair Phase:

Team Members need to utilize Wiki Discussion Forum for,

- finalizing the identified Structures and variables
- creating the pseudocode for the given problem

Share Phase:

Team Members need to post their Pseudocode in the Team Wikipage of Structure Wiki Project.

4. What is your research study question?

Recall the rules for framing Research Questions in the session

Does Think-Pair-Share through Wikispaces improves problem solving skills using Structures?

Does Think-Pair-Share through Wikispaces motivate learner's in writing Pseudocode?

5.What are your measurements?

You would have to answer the following questions:

What will you measure in your study?

How can you justify that these measurements are suitable to answer the problem you intend to solve?

Group wise strategy sheet evaluation after each intervention (Score).

Group wise Pseudocode evaluation after each intervention (Score).

Pre-post survey (Pre survey done)

6. What are your instruments?

You would have to describe:

What are the instruments (such as questionnaires, tests) you will use to collect the data?

Why are the instruments suitable for your study?

How robust are the instruments? That is, what kind of reliability and validity test can you show?

The instruments used for this study are:

- Real time problems
- Survey Questionnaire

7.How do you plan to analyze your data?

You will have to answer this question on the following lines:

Which descriptive statistics could you use to present the data in an organized manner? (such as means, histograms, correlations, etc)

What analysis could you do to draw inferences, that is, to establish that your idea works? Write statistical tests you will apply, and what exactly you can infer from the test.

8.What ethical guidelines will you follow for conducting research with human subjects?

Write what ethical guidelines you will consider (such as asking participants to give informed consent), since you are conducting research with human subjects.

The above work is the collaborative work of

TPS Wiki Team

Representative : Karthikeyan,

Members : Thangavel, Prakash and Thangagiri.

 Add Discussion



Feedback Comments - Oct 28

[Jkiitb](#) Oct 28, 2015

Look at the feedback comments provided on TCE_SPA. The same holds good here also.

Additionally for Prof. Thangagiri can think of how he can merge Wikispaces with Virtual laboratory to do a Think-Pair-Share. For e.g. In-class he shows a Virtual lab simulation and then asks students a question related to the experiment. Answer to this is then written by each student in their own page. He then asks them to initiate discussions in Pair to cross-check each other's answer OR give an incremental question for the pairs to work with that requires them to discuss. And finally share the answers. This is only a suggestion and is not mandatory.



[er.mudit Kapoor](#) Nov 3, 2015

I think if you use ISAT, it is a good tool to show results in this (Pre-Post) type of scenarios.



Comment

APPENDIX F – Survey Questionnaires and Rubrics used in Iterations

Iteration 1 – ET4ET₀

Survey Questionnaire

Except for C.3, C.9, the response was on a 5 point Likert Scale from Strongly Disagree to Strongly Agree

For C.3, participants can write the appropriate Bloom's level

For C.9.a, C.9.b and C.9.c, the response was a 5 point Likert Scale from Never to Always

- A.1: I found the course planning activity using concept maps useful for planning my lectures.
A.2: I found the sessions on Learning Objective discussed in the workshop useful.
A.3: I found the session on Think-Pair-Share (TPS) within the workshop useful for planning a TPS for my course.
A.4: I found the sessions on assessment useful in planning assessment strategies for my course.
A.5: I found the sessions on visualizations useful in identifying appropriate visualizations.
A.6: I found the activities conducted in the workshop like TPS or Peer instruction (clicker questions) useful.
A.7: I found the sessions in the workshop to be interesting.
- B.1: I understood how to draw a concept map for my course.
B.2: I understood how to write a Learning Objective at different Bloom's levels
B.3: I understood how to write an Assessment Question at different Bloom's levels.
B.4: I understood how to align the assessment question to the Learning Objective.
B.5: I understood how to use TPS for a given Learning Objective.
B.6: I understood how to write a "Multiple choice Questions for Peer Instruction" (clicker questions) for a given Learning Objective.
B.7: I understood how to use Visualizations or VLab for a given Learning Objective.
B.8: I understood a lot more about the workshop contents through the discussions with other participants.
- C.1: I intend to explicitly specify Learning Objective for my class
C.2: I intend to assign higher level learning objectives for my course
C.3: To which Bloom's cognitive level will you write this higher learning objective for
C.4: I am confident of being able to select appropriate visualization for my course.
C.5: I am confident of teaching with appropriate visualizations within my course.
C.6: I am confident of writing assessment questions that match the Learning objective.
C.7: I am confident of executing Think Pair Share in my course.
C.8: I am confident of writing an MCQ for Peer Instruction (clicker questions) within my course.
C.9: I intend to use:
 a. TPS in my course
 b. MCQ with Peer Discussion
 c. Visualizations

Technology Integration Evaluation Rubric

Levels/Constructs	Missing	Inadequate	Need Improvement	Adequate
Learning Objective (LO)	No attempt for writing a learning objective has been made	The learning objective(s) has been written but does not contain an action verb that relates to a specific measurable performance or even if the verb is present does not specify the students role explicitly. For e.g. "The students will be able to know De Morgans theorem discussed in class" or in the second case it is just "To apply DeMorgans theorem"	Most learning objectives are written correctly but one or more needs clarity on the conditions under which the performance will be carried out For e.g. the LO contains "Students will be able to apply DeMorgan's Theorem to reduce to simplest form" and fails to mention conditions like "for a given logic equation"	The learning objective mentions both when and under what conditions the students will be able to acheive the specific measurable performance. For e.g.: After the first session on De Morgans theorem, the students will be able to apply DeMorgan's theorem and simplify given logic equations.
Instructional Strategy (IS)	No Instructional Strategy mentioned	The lecture plan contains only the name of the instructional strategy that is going to be utilized does not describe how it is going to be implemented or the description is incomplete and inaccurate. For e.g. for IS the lecture plan mentions only TPS	The lecture plan explains how the instructional strategy is going to be implemented but the description is either incomplete or inaccurate. For e.g. for the TPS the strategy explains what happens at each stage of T, P and S but fail to mention at what stage of lecture it is going to be used.	The lecture plan explains clearly how the instructional strategy is going to be used, including the detailed description and the timings involved. For e.g. a TPS strategy is introduced at the start of the class. The T phase extends for x minutes, followed by P phase for y minutes and then S phase for Z minutes

Levels/Constructs	Missing	Inadequate	Need Improvement	Adequate
Alignment of IS with LO	No attempt is made to align the Instructional Strategy with LO	The Instructional strategy does not align with the Learning Objective For e.g. For a create level objective of writing a code to achieve a functionality, the TPS activity makes student debug a program.	The Instructional Strategy has been aligned with the Learning Objective however it does not mention clearly what students will do For e.g. In TPS for the create level LO, the student activity fails to mention that students discuss various modules with each other in pair/share phase.	The instructional strategy is aligned to the level of learning objective and all the activities performed by students are mentioned clearly. For e.g. In the Pair phase, the students discuss each other's modules to come up with an integrated module for share phase.
Assessment Strategy	No Assessment Strategy Mentioned	The lecture plan just mentions the questions that are going to be used and does not describe how it is going to be implemented or the description is incomplete or inaccurate. For e.g. Draw V-I Characteristics of diode	The lecture plan explains how the assessment is going to be implemented within the lecture but the questions are ambiguous. For e.g. after the end of topic on diode, I will ask them to draw the V-I characteristics of diode.	The lecture plan contains how and when the assessment will be done within the lecture and the questions are spelt out clearly. For e.g: after the end of topic on diode, I will ask them to draw the V-I characteristics of reverse-biased diode.

Levels/Constructs	Missing	Inadequate	Need Improvement	Adequate
Alignment of AS with LO	No attempt is made to align the Assessment Strategy with Learning Objective	The Assessment strategy either does not align with the Learning Objective at all or very few are aligned. For e.g. For a create level LO, the assessment activity has more questions Apply/Analyze level.	Most of the questions are aligned with the Learning objective however a few are not aligned. For e.g. almost 80% of the questions are at the level described in Learning Objective but remaining 20% gets completely misaligned.	All the questions are aligned with the learning objectives.
Alignment of IS with AS	No attempt is made to align the Instructional Strategy with Assessment Strategy	Most of the Instructional strategies do not align with the Assessment strategy or vice versa. For e.g. The students are asked about design of a circuit when the instructional strategy covered only the components of the circuit.	Some of the Instructional strategies are not aligned with the Assessment strategy or vice versa. For e.g. The students are detailed about how to choose a specific component for the circuit during the instruction and analyze its performance. In the assessment questions there are lot of questions related to analysis of performance of various components however there is none at evaluate level for choosing the component.	All the questions are aligned with the instructional strategies.

Iteration 2 – ET4ET₁

Survey Questionnaire

For Q1 to Q18 and Q22, the response was on a 5 point Likert Scale from Strongly Disagree to Strongly Agree

For Q19 to Q21, the response was on a 4 point Likert Scale from Poor to Very Good

For Q23, they have to indicate the month that they preferred for training

- Q1. I learnt how to setup learning objectives and matching assessment after attending this workshop
- Q2. I intend to specify learning objectives and match the assessments in my course this semester.
- Q3. I learnt about the various technology tools that are useful for me in the session on Digital Blooms Taxonomy (Day4-AM1)
- Q4. The contents discussed during workshop session on Wikis were highly useful for me.
- Q5. I learnt how to set up a wiki-based activity for my course from the sessions on Wiki
- Q6. I am planning to use wikis in my course in the coming semesters
- Q7. The online session and activities on Peer Instruction (PI) were highly useful for me to plan PI activities in my own class.
- Q8. The online session and activities on Think-Pair-Share (TPS) were highly useful for me to plan TPS activities in my own class.
- Q9. The online session and activities on Flipped Classroom were highly useful for me to plan a flipped classroom activity for my own course.
- Q10. The online session and activities on Visualization were highly useful for me to plan a Visualization based activity for my own course.
- Q11. I learnt how to set up a Peer Instruction activity in my class through the moodle activities and assignment on Peer Instruction.
- Q12. I learnt how to set up a Think-Pair-Share activity in my class through the moodle activities and assignment on TPS.
- Q13. I learnt how to set up a Flipped classroom activity in my course through the sessions on Flipped Classroom.
- Q14. I learnt how to use Visualizations along with an Active Learning strategy in my course through the sessions on Lesson Plan using Visualization.
- Q15. I intent to use Peer Instruction activities in my course in the coming semesters.
- Q16. I intent to use Think-Pair-Share activities in my course in the coming semesters.
- Q17. I intent to use Visualization based activities in my course in the coming semesters.
- Q18. I intent to use Flipped Classroom mode of teaching-learning in my course in the coming semesters.
- Q19. How would you rate the Synchronous Session-Phase I (June 12- June 14)
- Q20. How would you rate the Online Session (June 15- July 23: Week 1 to Week5)
- Q21. How would you rate the Synchronous Session-Phase II (July 24- July 26)
- Q22. Overall I am satisfied with the workshop
- Q23. What would be a preferred month for you to conduct similar workshops in the future? (You can indicate more than 1 option)
- Q24. If you have any other comments about the format or content of the workshop, please write them here.

Wiki Competency Questionnaire

The questions for this survey have been adapted from Technology Self Proficiency Questionnaire (Milman, Nortecamp & Mills, 2012).

For Q1-Q8, the response used a 4-point Likert Scale from “I cannot do this” to “I can teach this to others”

- Q1. Find wiki softwares to support teaching and student learning.
- Q2. Design lessons that utilize Wikis to develop students' higher order thinking skills.
- Q3. Teach lessons that use wiki to meet the individual needs of the students.
- Q4. Teach in environments that range from one-computer classrooms to networked computer labs.
- Q5. Find technology resources to support evaluation of student learning.
- Q6. Use Wiki based strategies to evaluate student learning. (e.g. Create space for Review articles/assignments)
- Q7. Evaluate artifacts created by students using wiki.
- Q8. Guide students in the development of rubrics to evaluate the products developed using wiki.

Are you willing to participate in the research by providing this data?

Iteration 3 – ET4ET₂

Technology Familiarity Survey

The survey was administered to understand familiarity with five technology tools. The response was taken on a 4 point Likert scale from “Not at all” to “I have used it in my course”

Q1: Indicate your familiarity with the following technology tools:

T1 – Powerpoint

T2 – Video Lectures

T3 – Screencasts

T4 – Wiki

T5 – Interactive Visualizations

Q2: Other than the listed tools, mention the other technology tools that you commonly use in your class

Technology Competency Survey Questionnaire

The questions for this survey have been adapted from Technology Self Proficiency Questionnaire (Milman, Nortecamp & Mills, 2012).

The response to the question used a 4-point Likert Scale from “I cannot do this” to “I can teach this to others

In the following questions, the word "Technology" refers to - Use of Videos, Animations, Simulations, Wikis, Blogs/Forums, LMS etc. and not just simple use of Powerpoint and projectors.

Q1. Find technology resources to support teaching and student learning.

Q2. Design lessons that utilize technology to develop students' higher order thinking skills.

Q3. Teach lessons that use technology to meet the individual needs of the students.

Q4. Teach in environments that range from one-computer classrooms to networked computer labs.

Q5. Find technology resources to support evaluation of student learning.

Q6. Use technology based strategies to evaluate student learning. (e.g. Conduct an online quiz)

Q7. Evaluate artifacts created by students using technology.

Q8. Guide students in the development of rubrics to evaluate the products developed using technology.

Based on your confidence of handling ICT tool - Video Lectures, within your teaching-learning practice, kindly answer whether you will be able to

Q9. Find Video Lectures to support teaching and student learning.

Q10. Design lessons that utilize Video Lectures to develop students' higher order thinking skills.

Based on your confidence of handling ICT tool - Screencasts, within your teaching-learning practice, kindly answer whether you will be able to

Q11. Design lessons that utilize Screencasts to develop students' higher order thinking skills.

Q12. Evaluate Screencasts created by students using technology.

Based on your confidence of handling ICT tool - Wiki, within your teaching-learning practice, kindly answer whether you will be able to

Q13. Design lessons that utilize Wikis to develop students' higher order thinking skills.

Q14. Evaluate Screencasts created by students using technology.

Based on your confidence of handling ICT tool - Visualizations, within your teaching-learning practice, kindly answer whether you will be able to

Q15. Find visualizations to support my teaching and student learning

Q16. Design lessons that utilize Visualizations to develop students' higher order thinking skills.

Wiki based lesson plan evaluation Rubric

	TARGET	SATISFACTORY	INADEQUATE
C1 - Student-centeredness of instructional strategy	All strategies mentioned require active student participation, beyond mere listening or copying of notes or answering questions.	Majority of strategies require active student participation; however there are a few in which students are passive listeners or there is no clear description of student role.	Majority of strategies do not require active student participation or there is no clarity on the roles of students in these strategies.
C2 - Alignment between learning objectives and instructional strategy	There is a perfect alignment between all the learning objectives and the instructional strategies.	Most instructional strategies are aligned with learning objectives, however there are a few which are not aligned or not clearly explained	Majority of the strategies are not aligned with the stated learning objectives or there is no clarity on how the strategies are going to be used
C3-Alignment between assessment and learning objectives	All assessment questions are aligned with the stated learning objectives.	Majority of assessment questions are aligned with stated learning objectives, however there are a few which are not aligned or unclear.	Majority of assessment questions are not aligned with the learning objectives or there is no clarity on how the assessment is to be implemented.

End of Training Feedback Survey

For Q1 to Q17 and Q20, the response was on a 5 point Likert Scale from Strongly Disagree to Strongly Agree

For Q18 and Q19, the response was on a 4 point Likert Scale from Poor to Very Good

For Q21, they can give their consent by selecting Yes/No

For Q22, they have to indicate the month that they preferred for training

- Q1. I learnt how to setup learning objectives and matching assessment after attending this workshop
- Q2. I intend to specify learning objectives and match the assessments in my course this semester.
- Q3. I learnt about the various technology tools that are useful for me in the session on Digital Blooms Taxonomy (Day2-AM2)
- Q4. The contents discussed during workshop session on Wikis were highly useful for me.
- Q5. I am planning to use wikis in my course in the coming semesters
- Q6. The lab session and activities on Peer Instruction (PI) were highly useful for me to plan PI activities in my own class.
- Q7. The lab session and activities on Think-Pair-Share (TPS) were highly useful for me to plan TPS activities in my own class.
- Q8. The online session and activities on Flipped Classroom were highly useful for me to plan a flipped classroom activity for my own course.
- Q9. The online session and activities on Visualization were highly useful for me to plan a Visualization based activity for my own course.
- Q10. I learnt how to set up a Peer Instruction activity in my class through the moodle activities and assignment on Peer Instruction.
- Q11. I learnt how to set up a Think-Pair-Share activity in my class through the moodle activities and assignment on TPS.
- Q12. I learnt how to set up a Flipped classroom activity in my course through the sessions on Flipped Classroom.
- Q13. I learnt how to use Visualizations along with an Active Learning strategy in my course through the sessions on Lesson Plan using Visualization.
- Q14. I intent to use Peer Instruction activities in my course in the coming semesters.
- Q15. I intent to use Think-Pair-Share activities in my course in the coming semesters.
- Q16. I intent to use Visualization based activities in my course in the coming semesters.
- Q17. I intent to use Flipped Classroom mode of teaching-learning in my course in the coming semesters.
- Q18. How would you rate the Synchronous Session-Phase I (Jan 5- Jan 7)
- Q19. How would you rate the Synchronous Session-Phase II (Jan 19- Jan 21)
- Q20. Overall I am satisfied with the workshop
- Q21. Do you give your consent for us to use these data for academic research activities.
- Q22. What would be a preferred month for you to conduct similar workshops in the future? (You can indicate more than 1 option)
- Q23. If you have any other comments about the format or content of the workshop, please write them here.

APPENDIX G – THEMATIC ANALYSIS

SI No	What are the observed changes in your teaching-learning practice	Open Coding Round 1	Open Coding Round 2	Axial Codes (Themes)	Level
1	to use Teaching-Learning strategies	Teacher's Practice	Teacher's Practice of Strategy	Teacher Practice of Programme Content	Teacher level
2	use more visualization	Teacher's Practice in Use of Technology	Teacher's Practice in Use of Technology	Teacher Practice of Programme Content	Teacher level
3	Great!	Teacher Belief	Can't Say		
4	Up to our workshop my Syllabus was completed.	NA	NA		
5	The enthusiasm of atleast 50 percent student was very interesting.	Students engagement	Students Participation or Engagement	Students' engagement	Student Level
6	Understanding level was good those who were actively involved in the activities.	Student learning; Teacher Learning of ped	Stdudents' actual learning	Students' learning	Student Level
7	Understanding level was good those who were actively involved in the activities.		Teacher learning of workshop content	Teacher Learning of Programme Content	Teacher level
8	I tried TPS activity.	Teacher's Practice	Teacher's Practice of Strategy	Teacher Practice of Programme Learning	Teacher level
9	As we had short span of time during the previous semester, we could not practice all of the activities we learnt.	NA	NA		
10	But we planned to implement in the forthcoming semester.	Teacher Belief	Teacher Intention for practice	Teacher Intention to sustain	Teacher level
11	Also, we disseminate the methodology to our faculty members.	Dissemination within Institution	Dissemination within Institution		Institution level
12	Students participation/ concentration in the class increased.	Students engagement	Students Participation or Engagement	Students' engagement	Student Level
13	They[Students] are willingly agreeing to accept various Educational Technologies.	Students belief	Students Belief towards Teacher Practices	Students' change in belief	Student Level
14	Students are more focused about the Learning Objectives.	Teacher Attitude; Student behaviour	Teachers attitude shift in TL practices	Teacher's attitude shift in TL practices	Teacher level
15	Students are more focused about the Learning Objectives.		Student behaviour	Students' change in attitude	Teacher level
16	Interactive Sessions	Students engagement	Students engagement	Students' engagement	Student Level
17	More interest towards the course	Students belief	Students Belief towards Teacher Practices	Students' change in attitude	Student Level
18	Learned and Facilitated	Teacher's learning	Teacher's learning of Programme content	Teacher Learning of Programme Content	Teacher level
19	Comfortable	Teacher's Ease of practice	Teacher's Practice of Strategy	Teacher Practice of Programme Content	Teacher level
20	I feel that giving activities to the students in the class room to keep them engaged is very important and it also makes the class very interesting.	Reinforcement of Teacher Learning about Pedagogy	Teacher attitude shift in TL practices	Teacher's attitude shift in TL practices	Teacher level

SI No	What are the observed changes in your teaching-learning practice	Open Coding Round 1	Open Coding Round 2	Axial Codes (Themes)	Level
21	I feel that giving activities to the students in the class room to keep them engaged is very important and it also makes the class very interesting.		Students' engagement	Students' engagement	Student Level
22	Not only that we also conducted a training programme for about 120 faculty members out of 350 in our College and shared the important topics of this workshop.	Dissemination within Institution	Dissemination within Institution	Practices at Institution level	Institution level
23	Though all the topics are important due to want of time we covered only a few topics and we also gave them assignments.	NA	NA	NA	
24	We have also planned to conduct another phase of this workshop to convey all the topics in the near future.	Sustenance within Institution	Sustenance within Institution	Practices at Institution level	Institution level
25	Also we have started using Moodle in our Institute for conducting quiz, surveys and for assignments.	Teacher's Practice in Use of Technology	Teacher's Practice in Use of Technology	Teacher Practice of Programme Content	Teacher level
26	Hats off to your team for the trigger you have given to us to make improvements in our pedagogy!	Teacher Belief of Learning	Teachers Change of Attitude and Belief	Teachers Change in Attitude and Belief	Teacher level
27	Ultimately, the teaching-learning process is made more effective after attending the Pedagogy Workshop.	Teacher Belief of Learning	Teachers' learning of workshop content	Teacher Learning of Programme Content	Teacher level
28	We got very good feedback.	Teacher Self Evaluation	Teacher Self Evaluation	Teacher Self Evaluation	Teacher level
29	I am able to make students to concentrate on subject well and make class more interactive.	Student learning;	Student learning	Students' learning	Student Level
30	I am able to make students to concentrate on subject well and make class more interactive.		Teacher Self Evaluation	Teacher Self Evaluation	Teacher level
31	Paper setting is improved after attending the workshop.	Teacher practice of assessment	Teacher practice of assessment	Teacher Practice of Programme Content	Teacher level
32	Understood the designing wiki activity.	Teacher's belief of learning of tool	Teachers belief of learning of Workshop content	Teacher Learning of Programme Content	Teacher level
33	Understood the Taxonomy.	Teacher Belief of Learning	Teachers' belief learning of Workshop content	Teacher Learning of Programme Content	Teacher level
34	Understood , how to use the technical tools in a class rooms.	Teacher's belief of learning of tool integration	Teacher's belief of learning of tool integration	Teacher Learning of Programme Content	Teacher level
35	Understood , how to refer the videos for particular subject.	Teacher's belief of learning of a tool integration	Teacher's belief of learning of a tool integration	Teacher Learning of Programme Content	Teacher level
36	Overall the workshop was very good. We learned a lot from this.	Teacher Belief of Learning	Teachers' learning of workshop content	Teacher Learning of Programme Content	Teacher level
37	Content is delivered very effectively	Teacher Self Evaluation	Teacher Self Evaluation	Teacher Self Evaluation	Teacher level
38	TPS activity is carried very effectively with tiny failures	Teacher's Practice; Teacher Self Evaluation	Teacher's Practice	Teacher Practice of Programme Content	Teacher level
39	TPS activity is carried very effectively with tiny failures		Teacher Self Evaluation	Teacher Self Evaluation	Teacher level

SI No	What are the observed changes in your teaching-learning practice	Open Coding Round 1	Open Coding Round 2	Axial Codes (Themes)	Level
40	All the activities taught were implemented only once due to the below problems, though the class was active.	Students engagement;	Students engagement	Students' engagement	Student Level
41	All the activities taught were implemented only once due to the below problems, though the class was active.		Teacher Self evaluation (-ve)	Teacher facing issues in implementation	Teacher level
42	For PI and TPS questions , even after combining the students into group ,30% of the students were inactive.	Teacher Self Evaluation (-ve)	Teacher Self Evaluation (-ve)	Teacher facing issues in implementation	Teacher level
43	For flipped class room activity 70% of the students they did not do their part.	Teacher Self Evaluation (-ve)	Teacher Self Evaluation (-ve)	Teacher facing issues in implementation	Teacher level
44	This due to management students who used to memorize the steps and do not go deep into problem solving	Teacher Conception of Students and Pedagogy	Teacher's existing beliefs	Teacher's existing beliefs	Teacher level
45	Over all my experience with the change in teaching methodology is: Active class room, Concept understanding	Student learning;	Student learning	Students' learning	Student Level
46	Over all my experience with the change in teaching methodology is: Active class room, Concept understanding		Teacher Self Evaluation	Teacher Self Evaluation	Teacher level
47	Over all my experience with the change in teaching methodology is: Active class room, Concept understanding		Student Engagement	Students' engagement	Student Level
48	But still they don't sit themselves and try solving the problem.	Teacher Conception of Students	Teacher's existing beliefs	Teacher's existing beliefs	Teacher level
49	This is due to easy way of getting pass marks in the University examination, i.e.	Teacher Conception of System	Teacher's existing beliefs	Teacher's existing beliefs	Teacher level
50	But I believe over the period they may change and ICT enabled teaching methodology will be fruitful in future if we follow it regularly.	Teacher Belief about change; Teacher intention to sustain	Teacher Belief about change	Teachers Change in Attitude and Belief	Teacher level
51	But I believe over the period they may change and ICT enabled teaching methodology will be fruitful in future if we follow it regularly.		Teacher intention to sustain	Teacher Intention to sustain	Teacher level
52	Good.	Teacher Belief	Can't Say		
53	I have applied some new and innovative methodology	Teacher's Practice; teacher Interest	Teacher's Practice of pedagogy	Teacher Practice of Programme Content	Teacher level
54	Used flipped classroom, TPS, screencast	Teacher Practice of Technology; Teacher Practice	Teacher Practice of Technology	Teacher Practice of Programme Content	Teacher level
55	Used flipped classroom, TPS, screencast		Teacher Practice of strategy	Teacher Practice of Programme Content	Teacher level
56	Many students in class, especially those coming from rural and under-privileged groups say that they do not have easy access to the internet.	NA	NA		
57	More efficiency	Teacher Self Evaluation	Teacher Self Evaluation	Teacher Self Evaluation	Teacher level

SI No	What are the observed changes in your teaching-learning practice	Open Coding Round 1	Open Coding Round 2	Axial Codes (Themes)	Level
58	all student are active and fell good	Student Engagement; Teacher Self Evaluation	Student Engagement	Students' engagement	Teacher level
59	all student are active and fell good		Teacher Self Evaluation	Teacher Self Evaluation	Teacher level
60	I have adopted soo many new techniques in my teaching after attending pedagogy workshop.	Teacher's Practice of pedagogy	Teacher's Practice of pedagogy	Teacher Practice of Programme Content	Teacher level
61	In each class i am successfull in grabbing the attention of every student in the class by making them to involve in one or the other activity	Student Engagement; Teacher Self Evaluation, Teacher's Practice of pedagogy	Student Engagement	Students' engagement	Student Level
62	In each class i am successfull in grabbing the attention of every student in the class by making them to involve in one or the other activity		Teacher Self Evaluation	Teacher Self Evaluation	Teacher level
63	In each class i am successfull in grabbing the attention of every student in the class by making them to involve in one or the other activity		Teacher's Practice of pedagogy	Teacher Practice of Programme Content	Teacher level
64	pedagogy workshop helped me lot for my teaching i have used all the strategies that were teached in pedagogy workshop for designing flipped class room, tps activity , wikispaces all helped me lot for my excellent teaching thanks for that feeling happy	Teacher's Practice of pedagogy	Teacher Practice of Technology	Teacher Practice of Programme Content	Teacher level
65	pedagogy workshop helped me lot for my teaching i have used all the strategies that were teached in pedagogy workshop for designing flipped class room, tps activity , wikispaces all helped me lot for my excellent teaching thanks for that feeling happy		Teacher Practice of pedagogy	Teacher Practice of Programme Content	Teacher level
66	I was able to concentrate more on the content rather than a syllabus oriented class.	Change in Teacher's Practice of pedagogy	Teachers attitude shift	Teacher Shift in Attitude	Teacher level
67	PI and TPS was success	Teachers practice; Teachers Self evaluation	Teachers practice;	Teacher Practice of Programme Content	Teacher level
68	PI and TPS was success		Teachers Self evaluation	Teacher Self Evaluation	Teacher level
69	I was able to engage the backbenchers with the activities and that was reflected in their exam results.	Student engagement; Student learning;	Student engagement	Students' engagement	Student Level
70	I was able to engage the backbenchers with the activities and that was reflected in their exam results.		Student learning	Students' learning	Student Level
71	Participation of almost all the students in he class	Student engagement	Student engagement	Students' engagement	Student Level
72	Enhances group learning	Student Collaboration improved	Student Collaboration improved	Students' collaboration	Student Level
73	its very much useful for improve my teaching skills	Reflection about teaching skills	Reflection about teaching skills	Teacher Self Evaluation	Teacher level

SI No	What are the observed changes in your teaching-learning practice	Open Coding Round 1	Open Coding Round 2	Axial Codes (Themes)	Level
74	After attending the work shop, i learn to measure the student's perspective for a particular topic.	Student assessment improved; Teachers change in attitude towards TL practices	Student assessment improved	Students' learning	Student Level

ACKNOWLEDGEMENT

First and foremost, I wish to express my utmost gratitude and heartfelt appreciation to both my research advisors, **Prof. Sahana Murthy and Prof. Sridhar Iyer**, for their guidance, continuous support, motivation and discussions throughout the course of my research work. Without my supervisor's advice this thesis would not have been possible. I thank **Prof. Kannan Moudgalya and Prof. Chetan Solanki** for their valuable comments that helped to improve my research work. Both of their experience with helming large-scale projects have been instrumental in helping me to explore solutions to the research and implementation challenges that they had cautioned me during my yearly progress reviews. I am grateful to all the instructors who agreed to participate in my studies. Their feedback helped me improve the A2I2 Model. I take the privilege to acknowledge my senior colleagues **Dr. Madhuri Mavinkurve, Dr. Mrinal Patwardhan, Ms. Rekha Ramesh and Ms. Anita Diwakar**, with whom I worked closely to develop the first iteration of A2I2 model and the subsequent training. I also acknowledge the support and guidance provided by **Dr. Gargi Banerjee**, who was working in improving lesson design practices of engineering college teachers while using visualizations. A lot of the insights and learnings from her research has been integrated in the sessions related to visualizations in my training programmes. I would also like to acknowledge **Prof. Deepak B Phatak** who is the driving force behind the T10kT and IITBombayX projects, and without whose vision I would not have obtained a well established network of network of colleges participating in these trainings. I would also like to thank the entire T10kT team and IITbombayX team for the support extended to me during the entire span of this research.

I would like to especially acknowledge the support provided by **Mr. Rwitajit Majumdar**, not just for providing me with the neat and clean graphics for the model, but also being a kind and considerate roomie during the academic year 2014-15. My special thanks to my colleagues and friends Ms. Aditi Kothiyal, Mr. Shitanshu Mishra, Mr. Kapil Kadam, Dr. Yogendra Pal for lending their patient ears and providing me with deeper thoughts both on research and life. I thank all ET research scholars who encouraged me through constructive feedback throughout my research

work. My special thanks to the staff of Educational Technology and CDEEP, IIT Bombay for helping me navigate the academic processes effortlessly throughout this research.

Last but not the least, I would like to acknowledge the support provided by my family, for being there for me throughout this journey. A special mention and highlight for the struggles and sacrifices born by my better half, Ms. Sreelakshmi C, for managing the homefront. She had ensured that my motivation and interest did not diminish throughout the latter half of this journey. I take privilege to thank all the people who helped and supported me directly or indirectly throughout my academic career.

Jayakrishnan M

May 31, 2018